

**Canon**

# EOS R5



Advanced User Guide

**E**

# Contents

---

Introduction	9
Package Contents	10
Instruction Manuals	12
Quick Start Guide	13
About This Guide	17
Compatible Cards	19
Safety Instructions	20
Handling Precautions	23
Part Names	27
Software	41
Preparation and Basic Operations	45
Charging the Battery	46
Inserting/Removing Batteries	49
Inserting/Removing Cards	52
Using the Screen	59
Turning on the Power	61
Attaching/Detaching RF Lenses	65
Attaching/Detaching EF/EF-S Lenses	69
Using the Viewfinder	73
Basic Operations	74
Menu Operations and Settings	89
Quick Control	95
Touch-Screen Operation	96
Shooting Mode	98
A+: Fully Automatic Shooting (Scene Intelligent Auto)	99
A+: Fully Automatic Techniques (Scene Intelligent Auto)	103
Fv: Flexible-Priority AE	106
P: Program AE	109
Tv: Shutter-Priority AE	112
Av: Aperture-Priority AE	115

M: Manual Exposure.....	119
BULB: Long (Bulb) Exposures.....	122
Shooting and Recording.....	126
Still Photo Shooting.....	127
Tab Menus: Still Photo Shooting.....	129
Image Quality.....	135
Dual Pixel RAW.....	141
Still Photo Cropping/Aspect Ratio.....	143
Auto Exposure Bracketing (AEB).....	147
ISO Speed Settings for Still Photos.....	149
HDR PQ Settings.....	157
Auto Lighting Optimizer.....	161
Highlight Tone Priority.....	163
Anti-Flicker Shooting.....	164
Shooting with Speedlites.....	166
Flash Function Settings.....	170
White Balance.....	183
White Balance Correction.....	192
Color Space.....	196
Picture Style Selection.....	197
Picture Style Customization.....	201
Picture Style Registration.....	205
Clarity.....	208
Lens Aberration Correction.....	209
Long Exposure Noise Reduction.....	216
High ISO Speed Noise Reduction.....	218
Dust Delete Data Acquisition.....	220
Multiple Exposures.....	224
HDR Mode.....	235
Focus Bracketing.....	240
Interval Timer Shooting.....	244
Shutter Mode.....	248
Releasing Shutter without Card.....	250

Image Stabilizer (IS Mode).....	251
Shooting with the Touch Shutter.....	254
Image Review.....	256
High-Speed Display.....	259
Metering Timer.....	261
Exposure Simulation.....	262
Shooting Information Display.....	263
Viewfinder Display Format.....	275
Display Performance.....	276
Metering Mode Selection.....	277
Manual Exposure Compensation.....	279
Exposure Lock (AE Lock).....	281
General Still Photo Shooting.....	283
Movie Recording.....	286
Tab Menu: Movie Recording.....	288
Movie Recording.....	292
Movie Recording Quality.....	308
Recording Cropped Movies.....	320
Sound Recording.....	321
Canon Log Settings.....	325
HDR Movie Recording.....	332
Time-Lapse Movies.....	334
Movie Self-Timer.....	348
Image Stabilizer (IS Mode).....	349
Shutter Button Function for Movies.....	353
Zebra Settings.....	355
Time Code.....	358
Other Menu Functions.....	365
General Movie Recording Precautions.....	375
AF/Drive.....	378
Tab Menu: AF (Still Photos).....	379
Tab Menu: AF (Movie Recording).....	383
AF Operation.....	386

Selecting the AF Method. . . . .	390
Continuous AF. . . . .	410
Movie Servo AF. . . . .	411
Touch & Drag AF Settings. . . . .	414
Manual Focus. . . . .	417
Servo AF Characteristics. . . . .	426
Customizing AF Functions. . . . .	437
Selecting the Drive Mode. . . . .	450
Using the Self-Timer. . . . .	453
Remote Control Shooting. . . . .	455
Playback. . . . .	460
Tab Menus: Playback. . . . .	462
Image Playback. . . . .	465
Magnified Image Display. . . . .	471
Index Display (Multiple-Image Display). . . . .	474
Voice Memo Recording and Playback. . . . .	477
Movie Playback. . . . .	483
Editing a Movie's First and Last Scenes. . . . .	486
4K/8K Movie Frame Grab. . . . .	489
Playback on a TV Set. . . . .	491
Protecting Images. . . . .	493
Erasing Images. . . . .	497
Rotating Still Photos. . . . .	504
Changing Movie Orientation Information. . . . .	506
Rating Images. . . . .	508
Copying Images. . . . .	516
Print Ordering (DPOF). . . . .	524
Photobook Set-up. . . . .	529
RAW Processing (RAW/DPRAW). . . . .	534
DPRAW Processing. . . . .	543
Resizing JPEG/HEIF Images. . . . .	550
Cropping JPEG/HEIF Images. . . . .	552
Converting HEIF to JPEG. . . . .	555

Slide Show	557
Setting Image Search Conditions	560
Browsing Images with the Main Dial	564
Switching the Main Dial and Quick Control Dial 2	566
Rate/Voice Memo Button Function	567
Customizing Playback Information Display	569
Displaying the Highlight Alert	573
AF Point Display	574
Playback Grid	575
Movie Play Count	576
HDMI HDR Output	578
<b>Wireless Features</b>	<b>579</b>
Tab Menus: Wireless Features	580
Wi-Fi/Bluetooth Connection	582
Connecting to a Smartphone	584
Connecting to a Computer via Wi-Fi	626
Sending Images to a Web Service	642
Image Transfer to FTP Servers	649
Wi-Fi Connection via Access Points	673
Connecting to a Wireless Remote Control	681
Reconnecting via Wi-Fi	686
Registering Multiple Connection Settings	688
Airplane Mode	690
Wi-Fi Settings	691
Bluetooth Settings	692
Nickname	693
GPS Device Settings	694
Changing or Deleting Connection Settings	699
Resetting Communication Settings	702
View Info Screen	703
Virtual Keyboard Operations	704
Responding to Error Messages	705
Wireless Communication Function Precautions	719

Security	720
Checking Network Settings	721
Wireless Communication Status	722
<b>Set-up</b>	<b>724</b>
Tab Menus: Set-up	725
Selecting Cards for Recording/Playback	729
Folder Settings	736
File Numbering	740
File Naming	745
Formatting	748
Auto Rotate	751
Adding Orientation Information to Movies	753
Date/Time/Zone	755
Language	759
Video System	760
Help	761
Beeps	764
Headphone Volume	765
Power Saving	766
Eco Mode	767
Screen/Viewfinder Display	768
Screen Brightness	770
Viewfinder Brightness	771
Screen and Viewfinder Color Tone	772
Fine-Tuning Viewfinder Color Tone	773
UI Magnification	774
HDMI Resolution	775
Touch Control	776
Multi-Function Lock	777
Shutter at Shutdown	778
Sensor Cleaning	779
Resetting the Camera	784
Custom Shooting Mode (C1-C3)	786

Battery Information. . . . .	789
Copyright Information. . . . .	797
Other Information. . . . .	800
<b>Custom Functions/My Menu. . . . .</b>	<b>801</b>
Tab Menus: Customization. . . . .	802
Custom Function Setting Items. . . . .	805
Tab Menus: My Menu. . . . .	832
Registering My Menu. . . . .	833
<b>Reference. . . . .</b>	<b>840</b>
Importing Images to a Computer. . . . .	841
Using a USB Power Adapter to Charge/Power the Camera. . . . .	845
Using a Battery Grip. . . . .	848
Troubleshooting Guide. . . . .	860
Error Codes. . . . .	877
System Map. . . . .	878
ISO Speed in Movie Recording. . . . .	881
Information Display. . . . .	882
EF Lenses Supporting 12 Shots/Sec. Continuous Shooting. . . . .	896
Specifications. . . . .	898
<b>Trademarks and Licensing. . . . .</b>	<b>917</b>



# Introduction

---

## Before starting to shoot, be sure to read the following

To avoid shooting problems and accidents, first read the [Safety Instructions](#) and [Handling Precautions](#). Also read this Advanced User Guide carefully to ensure that you use the camera correctly.

## Take some test shots, and understand about product liability

After shooting, play images back and check whether they have been properly recorded. If the camera or memory card is faulty and images cannot be recorded or transferred to a computer, Canon cannot be held liable for any loss or inconvenience caused.

## Copyrights

Copyright laws in some countries prohibit the unauthorized use of images recorded with the camera (or music/images with music transferred to the memory card) for purposes other than personal enjoyment.

Also be aware that certain public performances, exhibitions, etc. may prohibit photography even for private enjoyment.

### Connecting other devices

Use the included interface cable or a Canon cable when connecting the camera to a computer or other device. When connecting an interface cable, also use the included cable protector (🔒).

- [Package Contents](#)
- [Instruction Manuals](#)
- [Quick Start Guide](#)
- [About This Guide](#)
- [Compatible Cards](#)
- [Safety Instructions](#)
- [Handling Precautions](#)
- [Part Names](#)
- [Software](#)

## Package Contents

---

Before use, make sure the following items are included in the package. If anything is missing, contact your dealer.

---

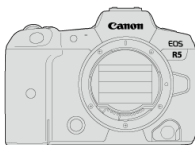

**Camera**  
(with body cap)



**Battery Pack LP-E6NH**  
(with protective cover)



**Battery Charger LC-E6/LC-E6E\***



**Strap**

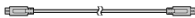

**Interface Cable IFC-100U**



**Cable Protector**

\* Battery Charger LC-E6 or LC-E6E is provided. (The LC-E6E comes with a power cord.)

- The camera does not come with a memory card (📁) or HDMI cable.
- If you purchased a Lens Kit, check that the lenses are included.
- Be careful not to lose any of these items.
- No software CD-ROM is included. Software (📁) can be downloaded from the Canon website.

 **Caution**

- When you need Lens Instruction Manuals, download them from the Canon website ()  
The Lens Instruction Manuals (PDF files) are for lenses sold individually. Note that when purchasing the Lens Kit, some of the accessories included with the lens may not match those listed in the Lens Instruction Manual.



The Instruction Manual included with the camera provides basic instructions for the camera and Wi-Fi functions.

- **Advanced User Guide**

Complete instructions are provided in this Advanced User Guide. For the latest Advanced User Guide, refer to the following website.  
<https://cam.start.canon/C003/>



- **Lens/Software Instruction Manual**

Download from the following website.  
<https://cam.start.canon/>



 **Note**

- Select [: **Manual/software URL**] to display the QR code on the camera screen.

## Quick Start Guide

---

### 1. Insert the battery (🔋).

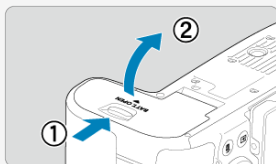

- Upon purchase, charge the battery to start using (🔋).

### 2. Insert the card (💳).

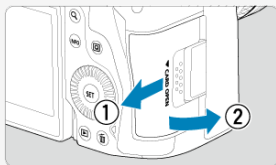

- You can insert two cards.

### 3. Attach the lens (🔍).

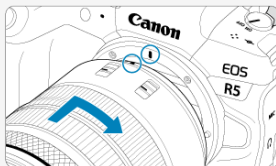

- Align the red mount index on the lens with the red mount index on the camera to attach the lens.

4. Set the lens's focus mode switch to < AF > (🔗).

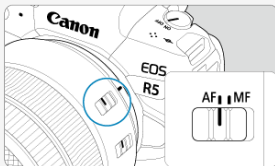

5. Set the power switch to < ON > (🔗).

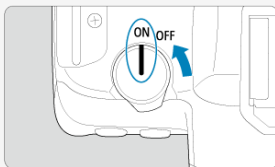

6. Flip out the screen (🔗).

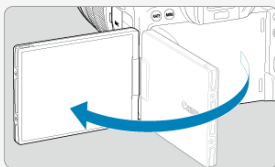

- When the date/time/zone setting screen is displayed, see [Date/Time/Zone](#).

## 7. Set the shooting mode to [A+] (🔗).

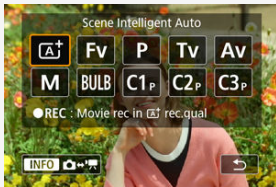

- Press the <MODE> button, then turn the <MODE DIAL> to select [A+].
- All the necessary camera settings will be set automatically.

## 8. Focus on the subject (🔗).

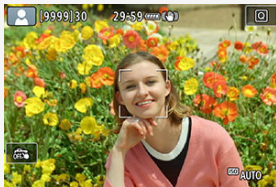

- An AF point [ ] appears over any face detected.
- Press the shutter button halfway, and the camera will focus on the subject.



## 9. Take the picture (🔗).

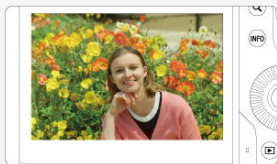

- Press the shutter button completely to take the picture.

## 10. Review the picture.



- The image just captured will be displayed for approx. 2 sec. on the screen.
- To display the image again, press the <  > button ().



## About This Guide







---

 [Icons in This Guide](#)







 [Basic Assumptions for Operational Instructions and Sample Photos](#)

### Icons in This Guide

---

	Indicates the Main dial.
	Indicates Quick control dial 1.
	Indicates Quick control dial 2.
	Indicates the Multi-controller.
	Indicates the lens control ring.
	Indicates the Set button.
	Indicates the duration (in * seconds) of the operation for the button you pressed, as timed after you release the button.

- In addition to the above, the icons and symbols used on the camera's buttons and displayed on the screen are also used in this guide when discussing relevant operations and functionality.

	☆ to the right of titles indicates functions only available in [Fv], [P], [Tv], [Av], [M], or [BULB] mode.
	Links to pages with related topics.
	Warning to prevent shooting problems.
	Supplemental information.
	Tips or advice for better shooting.
	Troubleshooting advice.

## Basic Assumptions for Operational Instructions and Sample Photos

---

- Before following any instructions, make sure the power switch is set to < ON > and the Multi-function lock feature is off (🔒, 🔒).
- It is assumed that all the menu settings and Custom Functions are set to their defaults.
- Illustrations in this guide show the camera with the RF24-105mm F4 L IS USM lens attached as an example.
- Sample photos displayed on the camera and used in this guide are for illustration only.
- In references to using EF or EF-S lenses, it is assumed that a mount adapter is used.

## Compatible Cards

---

The following cards can be used with the camera regardless of capacity. **If the card is new or was previously formatted (initialized) by another camera or computer, format it with this camera** (🔗).

- **CFexpress cards**

\* Type-B compatible

- **SD/SDHC/SDXC memory cards**

UHS-II and UHS-I cards supported.

---

### Cards That Can Record Movies

---

When recording movies, use a card with ample performance (fast enough writing and reading speeds) for the movie recording quality (🔗).

In this manual, "CFexpress card" refers specifically to CFexpress cards, "SD card" refers to SD/SDHC/SDXC memory cards collectively, and "card" refers to all memory cards in general.

**\*A card is not included.** Please purchase it separately.

## Safety Instructions

---

Be sure to read these instructions in order to operate the product safely.  
Follow these instructions to prevent injury or harm to the operator of the product or others.



**WARNING:** Denotes the risk of serious injury or death.

- Keep the product out of the reach of young children.  
A strap wrapped around a person's neck may result in strangulation.  
The parts or provided items of cameras or accessories are dangerous if swallowed. If swallowed, seek immediate medical assistance.  
The battery is dangerous if swallowed. If swallowed, seek immediate medical assistance.
  - Use only power sources specified in this instruction manual for use with the product.
  - Do not disassemble or modify the product.
  - Do not expose the product to strong shocks or vibration.
  - Do not touch any exposed internal parts.
  - Stop using the product in any case of unusual circumstances such as the presence of smoke or a strange smell.
  - Do not use organic solvents such as alcohol, benzene or paint thinner to clean the product.
  - Do not get the product wet. Do not insert foreign objects or liquids into the product.
  - Do not use the product where flammable gases may be present.
- This may cause electric shock, explosion or fire.
- Do not leave a lens or a camera/camcorder with a lens attached, exposed without the lens cap attached.

The lens may concentrate the light and cause fire.

- Do not touch the product connected to a power outlet during lightning storms.  
This may cause electric shock.
- Observe the following instructions when using a battery charger or AC adapter.
  - Use batteries/battery packs only with their specified product.
  - Do not heat batteries/battery packs or expose them to fire.
  - Do not charge batteries/battery packs using non-authorized battery chargers.
  - Do not expose the terminals to dirt or let them come into contact with metallic pins or other metal objects.
  - Do not use leaking batteries/battery packs.
  - When disposing of batteries/battery packs, insulate the terminals with tape or other means.
  - Do not touch the battery charger or AC adapter connected to a power outlet during lightning storms.

This may cause electric shock, explosion or fire.

If a battery/battery pack leaks and the material contacts your skin or clothing, flush the exposed area thoroughly with running water. In case of eye contact, flush thoroughly with copious amounts of clean running water and seek immediate medical assistance.

- Observe the following instructions when using a battery charger.
  - Periodically remove any dust buildup from the power plug and power outlet using a dry cloth.
  - Do not plug in or unplug the product with wet hands.
  - Do not use the product if the power plug is not fully inserted into the power outlet.
  - Do not expose the power plug and terminals to dirt or let them come into contact with metallic pins or other metal objects.
- Do not place heavy objects on the power cord. Do not damage, break or modify the power cord.
- Do not wrap the product in cloth or other materials when in use or shortly after use when the product is still warm in temperature.
- Do not unplug the product by pulling the power cord.
- Do not leave the product connected to a power source for long periods of time.
- Do not charge batteries/battery packs at temperatures outside the range of 5 - 40 °C (41 - 104 °F).

This may cause electric shock, explosion or fire.

- Do not allow the product to maintain contact with the same area of skin for extended periods of time during use.

This may result in low-temperature contact burns, including skin redness and blistering, even if the product does not feel hot. The use of a tripod or similar equipment is recommended when using the product in hot places and for people with circulation problems or less sensitive skin.

- Follow any indications to turn off the product in places where its use is forbidden.

Not doing so may cause other equipment to malfunction due to the effect of electromagnetic waves and even result in accidents.



## CAUTION:

Follow the cautions below. Otherwise physical injury or property damage may result.

- Do not fire the flash near the eyes.

It may hurt the eyes.

- Do not look at the screen or through the viewfinder for prolonged periods of time.

This may induce symptoms similar to motion sickness. In such a case, stop using the product immediately and rest for a while before resuming use.

- Flash emits high temperatures when fired. Keep fingers, any other part of your body, and objects away from the flash unit while taking pictures.

This may cause burns or malfunction of the flash.

- Do not leave the product in places exposed to extremely high or low temperatures.

The product may become extremely hot/cold and cause burns or injury when touched.

- Strap is intended for use on the body only. Hanging the strap with any product attached on a hook or other object may damage the product. Also, do not shake the product or expose the product to strong impacts.

- Do not apply strong pressure on the lens or allow an object to hit it.

This may cause injury or damage to the product.

- Only mount the product on a tripod that is sufficiently sturdy.

- Do not carry the product when it is mounted on a tripod.

This may cause injury or may result in an accident.

- Do not touch any parts inside the product.

This may cause injury.

- If any abnormal skin reaction or irritation occurs during or following the use of this product, refrain from further use and get medical advice/attention.

# Handling Precautions

---

## Camera care

- This camera is a precision instrument. Do not drop it or subject it to physical shock.
- The camera is not waterproof and cannot be used underwater.
- To maximize the camera's dust- and drip- resistance, keep the terminal cover, battery compartment cover, card slot cover, and all other covers firmly closed.
- This camera is designed to be dust- and drip- resistant, in order to help prevent sand, dust, dirt, or water that falls on it unexpectedly from getting inside, but it is impossible to prevent dirt, dust, water, or salt from getting inside at all. As far as possible, do not allow dirt, dust, water, or salt to get on the camera.
- If water gets on the camera, wipe it off with a dry and clean cloth. If dirt, dust, or salt gets on the camera, wipe it off with a clean, well-wrung wet cloth.
- Using the camera in dusty or dirty locations may lead to damage.
- Cleaning the camera after use is recommended. Allowing dirt, dust, water, or salt to remain on the camera may cause a malfunction.
- If you accidentally drop the camera into water or are concerned that moisture (water), dirt, dust, or salt may have gotten inside it, promptly consult the nearest Canon Service Center.
- Never leave the camera near anything having a strong magnetic field such as a magnet or electric motor. Also, avoid using or leaving the camera near anything emitting strong radio waves, such as a large antenna. Strong magnetic fields can cause camera malfunction or destroy image data.
- Do not leave the camera in excessive heat, such as in a car in direct sunlight. High temperatures can cause the camera to malfunction.
- The camera contains precision electronic circuitry. Never attempt to disassemble the camera yourself.
- Do not block shutter curtain operation with your finger or other objects. Doing so may cause a malfunction.
- Only use a commercially available blower to blow away dust on the lens, viewfinder, or other parts. Do not use cleaners that contain organic solvents to clean the camera body or lens. For stubborn dirt, take the camera to the nearest Canon Service Center.
- Do not touch the camera's electrical contacts with your fingers. This is to prevent the contacts from corroding. Corroded contacts can cause camera malfunction.
- If the camera is suddenly brought in from the cold into a warm room, condensation may form on the camera and internal parts. To prevent condensation, first put the camera in a sealed plastic bag and let it adjust to the warmer temperature before taking it out of the bag.
- If condensation forms on the camera, to avoid damage, do not use the camera or remove the lens, card, or battery. Turn the camera off and wait until the moisture has fully evaporated before resuming use. Even after the camera is completely dry, if it is still internally cold, do not remove the lens, card, or battery until the camera has adjusted to the ambient temperature.
- If the camera will not be used for an extended period, remove the battery and store the camera in a cool, dry, well-ventilated location. Even while the camera is in storage, press the shutter button a few times once in a while to check that the camera is still working.
- Avoid storing the camera where there are chemicals that result in rust and corrosion such as in a chemical lab.

- If the camera has not been used for an extended period, test all its functions before using it. If you have not used the camera for some time or if there is an important shoot such as a foreign trip coming up, have the camera checked by your nearest Canon Service Center or check the camera yourself and make sure it is working properly.
- The camera may become hot after repeated continuous shooting or still photo/movie shooting over an extended period. This is not a malfunction.
- If there is a bright light source inside or outside the image area, ghosting may occur.

## Screen, viewfinder, and LCD panel

- Although the screen and viewfinder are manufactured with very high precision technology with over 99.99% effective pixels, 0.01% or fewer of the pixels may be dead, and there may also be spots of black, red, or other colors. This is not a malfunction. They do not affect the images recorded.
- If the screen is left on for a prolonged period, screen burn-in may occur where you see remnants of what was displayed. However, this is only temporary and will disappear when the camera is left unused for a few days.
- The screen display may seem slightly slow in low temperatures or may look black in high temperatures. It will return to normal at room temperature.

## Cards

To protect the card and its recorded data, note the following:

- Do not drop, bend, or wet the card. Do not subject it to excessive force, physical shock, or vibration.
- Do not touch the card's electronic contacts with your fingers or anything metallic.
- Do not affix any stickers, etc. on the card.
- Do not store or use the card near anything that has a strong magnetic field, such as a television, speakers, or magnets. Also avoid places prone to having static electricity.
- Do not leave the card in direct sunlight or near a heat source.
- Store the card in a case.
- Do not store the card in hot, dusty, or humid locations.



## Lens

- After detaching the lens from the camera, put down the lens with the rear end up and attach the rear lens cap to avoid scratching the lens surface and electrical contacts (1).

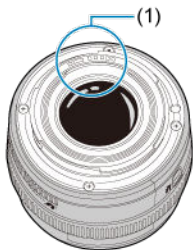

## Smudges on the image sensor

Besides dust entering the camera from outside, in rare cases, lubricant from the camera's internal parts may adhere to the front of the sensor. If smudges are visible on images, have the sensor cleaned by a nearest Canon Service Center.

## Battery

Tips for using the battery and charger

- Store in a cool, dry, well-ventilated location.
- When storing the battery for extended periods, charge it about once a year.
- When charging the battery, aim to charge it to approx. 50% instead of fully charging it (🔋).
- At room temperature (23°C/73°F), it takes approx. 60 min. to charge a depleted battery to about approx. 50%. Battery charging time varies greatly depending on ambient temperature.
- If the battery is not used for an extended period, the trace amount of current that continues to flow inside the battery when it is removed from the camera may eventually lead to over-discharge and prevent further use, even after charging.



## Part Names

---



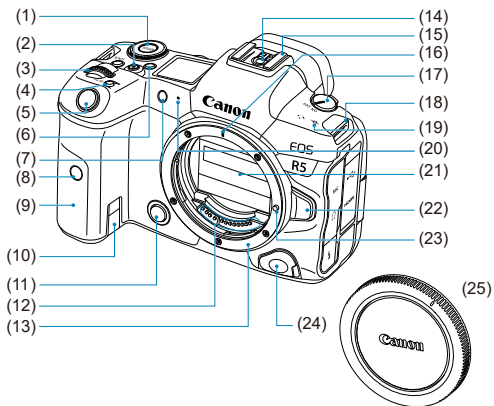



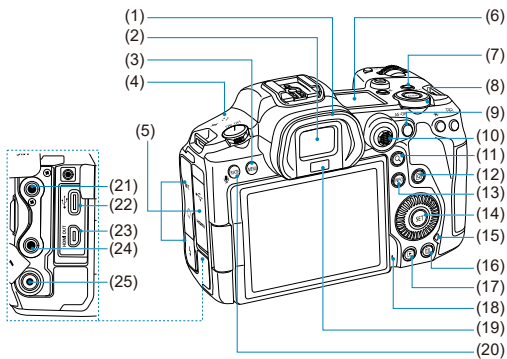

[Attaching the Strap](#)

[Using the Cable Protector](#)



(1)	< MODE > button
(2)	Movie shooting button
(3)	<  > Main dial
(4)	< M-Fn > Multi-function button
(5)	Shutter button
(6)	<  > LCD panel info switching/illumination button
(7)	Self-timer lamp/AF-assist beam
(8)	Remote control sensor
(9)	Grip (battery compartment)
(10)	DC coupler cord hole
(11)	Depth-of-field preview button
(12)	Contacts
(13)	Lens mount
(14)	Flash sync contacts
(15)	Hot shoe
(16)	RF lens mount index
(17)	Power switch
(18)	Strap mount
(19)	<  > Focal plane mark
(20)	Microphone
(21)	Shutter curtain/image sensor
(22)	Lens release button
(23)	Lens lock pin
(24)	Remote control terminal
(25)	Body cap



(1)	Eyecup
(2)	Viewfinder eyepiece
(3)	<MENU> Menu button
(4)	Speaker
(5)	Terminal cover
(6)	LCD panel
(7)	<LOCK> Multi-function lock button
(8)	<  > Quick control dial 2
(9)	<AF-ON> AF start button
(10)	<  > Multi-controller (can also be pressed straight in)
(11)	<Q> Magnify/Reduce button
(12)	<  > Quick Control button
(13)	<INFO> Info button
(14)	<  > Set button
(15)	Access lamp
(16)	<  > Erase button
(17)	<  > Playback button
(18)	Voice memo microphone
(19)	Viewfinder sensor
(20)	<RATE> Rating/Voice memo button
(21)	<MIC> External microphone IN terminal
(22)	<  > Digital terminal
(23)	<HDMI OUT> HDMI micro OUT terminal
(24)	<  > Headphone terminal
(25)	<  > PC terminal

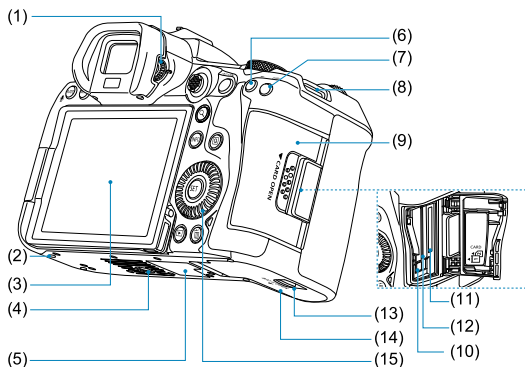

- |      |                                    |
|------|------------------------------------|
| (1)  | Dioptic adjustment knob            |
| (2)  | Accessory positioning hole         |
| (3)  | Screen                             |
| (4)  | Tripod socket                      |
| (5)  | Serial number (body number)        |
| (6)  | < * > AE lock button               |
| (7)  | < [AF] > AF point selection button |
| (8)  | Strap mount                        |
| (9)  | Card slot cover                    |
| (10) | Card eject button                  |
| (11) | Card slot 2                        |
| (12) | Card slot 1                        |
| (13) | Battery compartment cover lock     |
| (14) | Battery compartment cover          |
| (15) | < [Q] > Quick control dial 1       |

## LCD Panel Information Display



Information displayed varies depending on camera status. For icon details, see [Information Display](#).

## Viewfinder information display



Information displayed varies depending on camera status.

## Battery Charger LC-E6

Charger for Battery Pack LP-E6NH/LP-E6N/LP-E6 (🔌).

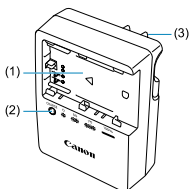

- (1) Battery slot
- (2) Charge lamp
- (3) Power plug



## Battery Charger LC-E6E

Charger for Battery Pack LP-E6NH/LP-E6N/LP-E6 (🔌).

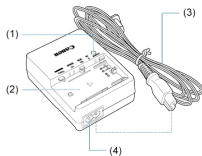

(1) Charge lamp

---

(2) Battery pack slot

---

(3) Power cord

---

(4) Power cord socket

---

## Attaching the Strap

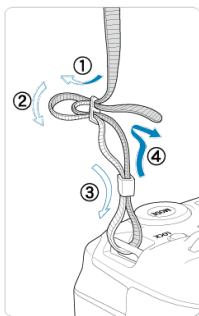

Pass the end of the strap through the strap mount from the bottom, then pass it through the strap buckle as shown. Pull the strap to take up any slack and make sure the strap will not loosen from the buckle.

## Using the Cable Protector

When connecting the camera to a computer, use the included interface cable or a Canon cable.

When connecting an interface cable, also use the included cable protector. Using the cable protector helps prevent accidental disconnection and terminal damage.

### Using the included interface cable and a commercially available HDMI cable

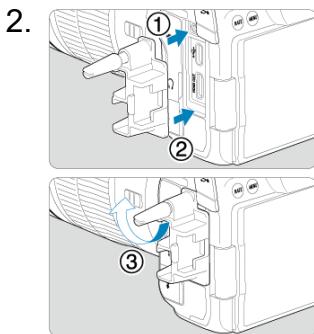
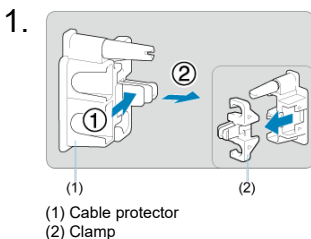

3.

Using a slim cable

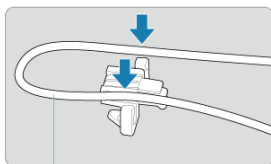

(3)

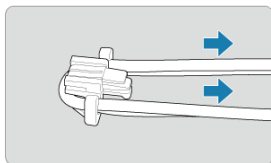
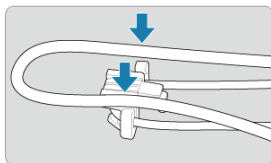
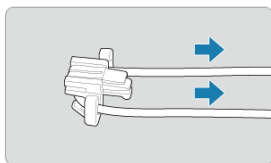

### Using a thick cable

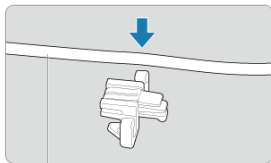

(3)

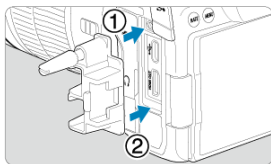

(3) Included interface cable

## 4.

### Using a slim cable

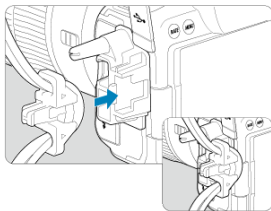

### Using a thick cable

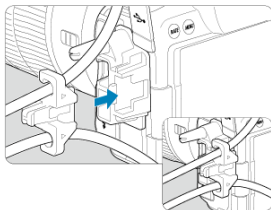

5.

**Using a slim cable**

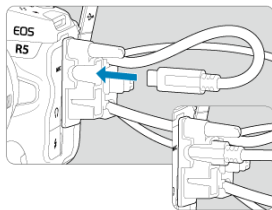

**Using a thick cable**

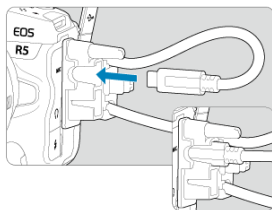

## 6.

### Using a slim cable

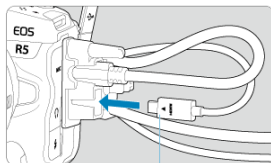

(4)

### Using a thick cable

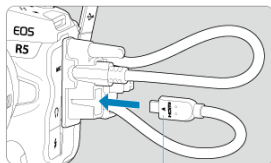

(4)

(4) HDMI cable (sold separately)

## Using an optional Canon interface cable

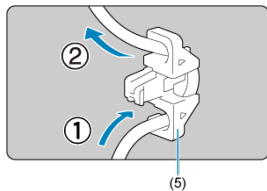

When using an optional Canon interface cable, pass the cable through the clamp (5) as shown before attaching the clamp to the cable protector.

### Caution

- Using the camera when the interface cable is connected without the cable protector may damage the digital terminal.
- Make sure the interface cable is securely connected to the digital terminal.

### Note

- Use a commercially available HDMI cable when connecting the camera to a television. Also consider using the cable protector when connecting an HDMI cable.



# Software

---

[✔ Software Overview](#)

[✔ Downloading and Installing EOS Software or Other Dedicated Software](#)

[✔ Downloading the Software Instruction Manual](#)

## Software Overview

---

This section summarizes software used with EOS cameras. Note that downloading and installing the software requires an internet connection. The software cannot be downloaded or installed in environments without an internet connection.

### EOS Utility

Enables you to transfer your captured still photos and movies from the camera to a connected computer, set various camera settings from the computer, and shoot remotely from the computer.

### Digital Photo Professional

Software recommended for users who shoot RAW images. Enables image viewing, editing, printing, and more.

### Picture Style Editor

Enables you to edit existing Picture Styles or create and save original Picture Style files. This software is for users who are familiar with image processing.

### GPS Log File Utility

Utility for converting GPS log files (.LOG) to KMZ format.

## Downloading and Installing EOS Software or Other Dedicated Software

---

Always install the latest version of the software.

Update any previous versions that are installed by overwriting them with the latest version.

### Caution

- Do not connect the camera to a computer before you install the software. The software will not be installed correctly.
- The software cannot be installed unless the computer is connected to the internet.
- Previous versions cannot display images from this camera correctly. Also, processing RAW images from this camera is not possible.

## 1. Download the software.

- Connect to the internet from a computer and access the following Canon website.

<https://cam.start.canon/>



- Select your country or region of residence and download the software.
- Depending on the software, you may need to enter the camera's serial number. The serial number is on the bottom of the camera.
- Decompress it on the computer.

- **For Windows**

Click the displayed installer file to start the installer.

- **For macOS**

A dmg file will be created and displayed. Follow the steps below to startup the installer.

1. Double-click the dmg file.

- A drive icon and installer file will appear on the desktop. If the installer file does not appear, double-click the drive icon to display it.

2. Double-click the installer file.

- The installer starts.

## 2. Follow the on-screen instructions to install the software.

## Downloading the Software Instruction Manual

---

Software Instruction Manuals (PDF files) can be downloaded from the Canon website to your computer, etc.

- **Software Instruction Manual download site**

<https://cam.start.canon/>



# Preparation and Basic Operations

---

This chapter describes preparatory steps before you start shooting and the basic camera operations.

- [Charging the Battery](#)
- [Inserting/Removing Batteries](#)
- [Inserting/Removing Cards](#)
- [Using the Screen](#)
- [Turning on the Power](#)
- [Attaching/Detaching RF Lenses](#)
- [Attaching/Detaching EF/EF-S Lenses](#)
- [Using the Viewfinder](#)
- [Basic Operations](#)
- [Menu Operations and Settings](#)
- [Quick Control](#)
- [Touch-Screen Operation](#)

## Charging the Battery

---

1. Detach the protective cover provided with the battery.

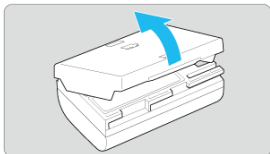

2. Fully insert the battery into the charger.

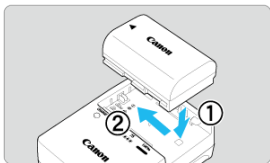

- Do the opposite to remove the battery.

### 3. Recharge the battery. For LC-E6

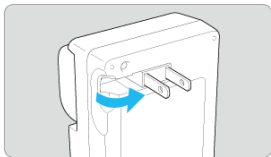

- As shown by the arrow, flip out the battery charger's prongs and insert the prongs into a power outlet.

#### For LC-E6E

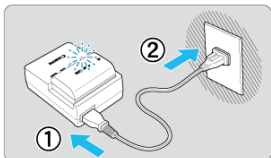

- Connect the power cord to the charger and insert the plug into a power outlet.
- Recharging starts automatically and the charge lamp blinks in orange.

Charge Level	Charge Lamp	
	Color	Display
0–49%	Orange	Blinks once per second
50–74%		Blinks twice per second
75% or higher		Blinks three times per second
Fully charged	Green	Turned on

- **Charging a depleted battery takes approx. 2 hr. and 30 min. at room temperature (23°C/73°F).** The time required to charge the battery will vary greatly depending on the ambient temperature and the battery's remaining capacity.
- For safety, charging in low temperatures (5–10°C/41–50°F) takes longer (up to approx. 4 hr.).

- **Upon purchase, the battery is not fully charged.**

Charge the battery before use.

- **Charge the battery on the day before or on the day it is to be used.**

Charged batteries gradually lose their charge, even when they are not used.

- **After charging the battery, remove it and disconnect the charger from the power outlet.**

- **You can attach the protective cover in a different orientation to indicate whether the battery is charged or not.**

If the battery is charged, attach the provided protective cover so that the battery-shaped hole <  > is aligned over the blue sticker on the battery. If the battery is exhausted, attach the protective cover in the opposite orientation.



- **When not using the camera, remove the battery.**

If the battery is left in the camera for a prolonged period, a small amount of power current will keep being released, resulting in excess discharge and shorter battery life. Store the battery with the protective cover attached. Storing the battery when it is fully charged may lower the battery performance.

- **The battery charger can also be used in foreign countries.**

The battery charger is compatible with a 100 V AC to 240 V AC 50/60 Hz power source. If necessary, attach a commercially available plug adapter for the respective country or region. To avoid damage, do not connect to portable voltage transformers.

- **If the battery becomes exhausted quickly even after having been fully charged, the battery has reached the end of its service life.**

Check the battery recharge performance () and purchase a new battery, as needed.

#### Caution

- After disconnecting the charger's power plug, do not touch the prongs for approx. 10 sec.
- If the battery's remaining capacity () is 94% or higher, the battery will not be charged.
- The provided charger cannot charge any battery other than Battery Pack LP-E6NH/LP-E6N/LP-E6.



# Inserting/Removing Batteries

---

 [Insertion](#)

 [Removal](#)

Insert a fully charged Battery Pack LP-E6NH (or LP-E6N/LP-E6) in the camera.

---

## Insertion

---

1. Slide the battery compartment cover lock and open the cover.

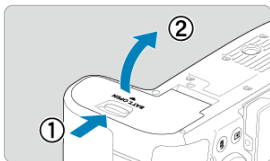

2. Insert the battery.

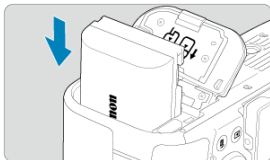

- Insert the end with the electrical contacts.
- Insert the battery until it locks in place.

### 3. Close the cover.



- Press the cover until it snaps shut.

#### Caution

- You cannot use batteries other than Battery Pack LP-E6NH/LP-E6N/LP-E6.

### 1. Open the cover and remove the battery.

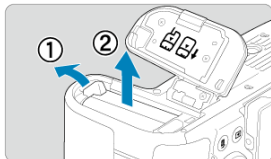

- Press the battery lock lever as shown by the arrow and remove the battery.
- To prevent short-circuits, always attach the included protective cover (🔒) to the battery.

## Inserting/Removing Cards

---

[✔ Insertion](#)

[✔ Formatting the Card](#)

[✔ Removal](#)

This camera accepts two cards. **Recording is possible as long as there is at least one card in the camera.**

With two cards inserted, you can select one card to record to, or you can record the same image to both cards at once (☑).

### ⚠ Caution

- **Make sure the SD card's write-protect switch (1) is set upward to enable writing and erasing.**

---

## Insertion

---

1. Slide the cover to open it.

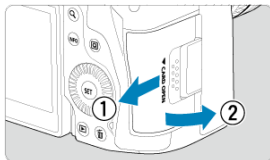

## 2. Insert the card.

### Card 1 (CFexpress card)

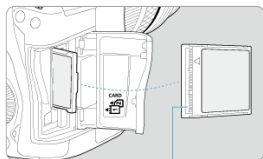

(2)

### Card 2 (SD card)

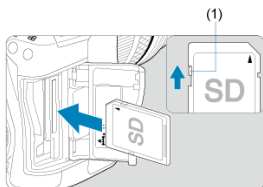

(1)

- The card in the rear card slot is [1] (CFexpress card), and the one in front of it is [2] (SD card).
- CFexpress card: With the card label facing you, insert the open side of the card (2) into the card slot. **Inserting cards the wrong way may damage the camera.**
- The gray card-eject button pops out.
- SD card: With the card label facing you, insert the card into the card slot until it clicks into place.

### 3. Close the cover.

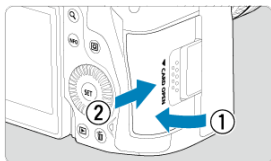

- Close the cover and slide it in the direction shown by the arrows until it snaps shut.

4. Set the power switch to <ON> (☑).

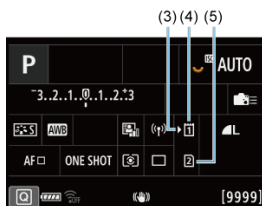
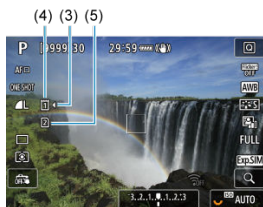

- (3) Card selection icon
- (4) Card 1 (CFexpress card)
- (5) Card 2 (SD card)

- Shooting screen (☑) or Quick Control screen (☑) accessed by pressing the <INFO> button shows which cards are loaded. **Cards labeled with [j] are selected for recording.**

## Formatting the Card

---

If the card is new or was previously formatted (initialized) by another camera or computer, format the card with this camera (🔗).



### 1. Open the cover.

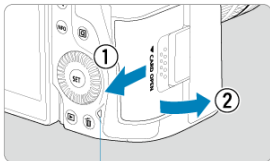

(1)

- Set the power switch to <OFF>.
- Check that the access lamp (1) is off, then open the cover.
- If [Saving...] is displayed on the screen, close the cover.

### 2. Remove the card.

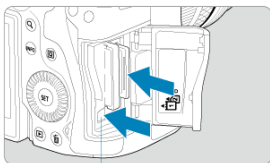



(2)

- CFexpress card: Press the card eject button (2) to eject the card.
- SD card: Gently press the card in, then release it to eject it.
- Pull the card straight out, then close the cover.



#### Caution

**Do not remove cards immediately after a red [ ] icon is displayed as you are shooting.** Cards may be hot, due to high internal camera temperature. Set the power switch to <OFF> and stop shooting for a while before removing cards. Removing hot cards immediately after shooting may cause you to drop and damage them. Be careful when removing cards.

#### Note

- The number of shots available varies depending on remaining card capacity and settings such as image quality and ISO speed.
- Setting [: **Release shutter without card**] to [**Disable**] will prevent you from forgetting to insert a card ().

#### Caution

- **When the access lamp is lit or blinking, it indicates that images are being written to, read from, or erased from the card, or data is being transferred. Do not open the card slot cover during this time. To avoid corrupting image data or damaging cards or the camera, never do any of the following while the access lamp is lit or blinking.**
  - **Removing the card.**
  - **Removing the battery.**
  - **Shaking or striking the camera.**
  - **Unplugging or plugging in a power cord**  
(when using optional household power outlet accessories).
- If the card already contains recorded images, the image number may not start from 0001 (.
- If a card-related error message is displayed on the screen, remove and reinsert the card. If the error persists, use a different card.  
If you can transfer images on the card to a computer, transfer all the images and then format the card with the camera (). The card may then return to normal.
- Do not touch the card's contacts with your fingers or metal objects. Do not expose the contacts to dust or water. If smudges adhere to the contacts, contact failure may result.
- Multimedia cards (MMC) cannot be used. (Card error will be displayed.)
- Use of UHS-II microSDHC/SDXC cards with a microSD to SD adapter is not recommended.  
When using UHS-II cards, use SDHC/SDXC cards.

## Using the Screen

---

You can change the direction and angle of the screen.

---

### 1. Flip out the screen.

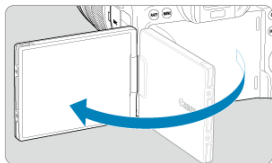

### 2. Rotate the screen.

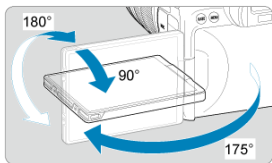

- When the screen is out, you can tilt it up or down or rotate it to face the subject.
- Indicated angles are only approximate.

### 3. Face it toward you.

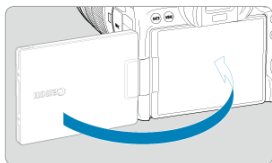

- Normally, use the camera with the screen facing you.

 **Caution**

- Avoid forcing the screen into position as you rotate it, which puts undue pressure on the hinge.
- When a cable is connected to a camera terminal, the rotation angle range of the flipped-out screen will be limited.

 **Note**

- Keep the screen closed and facing the camera body when the camera is not in use. You can protect the screen.
- A mirror image (right/left reversed) of subjects is displayed when the screen faces subjects in front of the camera.

## Turning on the Power

---

[Setting the Date, Time, and Time Zone](#)

[Changing the Interface Language](#)

[Automatic Sensor Cleaning](#)

[Battery Level Indicator](#)

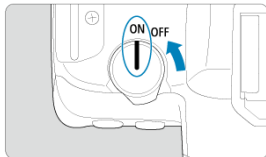

- **<ON>**

The camera turns on.

- **<OFF>**

The camera is turned off and does not function. Set the power switch to this position when not using the camera.

 **Note**

- If you set the power switch to **<OFF>** while an image is being recorded to the card, **[Saving...]** will be displayed and the power will turn off after the recording finishes.

## Setting the Date, Time, and Time Zone

---

If you turn on the camera and the date/time/zone setting screen appears, see [Date/Time/Zone](#) to set the date/time/zone.





## Changing the Interface Language

---

To change the interface language, see [Language](#).

## Automatic Sensor Cleaning

---

- Whenever the power switch is set to < **OFF** >, the sensor is cleaned automatically (which may make a faint sound). During the sensor cleaning, the screen will display []. To enable automatic sensor cleaning when the power switch is set to < **ON** > as well, you can set this in [: **Sensor cleaning**] ().
- If you repeatedly turn the power switch to < **ON** > or < **OFF** > within a short time period, the [] icon may not be displayed, but this does not indicate the camera is malfunctioning.

## Battery Level Indicator

When the power switch is set to < ON >, the battery level will be indicated.

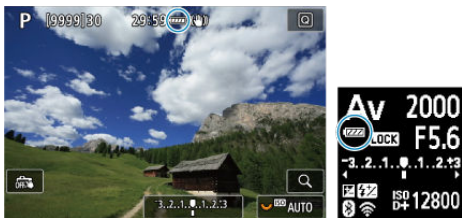

Display						
Level (%)	100–70	69–50	49–20	19–10	9–1	0

### Note

- Doing any of the following will exhaust the battery faster:
  - Pressing the shutter button halfway for a prolonged period.
  - Activating the AF frequently without taking a picture.
  - Using Image Stabilizer.
  - Using the Wi-Fi function or Bluetooth function.
- The number of available shots may decrease depending on the actual shooting conditions.
- Lens operations are powered by the camera's battery. Certain lenses may exhaust the battery faster than others.
- See [: **Battery info.**] to check the battery status ().
- In low ambient temperatures, shooting may not be possible even with a sufficient battery level.



## Attaching/Detaching RF Lenses

---

 [Attaching a Lens](#)

 [Detaching a Lens](#)

### Caution

- Do not look at the sun directly through any lens. Doing so may cause loss of vision.
- When attaching or detaching a lens, set the camera's power switch to <OFF>.
- If the front part (focusing ring) of the lens rotates during autofocusing, do not touch the rotating part.

### Tips for avoiding smudges and dust

- When changing lenses, do it quickly in a place with minimal dust.
- When storing the camera without a lens attached, be sure to attach the body cap to the camera.
- Remove smudges and dust on the body cap before attaching it.

## Attaching a Lens

### 1. Remove the caps.

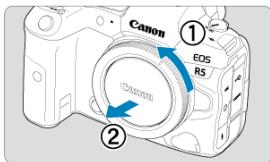
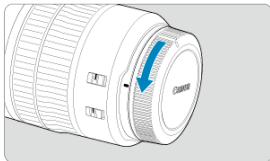

- Remove the rear lens cap and the body cap by turning them as shown by the arrows.

### 2. Attach the lens.

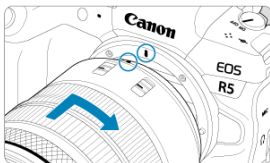

- Align the red mount index on the lens with the red mount index on the camera and turn the lens as shown by the arrow until it clicks in place.

3. Set the lens's focus mode switch to <AF>.

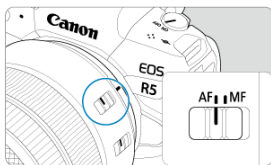

- <AF> stands for autofocus.
- <MF> stands for manual focus. Autofocus will not operate.



- For RF lenses without a focus mode switch, set to [AF] or [MF] in the camera menu, in [AF: Focus mode].

4. Remove the front lens cap.

## Detaching a Lens

While pressing the lens release button, turn the lens as shown by the arrow.

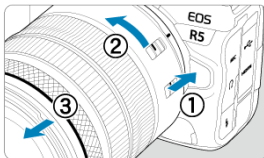

- Turn the lens until it stops, then detach it.
- Attach lens caps to the lens you removed.

# Attaching/Detaching EF/EF-S Lenses

---

 [Attaching a Lens](#)

 [Detaching a Lens](#)

All EF and EF-S lenses can be used by attaching an optional Mount Adapter EF-EOS R.  
**The camera cannot be used with EF-M lenses.**

---

## Attaching a Lens

---

### 1. Remove the caps.

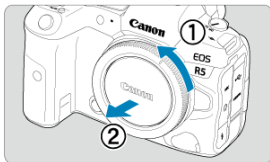
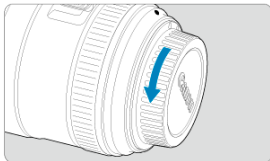

- Remove the rear lens cap and the body cap by turning them as shown by the arrows.

## 2. Attach the lens to the adapter.

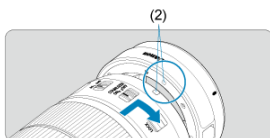
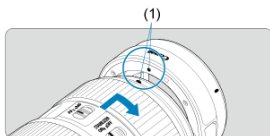

- Align the red or white mount index on the lens with the corresponding mount index on the adapter and turn the lens as shown by the arrow until it clicks into place.

(1) Red index

(2) White index

## 3. Attach the adapter to the camera.

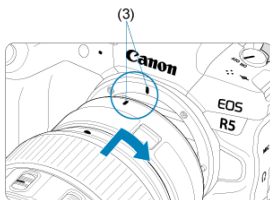

- Align the red mount indexes (3) on the adapter and camera and turn the lens as shown by the arrow until it clicks into place.

4. Set the lens's focus mode switch to <AF>.

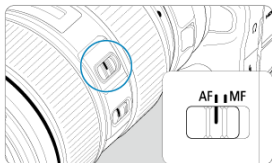

- <AF> stands for autofocus.
- <MF> stands for manual focus. Autofocus will not operate.

5. Remove the front lens cap.

## Detaching a Lens

1. While pressing the lens release button, turn the adapter as shown by the arrow.

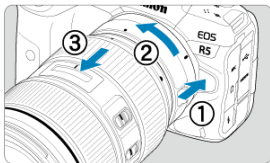

- Turn the lens until it stops, then detach it.

2. Detach the lens from the adapter.

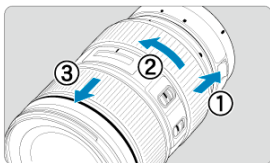

- Hold down the lens release lever on the adapter and turn the lens counterclockwise.
- Turn the lens until it stops, then detach it.
- Attach lens caps to the lens you removed.

### ⚠ Caution

- For lens precautions, see [Attaching/Detaching RF Lenses](#).



## Using the Viewfinder

---

Look through the viewfinder to activate it. You can also restrict display to either the screen or viewfinder (📷).

---

### Adjusting the Viewfinder

---

1. Turn the dioptic adjustment knob.

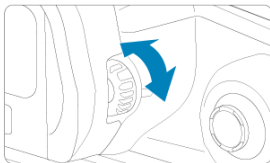

- Turn the knob left or right to make the viewfinder display look sharp.

#### ⚠ Caution

- The viewfinder and screen cannot be activated at the same time.
- At some aspect ratios, black bars are displayed on the top and bottom or left and right edges of the screen. These areas are not recorded.

## Basic Operations

---

- [Holding the Camera](#)
- [Shutter Button](#)
- [< !\[\]\(467d80e979964f7f8c752fb22248b5b7\_img.jpg\) > Main Dial](#)
- [< !\[\]\(b71552d33dbf62adf5e5199a70ee02bf\_img.jpg\) > Quick Control Dial 1](#)
- [< !\[\]\(03134b765d1473836ff001925b1b0550\_img.jpg\) > Quick Control Dial 2](#)
- [< !\[\]\(aed6947356668967079310026052edc0\_img.jpg\) > Multi-Controller](#)
- [< \*\*MODE\*\* > Button](#)
- [< \*\*M-Fn\*\* >: Multi-Function Button](#)
- [< \*\*AF-ON\*\* >: AF Start Button](#)
- [< \*\*LOCK\*\* >: Multi-Function Lock Button](#)
- [< !\[\]\(e61aeb0d9066d5d9e54d9b655f50da3d\_img.jpg\) > LCD Panel Info Switching/Illumination Button](#)
- [< !\[\]\(f7af41ce0777e13bda91fa715111c02a\_img.jpg\) > Control Ring](#)
- [< \*\*INFO\*\* >: Info Button](#)

## Holding the Camera

### ● Viewing the screen as you shoot

As you shoot, you can tilt the screen to adjust it. For details, see [Using the Screen](#).



- (1) Normal angle
- (2) Low angle
- (3) High angle

### ● Shooting through the viewfinder

To obtain sharp images, hold the camera still to minimize camera shake.

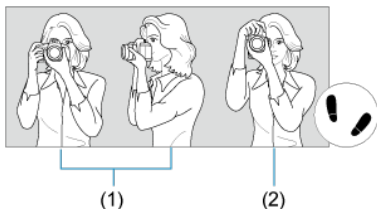

- (1) Horizontal shooting
- (2) Vertical shooting

1. With your right hand, hold the camera firmly by the camera grip.
2. With your left hand, support the lens from below.
3. Rest your right index finger lightly on the shutter button.
4. Rest your arms and elbows lightly against the front of your body.
5. To maintain a stable stance, place one foot slightly ahead of the other.
6. Hold the camera near your face and look through the viewfinder.

## Shutter Button

The shutter button has two steps. You can press the shutter button halfway. Then you can further press the shutter button completely.

### Pressing halfway

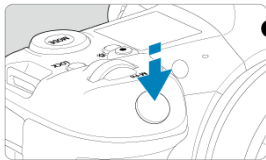

This activates autofocus and the automatic exposure system that sets the shutter speed and aperture value.

The exposure value (shutter speed and aperture value) is displayed on the screen, in the viewfinder, or on the LCD panel for 8 sec. (metering timer/Ⓢ).

### Pressing completely

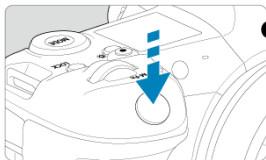

This releases the shutter and takes the picture.

### ● Preventing camera shake

Hand-held camera movement during the moment of exposure is called camera shake. It can cause blurred pictures. To prevent camera shake, note the following:

- Hold the camera still, as shown in [Holding the Camera](#).
- Press the shutter button halfway to autofocus, then slowly press the shutter button completely.



#### Note

- The camera will still pause before taking a picture if you press the shutter button completely without pressing it halfway first, or if you press the shutter button halfway and immediately press it completely.
- Even during menu display or image playback, you can return to shooting standby by pressing the shutter button halfway.

(1) After pressing a button, turn the <  > dial.

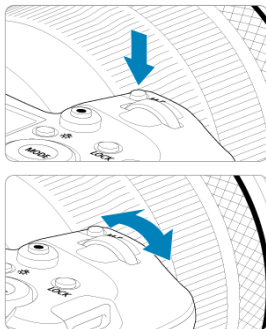



Press a button such as < MODE > or < M-Fn >, then turn the <  > dial.

If you press the shutter button halfway, the camera will go back to shooting standby.

- Used for operations such as setting the ISO speed, drive mode, AF operation, white balance, and flash exposure compensation.

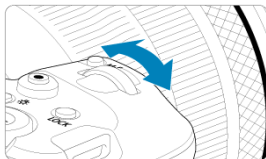
(2) Turn only the <  > dial.



Turn the <  > dial while looking at the screen, viewfinder, or LCD panel.

- Use this dial to set the shutter speed, aperture value, etc.

 **Note**

- The operations in (1) can be performed even when controls are locked with the Multi-function lock ().

## < > Quick Control Dial 1

(1) After pressing a button, turn the <  > dial.

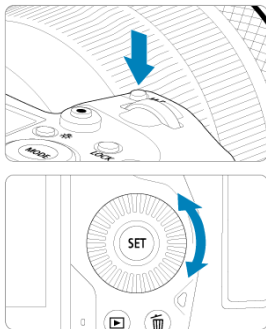



Press a button such as < MODE > or < M-Fn >, then turn the <  > dial.

If you press the shutter button halfway, the camera will go back to shooting standby.

- Used for operations such as selecting the ISO speed, drive mode, AF operation, white balance, and flash exposure compensation.

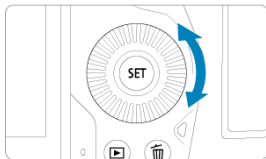
(2) Turn only the <  > dial.



Turn the <  > dial while looking at the screen, viewfinder, or LCD panel.

- Used for operations such as setting the exposure compensation amount and the aperture value setting for manual exposures.

### Note

- The operations in (1) can be performed even when controls are locked with the Multi-function lock ().

(1) After pressing a button, turn the <  > dial.

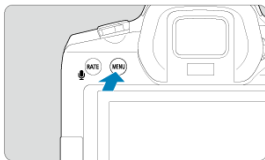

Press a button such as < MENU >, then turn the <  > dial.

If you press the shutter button halfway, the camera will go back to shooting standby.

- Used for operations such as switching between main tabs on the menu screen.

(2) Turn only the <  > dial.



Turn the <  > dial while looking at the screen, viewfinder, or LCD panel.

- Used for operations such as setting the ISO speed.

 **Note**

- The operations in (1) can be performed even when controls are locked with the Multi-function lock ().



## < \* > Multi-Controller

< \* > is an eight-direction key with center button. To use it, press lightly with the tip of your thumb.

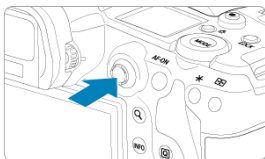
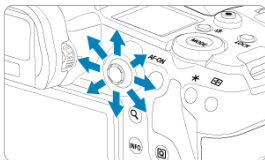

- Used for operations such as white balance correction, AF point/magnifying frame movement in still photo shooting or movie recording, magnifying frame movement during playback, or Quick Control settings.
- Can also be used to select or set menu items.

## <MODE> Button

You can set the shooting mode.



- Press the <MODE> button, then turn the <  > dial to select a shooting mode.
- To switch between shooting still photos and recording movies, press the <MODE> button and then the <INFO> button.

## <M-Fn>: Multi-Function Button

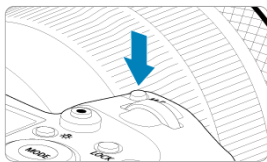

By pressing the <M-Fn> button and turning the <☀> dial, you can set the ISO speed (☑), drive mode (☑), AF operation (☑), white balance (☑), and flash exposure compensation (☑).

To select the AF area or AF method, press the <☐☐> button (☑), then press the <M-Fn> button.

## < AF-ON >: AF Start Button

Equivalent to pressing the shutter button halfway (except in [A+] mode).





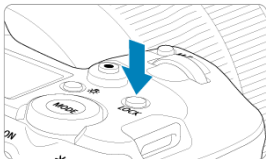

## <LOCK>: Multi-Function Lock Button

With [**Multi function lock**] configured (🔒), you can press the <LOCK> button to prevent settings from being changed by accidentally touching the Main dial, Quick Control dials, Multi-controller, control ring, or touch-screen panel. Press the <LOCK> button again to unlock the controls.

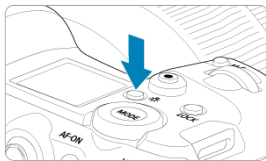

## < > LCD Panel Info Switching/Illumination Button





- Each press of the <  > button changes the information on the LCD panel.
- Illuminate the LCD panel by holding down the <  > button ().
- Access the [**Screen brightness**] setting by pressing the <  > button on the playback screen.

## < > Control Ring

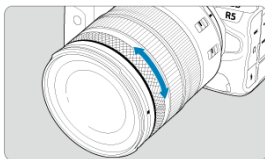
---



By default, exposure compensation can be set by turning the control ring of RF lenses or mount adapters while pressing the shutter button halfway in **[Fv]**, **[P]**, **[Tv]**, **[Av]**, or **[M]** mode. Otherwise, you can assign a different function to the control ring by customizing operations in [: **Customize dials**] ().

## <INFO>: Info Button

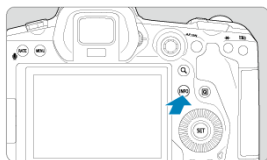

Each press of the <INFO> button changes the information shown. The following sample screens are for still photos.

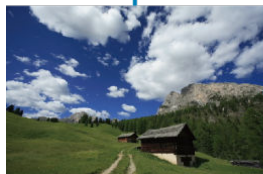



## Menu Operations and Settings

[Menu Screen in \[A+\] Mode](#)

[Menu Screen in \[Fv\]/\[P\]/\[Tv\]/\[Av\]/\[M\]/\[BULB\] Mode](#)

[Menu Setting Procedure](#)

[Dimmed Menu Items](#)

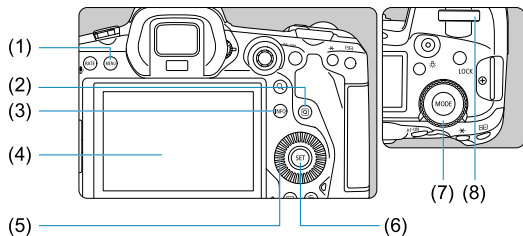

(1) <MENU> button

(2) <INFO> button

(3) <INFO> button

(4) Screen

(5) <QCD1> Quick control dial 1

(6) <SET> button

(7) <QCD2> Quick control dial 2

(8) <MDL> Main dial

## Menu Screen in [A+] Mode

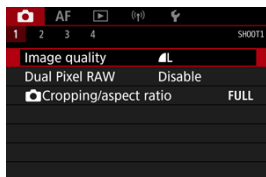

- In [A+] mode, some tabs and menu items are not displayed.

## Menu Screen in [Fv]/[P]/[Tv]/[Av]/[M]/[BULB] Mode

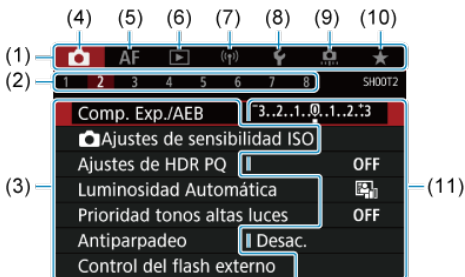

- 
- (1) Main tabs

---

  - (2) Secondary tabs

---

  - (3) Menu items

---

  - (4) : Shooting

---

  - (5) **AF**: Autofocus

---

  - (6) : Playback

---

  - (7) : Wireless features

---

  - (8) : Set-up

---

  - (9) : Custom Functions

---

  - (10) : My Menu

---

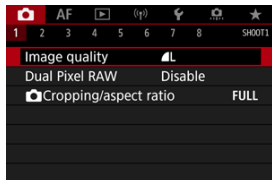

  - (11) Menu settings
-

### 1. Display the menu screen.



- Press the < MENU > button to display the menu screen.

### 2. Select a tab.

- Each time you turn the <  > dial, the main tab (group of functions) will switch. You can also switch tabs by pressing the <  > button.
- Turn the <  > dial to select a secondary tab.

### 3. Select an item.

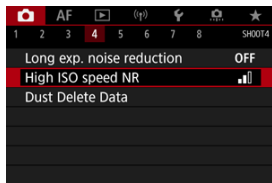

- Turn the <  > dial to select an item, then press <  >.

#### 4. Select an option.

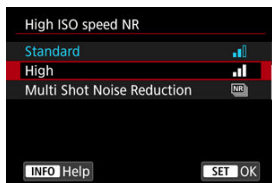

- Turn the <  > dial to select an option.
- The current setting is indicated in blue.

#### 5. Set an option.

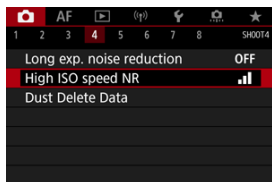

- Press <  > to set it.

#### 6. Exit the setting.

- Press the < **MENU** > button to return to shooting standby.

#### Note

- The description of menu functions hereafter assumes that you have pressed the < **MENU** > button to display the menu screen.
- Menu operations are also possible by tapping the menu screen or using <  >.
- To cancel the operation, press the < **MENU** > button.

## Dimmed Menu Items

Example: When Highlight tone priority has been set

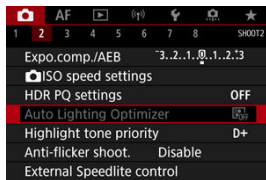

Dimmed menu items cannot be set. The menu item is dimmed if another function setting is overriding it.

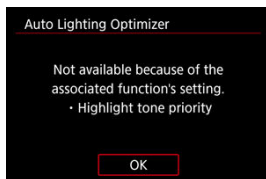

You can see the overriding function by selecting the dimmed menu item and pressing **< (SET) >**.

If you cancel the overriding function's setting, the dimmed menu item will become settable.

### Caution

- You may not be able to see the overriding function for certain dimmed menu items.

### Note

- You can reset menu functions to the default settings by selecting **[Basic settings]** in **[🔧: Reset camera]** (🔗).

## Quick Control

You can directly and intuitively select and set the settings displayed.

1. Press the **< Q >** button (10).



2. Select a setting item and set your preferred option.

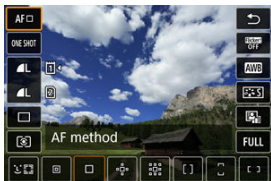

- To select an item, turn the **< 10 >** dial or press **< \* >** up or down.
- To adjust the setting, turn the **< 10 >** or **< 10 >** dial, or press **< \* >** left or right. Some items are set by pressing a button after this.



- Press **< \* >** vertically or horizontally to select an item on the screen shown above.
- To adjust the setting, turn the **< 10 >**, **< 10 >**, or **< 10 >** dial. Some items are set by pressing a button after this.

# Touch-Screen Operation

[Tapping](#)

[Dragging](#)



## Tapping

### Sample screen (Quick Control)



- Use your finger to tap (touch briefly and then remove your finger from) the screen.
- For example, when you tap [**Q**], the Quick Control screen appears. By tapping [**↶**], you can return to the preceding screen.

#### Note

- To have the camera beep for touch operations, set [**🔊: Beep**] to [**Enable**] ().
- Responsiveness to touch operations can be adjusted in [**🔊: Touch control**] ().



## Dragging

### Sample screen (Menu screen)



- Slide your finger while touching the screen.

## Shooting Mode

---

This chapter describes shooting modes.

- [A+: Fully Automatic Shooting \(Scene Intelligent Auto\)](#)
- [A+: Fully Automatic Techniques \(Scene Intelligent Auto\)](#)
- [Fv: Flexible-Priority AE](#)
- [P: Program AE](#)
- [Tv: Shutter-Priority AE](#)
- [Av: Aperture-Priority AE](#)
- [M: Manual Exposure](#)
- [BULB: Long \(Bulb\) Exposures](#)

## A+: Fully Automatic Shooting (Scene Intelligent Auto)

[A+] is a fully automatic mode. The camera analyzes the scene and sets the optimum settings automatically. It can also adjust focus automatically on either the still or moving subject by detecting the motion of the subject (AF).

1. Set the shooting mode to [A+].

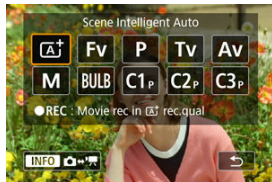

- Press the <MODE> button, then turn the <MODE DIAL> dial to select [A+].

2. Aim the camera at what you will shoot (the subject).



- An AF point may be displayed on the subject, under some shooting conditions.
- When an AF point is displayed on the screen, aim it over the subject.

### 3. Focus on the subject.

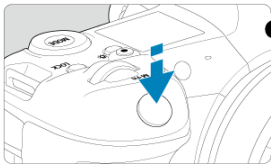

- Press the shutter button halfway to focus.
- You can also focus by tapping a person's face or another subject on the screen (Touch AF) when **[AF: Continuous AF]** is set to **[Disable]**.
- Under low light, the AF-assist beam (☼) is automatically activated if needed.
- For stationary subjects, the AF point is displayed in green when the subject is in focus, and the camera beeps. (One-Shot AF)
- For moving subjects, the AF point is displayed in blue and tracks subject movement. The camera does not beep. (Servo AF)

### 4. Take the picture.

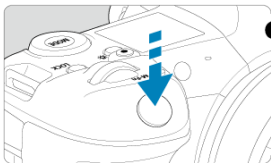



- Press the shutter button completely to take the picture.
- The image just captured will be displayed for approx. 2 sec. on the screen.

#### Caution



- Subject movement (whether subjects are still or moving) may not be detected correctly for some subject or shooting conditions.

 **Note**

- AF operation (One-Shot AF or Servo AF) is set automatically when you press the shutter button halfway. Note that AF operation cannot be switched during shooting.
-  mode makes the colors look more impressive in nature, outdoor, and sunset scenes. If you prefer other color tones, set the shooting mode to **[Fv]**, **[P]**, **[Tv]**, **[Av]**, or **[M]** and select a Picture Style other than  before shooting ().

## Minimizing blurred photos

---

- Use a sturdy tripod that can bear the weight of the shooting equipment. Mount the camera securely on the tripod.
- Using a remote switch (sold separately, ) or a wireless remote control (sold separately, ) is recommended.

## ? FAQ

---

- **Focusing is not possible (indicated by an orange AF point).**

Aim the AF point over an area with good contrast, then press the shutter button halfway (). If you are too close to the subject, move away and shoot again.
- **Multiple AF points are displayed simultaneously.**

If multiple AF points are displayed simultaneously, all of these positions are in focus. As long as one AF point is displayed on the subject, you can take the picture.
- **Pressing the shutter button halfway does not focus on the subject.**

If the lens's focus mode switch is set to < MF > (manual focus), set it to < AF > (autofocus).
- **The shutter speed display is blinking.**

Since it is too dark, taking the picture may result in a blurred subject due to camera shake. Using a tripod or a Canon EL/EX series Speedlite (sold separately, ) is recommended.
- **The bottom of pictures taken with flash is unnaturally dark.**

If a hood is attached to the lens, it may obstruct light from the flash. If the subject is close, detach the hood before taking the picture with flash.

## A+: Fully Automatic Techniques (Scene Intelligent Auto)

---

- [Recomposing the Shot](#)
- [Shooting Moving Subjects](#)
- [Scene Icons](#)

### Recomposing the Shot

---



Depending on the scene, positioning the subject toward the left or right to include a balanced background will result in a picture with better perspective. Pressing the shutter button halfway to focus on a still subject will lock the focus on that subject. Recompose the shot while keeping the shutter button pressed halfway, and then press the shutter button completely to take the picture. This is called "focus lock."

## Shooting Moving Subjects

---



After you press the shutter button halfway and a blue AF point appears, the camera detects subject movement and focuses using Servo AF. Keep the subject on the screen as you hold down the shutter button halfway, and at the decisive moment, press the shutter button completely.



## Scene Icons

---



The camera detects the scene type and sets everything automatically to suit the scene. The detected scene type is indicated in the upper left of the screen. For icon details, see [Scene Icons](#).

# Fv: Flexible-Priority AE

In this mode, you can set shutter speed, aperture value, and ISO speed manually or automatically and combine these settings with your choice of exposure compensation. Shooting in **[Fv]** mode, with control over each of these parameters, is equivalent to shooting in **[P]**, **[Tv]**, **[Av]**, or **[M]** mode.

\* **[Fv]** stands for Flexible value.

1. Set the shooting mode to **[Fv]**.

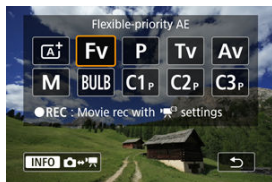

- Press the **<MODE>** button, then turn the **<☀>** dial to select **[Fv]**.

2. Set the shutter speed, aperture value, and ISO speed.



- Turn the **<☀>** dial to select an item to set. **[☀]** appears to the left of the selected item.
- Turn the **<☀>** dial to set the option.
- To reset the setting to **[AUTO]**, press the **<🗑>** button.

### 3. Set the amount of exposure compensation.



- Turn the < > dial and select the exposure level indicator. [ ] appears to the left of the exposure level indicator.
- Turn the < > dial to set the option.
- To reset the setting to  $\pm 0$ , press the < > button.

### Combinations of functions in [FV] mode

Shutter Speed	Aperture Value	ISO Speed	Exposure Compensation	Shooting Mode
[AUTO]	[AUTO]	[AUTO]	Available	Similar to [P]
		Manual selection		
Manual selection	[AUTO]	[AUTO]	Available	Similar to [Tv]
		Manual selection		
[AUTO]	Manual selection	[AUTO]	Available	Similar to [Av]
		Manual selection		
Manual selection	Manual selection	[AUTO]	Available	Similar to [M]
		Manual selection		

#### Caution

- Blinking of the values indicates a risk of underexposure or overexposure. Adjust the exposure until the value stops blinking.  
Slow synchro is not used under low light when you have set up [FV] mode to resemble [Av] or [P] mode, even when [Slow synchro] in [ : External Speedlite control ] is set to [1/250-30sec. auto] (or [1/200-30sec. auto]).



#### Note

- Values for shutter speed, aperture value, and ISO speed that are set to **[AUTO]** are underlined.
- You can set shutter speed, aperture value, and ISO speed to **[AUTO]** and exposure compensation amount to **[±0]** in step 2 or 3 by holding down the <  > button.

## P: Program AE

---

The camera automatically sets the shutter speed and aperture value to suit the subject's brightness.

\* [P] stands for Program.

\* AE stands for Auto Exposure.

---

### 1. Set the shooting mode to [P].



- Press the <MODE> button, then turn the <MODE> dial to select [P].

### 2. Focus on the subject.



- Aim the AF point over the subject and press the shutter button halfway.
- Once the subject is in focus, the AF point turns green (with One-Shot AF).
- The shutter speed and aperture value are set automatically.

### 3. Check the display.



- As long as the exposure value is not blinking, standard exposure will be obtained.

### 4. Take the picture.

- Compose the shot and press the shutter button completely.

#### ! Caution

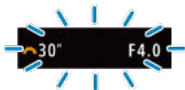

- If the "30"" shutter speed and the lowest aperture value blink, it indicates underexposure. Increase the ISO speed or use flash.



- If the "1/8000" shutter speed and the highest aperture value blink, it indicates overexposure. Lower the ISO speed or use an ND filter (sold separately) to reduce the amount of light entering the lens.

### Differences between [P] and [A+] modes

- [A+] mode limits available functions and sets the AF method, metering mode, and many other functions automatically to prevent bad shots. In contrast, [P] mode only sets the shutter speed and aperture value automatically, and you can freely set the AF method, metering mode, and other functions.

### Program shift

- In [P] mode, you can freely change the combination (program) of shutter speed and aperture value set automatically by the camera while maintaining the same exposure. This is called Program shift.
- With Program shift, you can press the shutter button halfway, then turn the <  > dial until the desired shutter speed or aperture value is displayed.
- Program shift will be canceled automatically when the metering timer ends (exposure setting display turns off).
- Program shift cannot be used with flash.

## Tv: Shutter-Priority AE

---

In this mode, you set the shutter speed and the camera automatically sets the aperture value to obtain the standard exposure matching the brightness of the subject. A faster shutter speed can freeze the action of a moving subject. A slower shutter speed can create a blurred effect, giving the impression of motion.

\* [Tv] stands for Time value.



Blurred motion  
(Slow speed: 1/30 sec.)



Frozen motion  
(Fast speed: 1/2000 sec.)

- 
1. Set the shooting mode to [Tv].



- Press the <MODE> button, then turn the <  > dial to select [Tv].



## 2. Set the desired shutter speed.



- Turn the <  > dial to set it.

## 3. Focus on the subject.

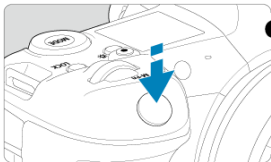

- Press the shutter button halfway.
- The aperture value is set automatically.

## 4. Check the display and shoot.



- As long as the aperture value is not blinking, the standard exposure will be obtained.

### Caution



- If the lowest aperture value blinks, it indicates underexposure. Turn the <  > dial to set a slower shutter speed until the aperture value stops blinking or set a higher ISO speed.



- If the highest aperture value blinks, it indicates overexposure. Turn the <  > dial to set a faster shutter speed until the aperture value stops blinking, or set a lower ISO speed.

 **Note****Shutter speed display**

- For example, “0”5” indicates 0.5 sec. and “15””, 15 sec.
- Shutter speeds from “8000” to “4” on the LCD panel indicate the denominator of the fractional shutter speed.

# Av: Aperture-Priority AE

---

## [Depth-of-Field Preview](#)

In this mode, you set the desired aperture value and the camera sets the shutter speed automatically to obtain the standard exposure matching the subject brightness. A higher  $f$ /number (smaller aperture hole) will make more of the foreground and background fall within acceptable focus. On the other hand, a lower  $f$ /number (larger aperture hole) will make less of the foreground and background fall within acceptable focus.

\* **[Av]** stands for Aperture value (aperture opening).



Blurred background  
(With a low aperture value:  $f/5.6$ )

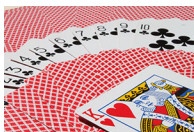

Sharp foreground and background  
(With a high aperture value:  $f/32$ )

---

## 1. Set the shooting mode to **[Av]**.



- Press the **<MODE>** button, then turn the  dial to select **[Av]**.

## 2. Set the desired aperture value.



- Turn the <img alt="Aperture dial icon" data-bbox="370 155 410 170"/> dial to set it.

## 3. Focus on the subject.

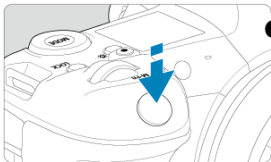

- Press the shutter button halfway.
- The shutter speed is set automatically.

## 4. Check the display and shoot.



- As long as the shutter speed is not blinking, the standard exposure will be obtained.

### Caution



- If the "30" shutter speed blinks, it indicates underexposure.  
Turn the <img alt="Aperture dial icon" data-bbox="235 755 275 770"/> dial to decrease the aperture value (open the aperture) until the shutter speed blinking stops or set a higher ISO speed.



- If the "1/8000" shutter speed blinks, it indicates overexposure.  
Turn the <img alt="Aperture dial icon" data-bbox="235 875 275 890"/> dial to increase aperture value (close the aperture) until the shutter speed blinking stops or set a lower ISO speed.



## Note

### Aperture value display

- The higher the value, the smaller the aperture opening will be. The aperture value displayed varies depending on the lens. If no lens is attached to the camera, “**F00**” will be displayed for the aperture.

## Depth-of-Field Preview

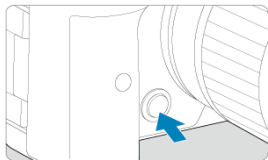

Press the depth-of-field preview button to stop down the lens to the current aperture value setting and check the area in focus (depth of field).



### Note

- The larger the aperture value, the wider the area in focus, from the foreground to the background.
- The depth-of-field effect is readily apparent on images as you change the aperture value and press the depth-of-field preview button.
- Exposure is locked (AE lock) as you hold down the depth-of-field preview button.

# M: Manual Exposure

## Exposure Compensation with ISO Auto

In this mode, you set both the shutter speed and aperture value as desired. To determine the exposure, refer to the exposure level indicator or use a commercially available exposure meter.

\* **[M]** stands for Manual.

### 1. Set the shooting mode to **[M]**.



- Press the <MODE> button, then turn the <MODE> dial to select **[M]**.

### 2. Set the ISO speed .

- Turn the <MODE> dial to set it.
- With ISO Auto, you can set exposure compensation .

### 3. Set the shutter speed and aperture value.



- To set the shutter speed, turn the <MODE> dial, and to set the aperture value, turn the <MODE> dial.

#### 4. Focus on the subject.



- Press the shutter button halfway.
- Check the exposure level mark [ ] to see how far the current exposure level is from the standard exposure level.

(1) Standard exposure index

(2) Exposure level mark

#### 5. Set the exposure and take the picture.



- Check the exposure level indicator and set the desired shutter speed and aperture value.

## Exposure Compensation with ISO Auto

If the ISO speed is set to **[AUTO]** for manual exposure shooting, you can set exposure compensation (☒) as follows:





- Tap the exposure level indicator
- [📷: Expo.comp./AEB]
- Quick Control screen
- Turn the control ring while pressing the shutter button halfway

### ! Caution

- Exposure may not be as expected when ISO Auto is set, because the ISO speed is adjusted to ensure standard exposure for your specified shutter speed and aperture value. In this case, set the exposure compensation.
- Exposure compensation is not applied in flash photography with ISO Auto, even if you have set an exposure compensation amount.



 **Note**

- In **[M]** mode with ISO Auto,  (evaluative metering), and : **AE lock meter. mode after focus** set to the default setting , holding down the shutter button halfway locks the ISO speed after the camera focuses with One-Shot AF.
- When ISO Auto is set, you can press the **< \* >** button to lock the ISO speed.
- If you press the **< \* >** button and recompose the shot, you can see the exposure level difference on the exposure level indicator compared to when the **< \* >** button was pressed.
- Any existing exposure compensation amount is maintained if you switch to **[M]** mode with ISO Auto after using exposure compensation in **[P]**, **[Tv]**, or **[Av]** mode .
- To coordinate exposure compensation in 1/2-stop increments with ISO speed set in 1/3-stop increments when : **Exposure level increments** is set to **[1/2-stop]** and used with ISO Auto, exposure compensation is further adjusted by adjusting shutter speed. However, the shutter speed displayed will not change.

# BULB: Long (Bulb) Exposures

---

## [Bulb Timer](#) ☆

In this mode, the shutter stays open as long as you hold down the shutter button completely, and closes when you let go of the shutter button. Use bulb exposures for night scenes, fireworks, astrophotography, and other subjects requiring long exposures.

---

### 1. Set the shooting mode to [BULB].



- Press the <MODE> button, then turn the < > dial to select [BULB].

### 2. Set the desired aperture value.

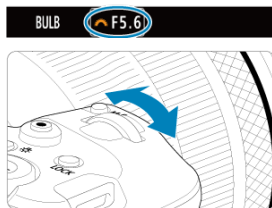

- Turn the < > dial to set it.



### 3. Take the picture.

- The exposure will continue for as long as you keep the shutter button pressed completely.
- Elapsed exposure time is displayed on the LCD panel.

#### Caution

- Do not point the camera toward an intense light source, such as the sun or an intense artificial light source. Doing so may damage the image sensor or the camera's internal components.
- Long bulb exposures produce more noise in the image than usual.
- ISO 400 is used when the camera is set to ISO Auto.
- When shooting bulb exposures with the self-timer instead of the bulb timer, keep pressing the shutter button completely (for the self-timer time and bulb exposure time).

#### Note

- You can reduce the noise generated during long exposures by using [: **Long exp. noise reduction**] ().
- Using a tripod and the bulb timer is recommended for bulb exposures.
- You can also shoot bulb exposures with Remote Switch TC-80N3 (sold separately, ).
- You can also use Remote Controller RC-6 or Wireless Remote Control BR-E1 (both sold separately) for bulb exposures. When you press the remote controller's release (transmit) button, the bulb exposure will start immediately or 2 sec. later. Press the button again to stop the bulb exposure.

## Bulb Timer



You can set the exposure time for bulb exposures in advance. This feature eliminates the need to keep holding down the shutter button during bulb exposures, which can reduce camera shake.

Note that the bulb timer can only be set and will only take effect in [**BULB**] (bulb exposure) mode.

1. Select [**☑**: Bulb timer].

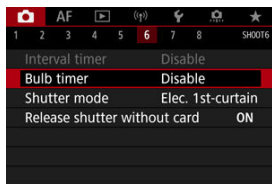

2. Select [**Enable**].

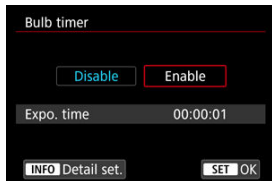

- Select [**Enable**], then press the < **INFO** > button.

3. Set the exposure time.

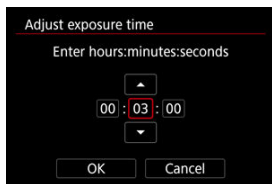

- Select an option (hours : minutes : seconds).
- Press < **SET** > to display [**↕**].
- Set a value, then press < **SET** >. (Returns to [**☐**].)

#### 4. Select [OK].

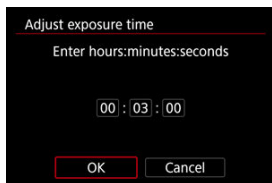

#### 5. Take the picture.

- After you press the shutter button completely, the bulb exposure continues for your specified time.
- [**TIMER**] and the exposure time are displayed on the LCD panel during bulb timer shooting.
- To clear the timer setting, select [**Disable**] in step 2.

#### ! Caution

- Bulb exposure stops if you press the shutter button completely and release it during the timer.
- Bulb exposure continues even after your specified exposure time if you keep pressing the shutter button completely (which overrides automatic stopping when your specified exposure time elapses).
- The bulb timer is cleared (and reverts to [**Disable**]) when you switch shooting modes.

## Shooting and Recording

---

This chapter describes shooting and recording and introduces menu settings on the shooting () tab.

- [Still Photo Shooting](#)
- [Movie Recording](#)

## Still Photo Shooting

---



To prepare for still photo shooting, press the <MODE> button, then press the <INFO> button to access the [Shooting mode] screen shown here.

☆ to the right of titles indicates functions only available in [Fv], [P], [Tv], [Av], [M], or [BULB] mode.

- [Tab Menus: Still Photo Shooting](#)
- [Image Quality](#)
- [Dual Pixel RAW](#)
- [Still Photo Cropping/Aspect Ratio](#)
- [Auto Exposure Bracketing \(AEB\) ☆](#)
- [ISO Speed Settings for Still Photos ☆](#)
- [HDR PQ Settings ☆](#)
- [Auto Lighting Optimizer ☆](#)
- [Highlight Tone Priority ☆](#)
- [Anti-Flicker Shooting ☆](#)
- [Shooting with Speedlites ☆](#)
- [Flash Function Settings ☆](#)
- [White Balance ☆](#)
- [White Balance Correction ☆](#)
- [Color Space ☆](#)
- [Picture Style Selection ☆](#)
- [Picture Style Customization ☆](#)
- [Picture Style Registration ☆](#)
- [Clarity ☆](#)
- [Lens Aberration Correction ☆](#)
- [Long Exposure Noise Reduction ☆](#)
- [High ISO Speed Noise Reduction ☆](#)
- [Dust Delete Data Acquisition ☆](#)
- [Multiple Exposures ☆](#)

- [HDR Mode](#) ☆
- [Focus Bracketing](#) ☆
- [Interval Timer Shooting](#)
- [Shutter Mode](#) ☆
- [Releasing Shutter without Card](#)
- [Image Stabilizer \(IS Mode\)](#)
- [Shooting with the Touch Shutter](#)
- [Image Review](#)
- [High-Speed Display](#) ☆
- [Metering Timer](#) ☆
- [Exposure Simulation](#) ☆
- [Shooting Information Display](#)
- [Viewfinder Display Format](#)
- [Display Performance](#)
- [Metering Mode Selection](#) ☆
- [Manual Exposure Compensation](#) ☆
- [Exposure Lock \(AE Lock\)](#) ☆
- [General Still Photo Shooting](#)



## Tab Menus: Still Photo Shooting

### ● Shooting 1

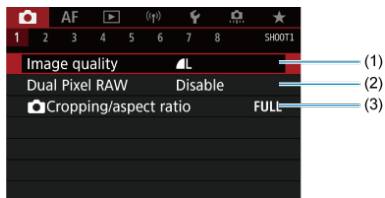

- (1) [Image quality](#)
- (2) [Dual Pixel RAW](#)
- (3) [Cropping/aspect ratio](#)

### ● Shooting 2

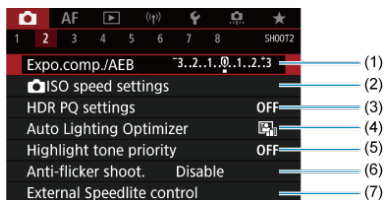

- (1) [Expo.comp./AEB](#) ☆
- (2) [ISO speed settings](#) ☆
- (3) [HDR PQ settings](#) ☆
- (4) [Auto Lighting Optimizer](#) ☆
- (5) [Highlight tone priority](#) ☆
- (6) [Anti-flicker shoot.](#) ☆
- (7) [External Speedlite control](#) ☆

### ● Shooting 3

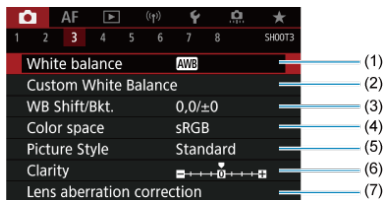

- (1) [White balance](#) ☆
- (2) [Custom White Balance](#) ☆
- (3) [WB Shift/Bkt.](#) ☆
- (4) [Color space](#) ☆
- (5) Picture Style
  - [Picture Style Selection](#) ☆
  - [Picture Style Customization](#) ☆
  - [Picture Style Registration](#) ☆
- (6) [Clarity](#) ☆
- (7) [Lens aberration correction](#) ☆

### ● Shooting 4

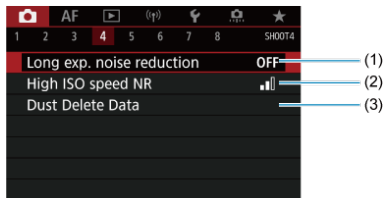

- (1) [Long exp. noise reduction](#) ☆
- (2) [High ISO speed NR](#) ☆
- (3) [Dust Delete Data](#) ☆

## ● Shooting 5



- (1) [Multiple exposure](#) ☆
- (2) [HDR Mode](#) ☆
- (3) [Focus bracketing](#) ☆

## ● Shooting 6

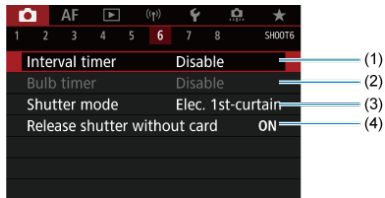

- (1) [Interval timer](#)
- (2) [Bulb timer](#) ☆
- (3) [Shutter mode](#) ☆
- (4) [Release shutter without card](#)

## ● Shooting 7

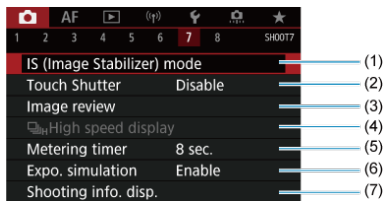

- (1) [IS \(Image Stabilizer\) mode](#)
- (2) [Touch Shutter](#)
- (3) [Image review](#)
- (4) [High speed display](#) ☆
- (5) [Metering timer](#) ☆
- (6) [Expo. simulation](#) ☆
- (7) [Shooting info. disp.](#)

## ● Shooting 8

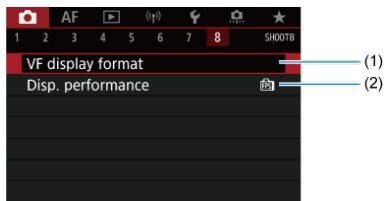

- (1) [VF display format](#)
- (2) [Disp. performance](#)

### ! Caution

- **[ IS (Image Stabilizer) mode]** is not displayed in [**Fv**], [**P**], [**Tv**], [**Av**], [**M**], or [**BULB**] shooting mode when an IS-equipped lens is attached.

In [**A+**] mode, the following screens are displayed.

## ● Shooting 1

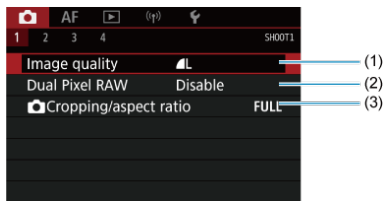

- (1) [Image quality](#)
- (2) [Dual Pixel RAW](#)
- (3) [Cropping/aspect ratio](#)

## ● Shooting 2

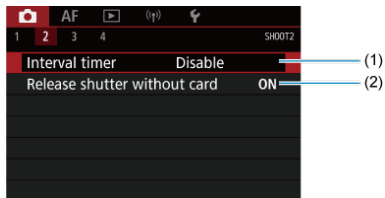

- (1) [Interval timer](#)
- (2) [Release shutter without card](#)

### ● Shooting 3

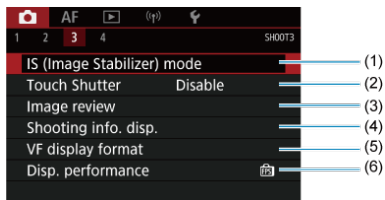

- (1) [IS \(Image Stabilizer\) mode](#)
- (2) [Touch Shutter](#)
- (3) [Image review](#)
- (4) [Shooting info. disp.](#)
- (5) [VF display format](#)
- (6) [Disp. performance](#)

### ● Shooting 4

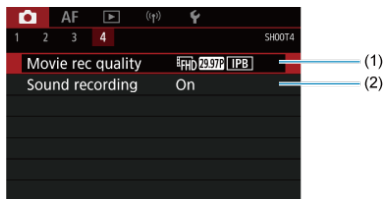

- (1) [Movie rec quality](#)
- (2) [Sound recording](#)









# Image Quality

---

[☑ RAW Images](#)

[☑ Guide to Image Quality Settings](#)



[☑ Maximum Burst for Continuous Shooting](#)

You can select the pixel count and the image quality. JPEG and HEIF image quality options include        , and RAW image quality options include **RAW**/**CRAW**.

---

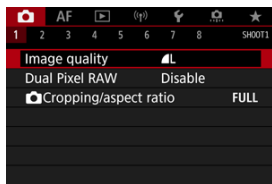
## 1. Select [: Image quality].





- The screen displayed varies depending on [ Record func.] settings in [ Record func+card/folder sel.].

## 2. Set the image quality.

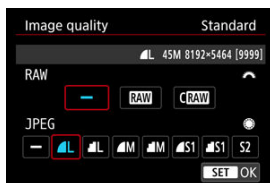



### Standard/Auto switch card/Record to multiple



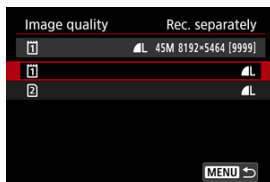

- For RAW images, turn the <  > dial, and for JPEG images, turn the <  > dial.
- Press <  > to set it.

### Record separately



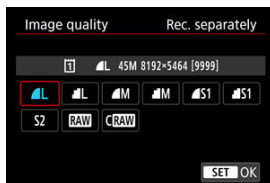

- When [ Record func.] in [: Record func+card/folder sel.] is set to [**Rec. separately**], turn the <  > dial to select [**1**] or [**2**], then press <  >. Note that recording separately to **RAW** and **CRAW** is not available for RAW images.



- Select an image quality on the screen displayed, then press <  >.





 **Note**

- HEIF can be specified when [HDR shooting **HDR PQ**] in [📷: HDR PQ settings] is set to [Enable]. You can convert these images to JPEG images after shooting (🔗).
-  is set if you set both RAW and JPEG/HEIF to [—].
- Two versions of each shot are recorded at your specified image quality when you have selected both RAW and JPEG/HEIF. Both images have the same file number but each has a different file extension, with .JPG for JPEG, .HIF for HEIF and .CR3 for RAW.
- **S2** is in  (Fine) quality.
- Meaning of image quality icons: **RAW** RAW, **CRRAW** Compact RAW, JPEG, HEIF, **L** Large, **M** Medium, **S** Small.

## RAW Images

RAW images are raw data from the image sensor that are recorded to the card digitally as **RAW** or **CRAW**, based on your selection. **CRAW** produces RAW images with smaller file sizes than **RAW**.

RAW images can be processed using [: **RAW processing (RAW/DPRAW)**] () and saved as JPEG or HEIF images. As the RAW image itself does not change, you can process the RAW image to create any number of JPEG or HEIF images with various processing conditions.

You can use Digital Photo Professional (EOS software) to process RAW images. You can make various adjustments to images depending upon how they will be used and can generate JPEG, HEIF, or other types of images reflecting the effects of those adjustments.

### Note

- To display RAW images on a computer, using Digital Photo Professional (EOS software, hereafter DPP) is recommended.
- Older versions of DPP Ver. 4.x do not support display, processing, editing, or other operations with RAW images captured by this camera. If a previous version of DPP Ver. 4.x is installed on your computer, obtain and install the latest version of DPP from the Canon website to update it () , which will overwrite the previous version. Similarly, DPP Ver. 3.x or earlier does not support display, processing, editing, or other operations with RAW images captured by this camera.
- Commercially available software may not be able to display RAW images captured by this camera. For compatibility information, contact the software manufacturer.

## Guide to Image Quality Settings

---

See [Still photo file size / Number of possible shots / Maximum burst for continuous shooting](#) for details on file size, number of shots available, maximum burst, and other estimated values.

## Maximum Burst for Continuous Shooting



The approximate maximum burst is displayed at the upper left of the shooting screen and lower right of the viewfinder.

### Note

- If the maximum burst is displayed as "99", it indicates that you can shoot 99 or more shots continuously. Fewer shots are available for a value of 98 or lower, and when [BUSY] is displayed on the screen, internal memory is full and shooting will stop temporarily. If you stop continuous shooting, the maximum burst will increase. After all captured images have been written to a card, you can once again shoot at the maximum burst listed in [Still photo file size / Number of possible shots / Maximum burst for continuous shooting](#).

# Dual Pixel RAW

---

Shooting **RAW** or **CRAW** images with this feature enabled produces special Dual Pixel RAW images containing dual pixel information from the image sensor. This is called Dual Pixel RAW shooting.

When processing these images on the camera, you can adjust the images by applying portrait relighting (👤) and background clarity (👤).

When processing the images in Digital Photo Professional software for EOS cameras, you can take advantage of the dual pixel data to fine-tune apparent resolution (using depth information), shift the camera viewpoint slightly, and reduce ghosting.

**Results will vary depending on shooting conditions, so before using this feature, refer to the Digital Photo Professional instruction manual for details on Dual Pixel RAW characteristics and image processing.**

---

1. Select [📷: Dual Pixel RAW].

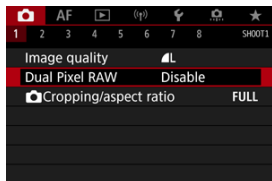

2. Select [Enable].

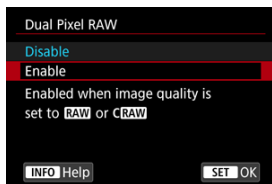

3. Set the image quality to **RAW** or **CRAW**.

- Set the image quality to **RAW**, **RAW**+JPEG, **RAW**+HEIF, **CRAW**, **CRAW**+JPEG, or **CRAW**+HEIF.

4. Take the picture.

- A RAW image containing dual pixel data (Dual Pixel RAW image) is captured.

## Caution

- Startup takes longer when the power switch is set to < ON > or the camera resumes operation from auto power off.
- Continuous shooting speed is slower when you shoot with Dual Pixel RAW (📷). Maximum burst is also lower.
- [📷] and [📷] drive modes are not available. Setting the mode to [📷] or [📷] has the effect of setting it to [📷].
- Noise may be slightly more noticeable in RAW, RAW+JPEG, or RAW+HEIF images.
- These features are not available: multiple exposures, HDR shooting, electronic shutter, and one-touch image quality setting.

## Note

### Amount and effect of Dual Pixel RAW correction

- Larger lens apertures increase the amount and effect of correction.
- The amount and effect of correction may not be sufficient with some lenses and in some shooting scenes.
- The amount and effect of correction varies depending on the camera orientation (vertical or horizontal).
- The amount and effect of correction may not be sufficient under some shooting conditions.
- See [Portrait Relighting](#) and [Background Clarity](#) for details on the amount and effect of correction for these options.

## Still Photo Cropping/Aspect Ratio

---

Normally with RF or EF lenses, images are captured at the sensor size of approx. 36.0×24.0mm in full-frame shooting, but in cropped shooting, you can isolate and magnify the center of the image approx. 1.6 (APS-C size) as if using a telephoto lens, or you can set an aspect ratio as needed before shooting. EF-S lenses capture a 3:2 area in the center, magnified approx. 1.6× (APS-C size).

---

1. Select []: Cropping/aspect ratio].

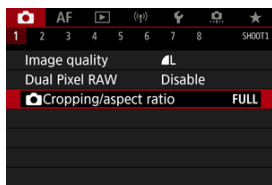

2. Select an option.

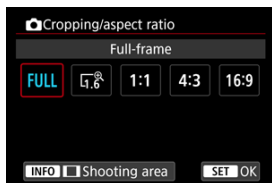

- Select [**Full-frame**], [**1.6x (crop)**], [**1:1 (aspect ratio)**], [**4:3 (aspect ratio)**], or [**16:9 (aspect ratio)**].
- With EF-S lenses, [**1.6x (crop)**] is set automatically, and no other option is available.
- To proceed without changing shooting area display, press < > and go to step 4.

### 3. Select how the shooting area is displayed.

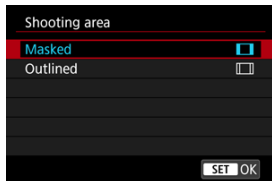

- On the screen in step 2, press the < INFO > button.
- Select the type of display, then press < SET >.

#### ! Caution

- image quality options are not available when [1.6x (crop)] is set, or with EF-S lenses.
- Shooting with [1.6x (crop)] and image quality set to produces images, respectively.
- Shooting with an EF-S lens when [1:1 (aspect ratio)], [4:3 (aspect ratio)], or [16:9 (aspect ratio)] is set automatically clears the setting and shoots with [1.6x (crop)] at a 3:2 aspect ratio.



## 4. Take the picture.

### Setting examples

When FULL is set



When  $\square_{1.6}$  is set or an EF-S lens is used



When  $1:1/\square$  is set





When  $4:3/\square$  is set



- When **[1.6x (crop)]** is set or an EF-S lens is used, an image magnified approx. 1.6× is displayed.
- When **[1:1 (aspect ratio)]**, **[4:3 (aspect ratio)]**, or **[16:9 (aspect ratio)]** is set, the image within the black masked or outlined area is captured.

#### Caution

- **Areas outside the cropped area are not recorded in RAW shooting when [1.6x (crop)] is set, or with EF-S lenses.**
- **[Shooting area]** has no effect on display when **[1.6x (crop)]** is set, or with EF-S lenses.
- **[: Add cropping information]** is only available when **[Full-frame]** is set.
- When external flash units are used, flash auto zoom (automatic adjustment of flash coverage) based on the **[:  Cropping/aspect ratio]** setting is not performed.

#### Note

- For details on pixel counts when cropping or an aspect ratio is set, see [Still photo pixel count](#).
- Nearly 100% field of view coverage is maintained vertically and horizontally when cropping or an aspect ratio is set.
- Aspect ratio information is added to RAW images when an aspect ratio is set, which are captured at full size. When the RAW images are played back, the image area used for shooting is indicated by lines. Note that only the shooting image area is shown in [Slide Show](#).

In exposure bracketing, three consecutive images are captured at different exposures within your specified range of up to  $\pm 3$  stops (in 1/3-stop increments) by automatically adjusting the shutter speed, aperture value, or ISO speed.

\* AEB stands for Auto Exposure Bracketing.

## 1. Select [📷: Expo.comp./AEB].

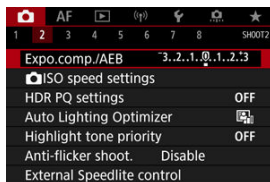

## 2. Set the AEB range.

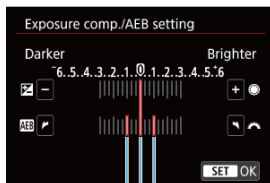

(1)

- Turn the <📷> dial to set the AEB range (1). By turning the <🔍> dial, you can set the exposure compensation amount.
- Press <SET> to set it.
- When you close the menu, the AEB range will be displayed on the screen.

### 3. Take the picture.

Standard exposure



Decreased exposure



Increased exposure



- Three bracketed shots are taken, according to the specified drive mode, in this sequence: Standard exposure, decreased exposure, and increased exposure.
- AEB will not be automatically canceled. To cancel AEB, follow step 2 to turn off the AEB range display.

#### ⚠ Caution

- Exposure compensation in AEB may be less effective with **[📷] Auto Lighting Optimizer** (🔘) set to an option other than **[Disable]**.

#### 📄 Note

- **[✳]** blinks in the lower left of the screen during AEB.
- If the drive mode is set to **[📷]**, press the shutter button three times for each shot. In **[📷]**, **[📷]**, or **[📷]** mode, holding down the shutter button completely captures three images, one after another, before the camera automatically stops shooting. When **[📷]** or **[📷]** is set, three consecutive shots are captured after a delay of 10 or 2 sec.
- You can set AEB in combination with exposure compensation.
- AEB is not available in flash photography or bulb exposures, or with Multi Shot Noise Reduction, HDR mode, focus bracketing, or when electronic shutter is set.
- AEB will be canceled automatically if you do any of the following: Setting the power switch to **< OFF >** or when the flash is fully charged.

[ISO Speed Range When Set Manually](#)

[ISO Speed Range Used with ISO Auto](#)

[Minimum Shutter Speed for ISO Auto](#)

Set the ISO speed (image sensor's sensitivity to light) to suit the ambient light level. In [A+] mode, ISO speed is set automatically.

For details on ISO speed in movie recording, see [ISO Speed in Movie Recording](#).

## 1. Set the ISO speed.







- With an image displayed on the screen, set by turning the <  > dial.
- ISO speed can be set within ISO 100–51200 in 1/3-stop increments.
- Select [AUTO] to set the ISO speed automatically.
- For details on the ISO Auto range, see [ISO speed \(recommended exposure index\) in still photo shooting](#).



## ISO speed guide

- Low ISO speeds reduce image noise but may increase the risk of camera/subject shake or reduce the area in focus (shallower depth of field), in some shooting conditions.
- High ISO speeds enable low-light shooting, a larger area in focus (deeper depth of field), and longer flash range but may increase image noise.

#### Note

- ISO speed can also be set in the ISO speed item by pressing the < M-Fn > button with an image displayed on the screen.
- Can also be set on the **[ISO speed]** screen in [:  **ISO speed settings**].
- To expand the available ISO speed range from L (equivalent to ISO 50) to H (equivalent to ISO 102400), adjust **[ISO speed range]** in [:  **ISO speed settings**] ().

#### Caution

- Image noise (dots of light or banding) and irregular colors may increase and apparent resolution may decrease at H (equivalent to ISO 102400), because this is an expanded ISO speed.
- Because L (equivalent to ISO 50) is an expanded ISO speed setting, the dynamic range will be somewhat narrower compared to the standard setting.
- Setting [: **Highlight tone priority**] to **[Enable]** or **[Enhanced]** () will prevent you from selecting L (equivalent to ISO 50), ISO 100/125/160, or H (equivalent to ISO 102400).
- When shooting with a high ISO speed, high temperature, long exposure, or multiple exposure, image noise (graininess, dots of light, banding, etc.), irregular colors, or color shift may become noticeable.
- When shooting in conditions that produce an extreme amount of noise, such as a combination of high ISO speed, high temperature, and long exposure, images may not be recorded properly.
- If you use a high ISO speed and flash to shoot a close subject, overexposure may result.

## ISO Speed Range When Set Manually

You can set the manual ISO speed setting range (minimum and maximum limits). You can set the minimum limit within L (equivalent to ISO 50) to ISO 51200, and the maximum limit within ISO 100 to H (equivalent to ISO 102400).

1. Select [: ISO speed settings].

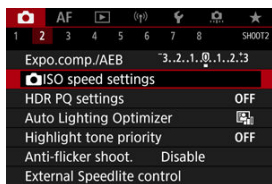

2. Select [ISO speed range].

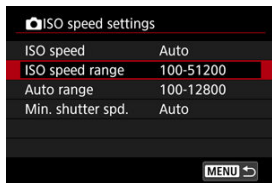

3. Set [Minimum].

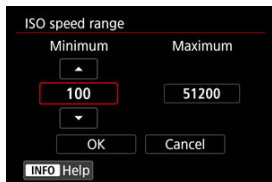

- Select the [Minimum] box, then press < >.
- Select the ISO speed, then press < >.

#### 4. Set [Maximum].

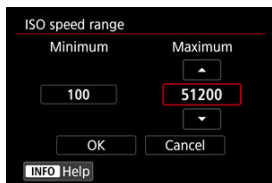

- Select the **[Maximum]** box, then press < **SET** >.
- Select the ISO speed, then press < **SET** >.

#### 5. Select [OK].



## ISO Speed Range Used with ISO Auto

You can set the automatic ISO speed range for ISO Auto within ISO 100–51200. The minimum can be set within ISO 100–25600 and the maximum within ISO 200–51200, in 1-stop increments.

### 1. Select [Auto range].

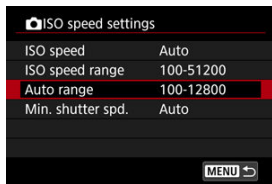

### 2. Set [Minimum].



- Select the **[Minimum]** box, then press < **SET** >.
- Select the ISO speed, then press < **SET** >.

### 3. Set [Maximum].

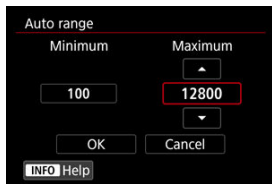

- Select the **[Maximum]** box, then press < **SET** >.
- Select the ISO speed, then press < **SET** >.

### 4. Select [OK].



#### Note

- The **[Minimum]** and **[Maximum]** settings will also function as the minimum and maximum speeds for ISO speed safety shift (**Q**).

## Minimum Shutter Speed for ISO Auto

To prevent shutter speeds from being set too low automatically, you can set the minimum shutter speed for ISO Auto.

This is effective in **[P]** or **[Av]** mode when shooting subjects in motion with a wide-angle lens, or when using a telephoto lens. It can also reduce camera shake and blurred subjects.

### 1. Select **[Min. shutter spd.]**.

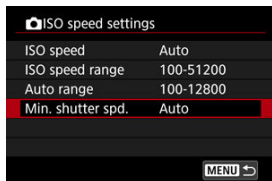

## 2. Set the desired minimum shutter speed.

### Auto

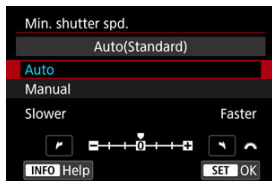

- If you select **[Auto]**, turn the < > dial to set the difference relative to standard speed (toward **Slower** or **Faster**), then press < >.

### Manual



- If you select **[Manual]**, turn the < > dial to select the shutter speed, then press < >.

### Caution

- If a correct exposure cannot be obtained with the maximum ISO speed limit set with **[Auto range]**, a shutter speed slower than the **[Min. shutter spd.]** will be set to obtain the standard exposure.
- This function will not be applied to flash photography.

### Note

- When **[Auto(Standard)]** is set, the minimum shutter speed will be the reciprocal of the lens focal length. A single step from **[Slower]** to **[Faster]** is equivalent to a single stop of the shutter speed.

PQ in HDR PQ refers to the gamma curve of the input signal for displaying HDR images. HDR PQ settings enable the camera to produce HDR images conforming to the PQ specification defined in ITU-R BT.2100 and SMPTE ST.2084. (Actual display depends on monitor performance.)

Shots are captured as HEIF or RAW images.

\* HDR stands for High Dynamic Range.

\* PQ stands for Perceptual Quantization.

## 1. Select [📷: HDR PQ settings].

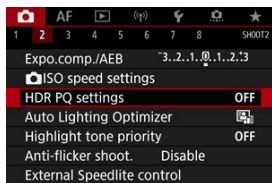

## 2. Set [HDR shooting HDR PQ].

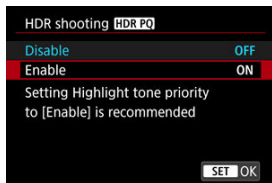

- Select [Enable].

### 3. Set [HDR assist disp: shooting].

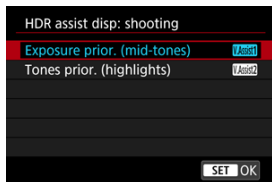

- On the screen, converted images are displayed that resemble how the images would look on an HDR display device.
- Select [**Exposure prior. (mid-tones)**] or [**Tones prior. (highlights)**].
- [**V.Assist1**] **Exposure prior. (mid-tones)**  
Provides reference display that emphasizes exposure of subjects (such as people) with intermediate brightness.
- [**V.Assist2**] **Tones prior. (highlights)**  
Provides reference display that emphasizes gradation of bright subjects (such as the sky).

#### 4. Set [HDR assist disp: playback].

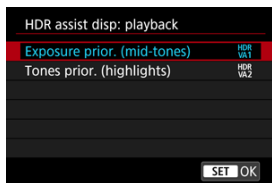

- Converted images are displayed on the screen for playback, giving an impression similar to how they would appear on an HDR display device.
- Select [**Exposure prior. (mid-tones)**] or [**Tones prior. (highlights)**].
- [**HDR<sub>VA1</sub>**] **Exposure prior. (mid-tones)**  
Provides reference display that emphasizes exposure of subjects (such as people) with intermediate brightness.
- [**HDR<sub>VA2</sub>**] **Tones prior. (highlights)**  
Provides reference display that emphasizes gradation of bright subjects (such as the sky).

#### 5. Set the image quality.

- For details, see [Image Quality](#).

##### Note

- Settings for [**HDR assist disp: shooting**] also apply to images displayed on the screen immediately after you shoot.

 **Caution**

- Expanded ISO speeds (L, H) are not available in HDR shooting.
- Some scenes may look different from how they appear on an HDR display device.
- Histograms of images captured with [HDR shooting HDR PQ] set to [Enable] are not based on images as converted for HDR assist display. Image areas shown in gray in the histogram roughly indicate signal values that are not used.
- [📷: Disp. performance] is not available when [HDR shooting HDR PQ] is set to [Enable]. It is set to [Smooth].
- For images captured with [HDR shooting HDR PQ] set to [Enable], before playback on an HDR display device, set [▶: HDMI HDR output] to [On] (🔗). Note that regardless of the [HDMI HDR output] setting, HDR images are used for Live View display on HDR display devices.



Brightness and contrast can be corrected automatically if shots look dark or contrast is too low or high.

In **[A+]** mode, **[Standard]** is set automatically.

## 1. Select **[📷: Auto Lighting Optimizer]**.

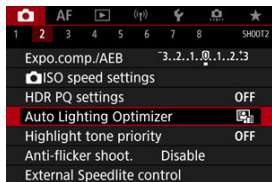

## 2. Set a correction option.

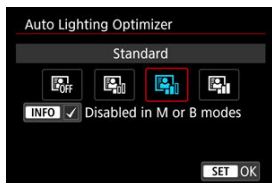

### ⚠ Caution

- Noise may increase and apparent resolution may change, under some shooting conditions.
- If the effect of Auto Lighting Optimizer is too strong and results are not at your preferred brightness, set to **[Low]** or **[Disable]**.
- If a setting other than **[Disable]** is set and you use exposure compensation or flash exposure compensation to darken the exposure, the image may still come out bright. If you want a darker exposure, set this function to **[Disable]**.



#### Note

- For **RAW** and **CRAW** images, face lighting can be adjusted in [**▶**]: **RAW processing (RAW/DPRAW)** ().
- To enable [**📷**: **Auto Lighting Optimizer**] to be set even in [**M**] and [**BULB**] modes, press the < **INFO** > button in step 2 to clear the checkmark [**✓**] for [**Disabled in M or B modes**].

You can reduce overexposed, clipped highlights.

## 1. Select [📷: Highlight tone priority].

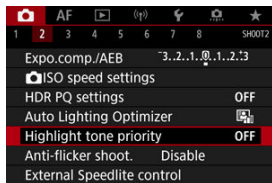

## 2. Set an option.

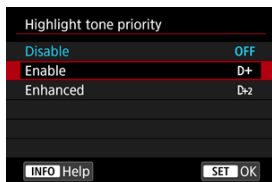

- **[Enable]**: Improves gradation in highlights. The gradation between the grays and highlights becomes smoother.
- **[Enhanced]**: Reduces overexposed highlights even more than **[Enable]**, under some shooting conditions.

### ⚠ Caution

- Noise may increase slightly.
- The available ISO range starts at ISO 200. Expanded ISO speeds cannot be set.
- With **[Enhanced]**, results in some scenes may not look as expected.

Uneven exposure and color may result if you shoot at fast shutter speeds under flickering light sources such as fluorescent lights, due to uneven vertical exposure. Anti-flicker shooting enables you to take pictures when exposure and colors are less affected by flickering.

1. Select [: Anti-flicker shoot.].

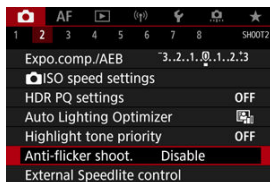

2. Select [Enable].

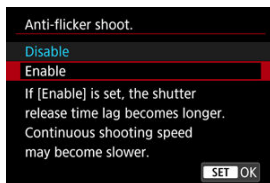

3. Take the picture.

## Caution

- When **[Enable]** is set and you shoot under a flickering light source, the shutter-release time lag may become longer. Also, the continuous shooting speed may become slower, and the shooting interval may become irregular.
- Flicker at a frequency other than 100 Hz or 120 Hz cannot be detected. Also, if the flickering frequency of the light source changes during continuous shooting, effects of the flicker cannot be reduced.
- In **[Fv]**, **[P]**, or **[Av]** mode, color tone of captured images may vary if the shutter speed changes during continuous shooting or if you take multiple shots of the same scene at different shutter speeds. To avoid inconsistent color tone, shoot in **[Fv]**, **[M]**, or **[Tv]** mode at a fixed shutter speed.
- Color tone of captured images may vary between **[Enable]** and **[Disable]**.
- Shutter speed, aperture value, and ISO speed may change when you start shooting with AE lock.
- If the subject is against a dark background or if there is a bright light in the image, flicker may not be properly detected.
- Flicker reduction may not be possible under special lighting.
- Depending on the light source, flicker may not be detected properly.
- Depending on the light sources or shooting conditions, the expected result may not be obtained even if you use this function.

## Note

- Taking test shots in advance is recommended.
- Detect flicker manually if the screen flickers (as when the light source changes) by pressing the **<[Q]>** button, selecting **[Anti-flicker shoot.]**, then pressing the **<[INFO]>** button.
- Flicker is not reduced in **[A+]** mode.
- Flicker reduction also works with flash photography. However, the expected result may not be obtained for wireless flash photography.



- ✔ [EL/EX Series Speedlites for EOS Cameras](#)
- ✔ [Canon Speedlites Other Than the EL/EX Series](#)
- ✔ [Non-Canon Flash Units](#)

## EL/EX Series Speedlites for EOS Cameras

Features of EL/EX series Speedlites (sold separately) can be used in flash photography with the camera.

For instructions, refer to the EL/EX series Speedlite's Instruction Manual.





### ● Flash exposure compensation

You can adjust flash output (flash exposure compensation). With an image displayed on the screen, press the < **M-Fn** > button, turn the <  > dial to select the flash exposure compensation item, then turn the <  > dial to set the flash exposure compensation amount. You can set the flash exposure compensation up to ±3 stops in 1/3-stop increments.

### ● FE lock

This enables you to obtain appropriate flash exposure for a specific part of the subject. Aim the viewfinder center over the subject, press the camera's <  > button, then compose the shot and take the picture.

#### Caution

- Setting [: **Auto Lighting Optimizer**] () to an option other than [**Disable**] may still cause images to look bright even if you set lower flash exposure compensation for darker images.
- In flash photography, set [: **Shutter mode**] to an option other than [**Electronic**] ()



#### Note

- The Speedlite will automatically fire an AF-assist beam as needed, if autofocus is difficult under low light.
- You can also set flash exposure compensation on the Quick Control screen (🔍) or in the [Flash function settings] setting of [📷: External Speedlite control] (🔍).
- The camera can turn on certain Speedlites automatically when the camera is turned on. For details, refer to the instruction manual of Speedlites that support this feature.

## Canon Speedlites Other Than the EL/EX Series

---

- With an EZ/E/EG/ML/TL series Speedlite set to A-TTL or TTL autoflash mode, the flash can be fired at full output only.  
Set the camera's shooting mode to **[M]** or **[Av]** and adjust the aperture value before shooting.
- When using a Speedlite that has manual flash mode, shoot in the manual flash mode.



## Non-Canon Flash Units

---

### ● Sync speed

The camera can synchronize with non-Canon compact flash units at up to 1/250 sec. (or up to 1/200 sec. with [📷: Shutter mode] set to [Mechanical]). With large studio flash units, the flash duration is longer than that of a compact flash unit and varies depending on the model. Before shooting, confirm that flash sync is performed correctly by taking some test shots at a sync speed of approx. 1/60 sec. to 1/30 sec.

#### ! Caution

- Using the camera with a dedicated flash unit or flash accessory for cameras of other manufacturers poses a risk of malfunction and even damage.
- Do not attach a high-voltage flash unit to the camera's hot shoe. It may not fire.

- [Flash Firing](#)
- [E-TTL Balance](#)
- [E-TTL II Flash Metering](#)
- [Continuous Flash Control](#)
- [Slow Synchro](#)
- [Flash Function Settings](#)
- [Flash Custom Function Settings](#)
- [Clearing Flash Function Settings/Clearing All Speedlite Custom Functions](#)

Functions of EL/EX Series Speedlites compatible with flash function settings can be set via a camera menu screen. Attach the Speedlite to the camera and turn on the Speedlite before setting the flash functions.

For details on the Speedlite's functions, refer to the Speedlite's Instruction Manual.

---

1. Select [: External Speedlite control].

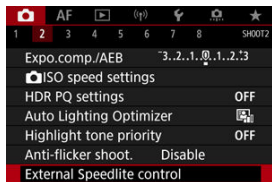

## 2. Select an option.

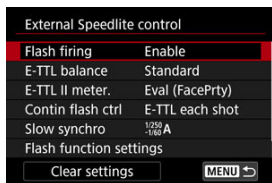

## Flash Firing

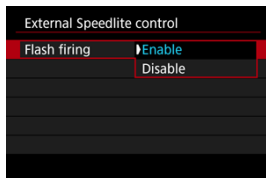

To enable flash photography, set to **[Enable]**. To enable only the AF-assist beam of the Speedlite, set to **[Disable]**.

## E-TTL Balance

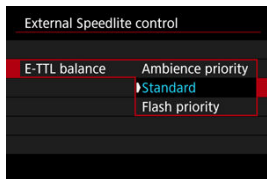

You can set your preferred appearance (balance) for flash shots. This setting enables you to adjust the ratio of ambient light to Speedlite light output.

- Set the balance to **[Ambience priority]** to lower the proportion of flash output and uses ambient light to produce lifelike shots with a natural mood. Especially useful when shooting dark scenes (indoors, for example). After switching to **[Av]** or **[P]** mode, consider setting **[Slow synchro]** in **[📷: External Speedlite control]** to **[1/250-30sec. auto]** (or **[1/200-30sec. auto]**) and using slow-sync shooting.
- Set the balance to **[Flash priority]** to make the flash the main source of light. Useful for reducing shadows on subjects and in the background from ambient light.

### ⚠ Caution

- Although **[Ambience priority]** is effective in dark scenes, there may be no difference from results with **[Standard]** in some scenes.

## E-TTL II Flash Metering

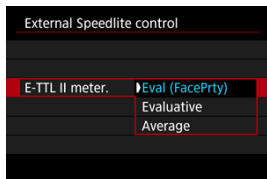

- Set to **[Eval (FacePrty)]** for flash metering suitable for shots of people. The continuous shooting speed for high-speed continuous shooting is slower than when **[Evaluative]** or **[Average]** is selected.
- Set to **[Evaluative]** for flash metering that emphasizes firing in continuous shooting.
- If **[Average]** is set, the flash exposure will be averaged for the entire metered scene.

### Note

- Depending on the scene, flash exposure compensation may be necessary.

### Caution

- Even when **[Eval (FacePrty)]** is set, some subjects and shooting conditions may prevent you from obtaining the expected result.

## Continuous Flash Control

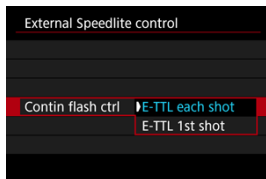

Set to **[E-TTL each shot]** to perform flash metering for each shot. Set to **[E-TTL 1st shot]** to perform flash metering for only the first shot before continuous shooting. The flash output level for the first shot is applied to all subsequent shots. Useful when prioritizing continuous shooting speed without recomposing shots.

### ! Caution

- Any subject movement in continuous shooting may cause exposure problems.

## Slow Synchro

You can set the flash-sync speed for flash photography in **[Av]** or **[P]** mode. Note that the maximum flash synchronization speed varies depending on the **[Shutter mode]** setting. It is 1/250 sec. when set to **[Elec. 1st-curtain]** and 1/200 sec. when set to **[Mechanical]**.

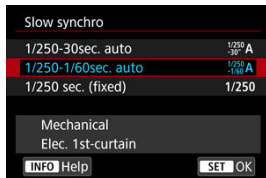

- $\frac{1}{250}$ <sub>-30</sub> A: **1/250-30sec. auto** ( $\frac{1}{200}$ <sub>-30</sub> A: **1/200-30sec. auto**)

The shutter speed is set automatically within a range of 1/250 (or 1/200) sec. to 30 sec. to suit the brightness. High-speed sync is also possible.

- $\frac{1}{250}$ <sub>-1/60</sub> A: **1/250-1/60sec. auto** ( $\frac{1}{200}$ <sub>-1/60</sub> A: **1/200-1/60sec. auto**)

Prevents a slow shutter speed from being set automatically in low-light conditions. It is effective for preventing subject blur and camera shake. Light from the flash provides standard exposure for subjects, but note that backgrounds may be dark.

- **1/250: 1/250 sec. (fixed)** (**1/200: 1/200 sec. (fixed)**)

The shutter speed is fixed at 1/250 sec. (or 1/200 sec.), which is more effective in preventing subject blur and camera shake than with **[1/250-1/60sec. auto]** (or **[1/200-1/60sec. auto]**). Note that under low light, backgrounds will be darker than with **[1/250-1/60sec. auto]** (or **[1/200-1/60sec. auto]**).

### ! Caution

- High-speed sync is not available in **[Av]** or **[P]** mode when set to **[1/250 sec. (fixed)]** or **[1/200 sec. (fixed)]**.

## Flash Function Settings

The information displayed on the screen, position of display, and available options vary depending on the Speedlite model, its Custom Function settings, the flash mode, and other factors. For details on the Speedlite's functions, refer to the Speedlite's Instruction Manual.

### Sample display

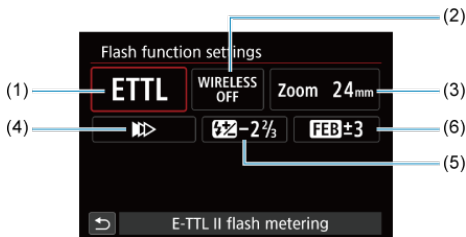

- |     |   |
|-----|---|
| (1) | Flash mode  |
| (2) | Wireless functions/<br>Firing ratio control (RATIO) |
| (3) | Flash zoom (flash coverage)                         |
| (4) | Shutter synchronization                             |
| (5) | Flash exposure compensation                         |
| (6) | Flash exposure bracketing                           |

### Caution

- Functions are limited when using EX series Speedlites that are not compatible with flash function settings.



## Flash mode

You can select the flash mode to suit your desired flash photography.

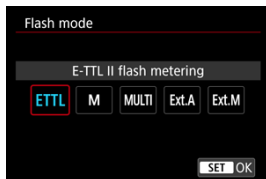

- **[E-TTL II flash metering]** is the standard mode of EL/EX series Speedlites for automatic flash photography.
- **[Manual flash]** is for setting the Speedlite's **[Flash output level]** yourself.
- **[CSP]** (Continuous shooting priority mode) is available when using a compatible Speedlite. This mode automatically reduces flash output by one stop and increases ISO speed by one stop. Useful in continuous shooting, and helps conserve flash battery power.
- Regarding other flash modes, refer to the Instruction Manual of a Speedlite compatible with the respective flash mode.

### Caution

- Adjust exposure compensation (☺) as needed in case of overexposure from flash photography with **[CSP]** in **[Fv]**, **[Tv]**, or **[M]** mode.

### Note

- With **[CSP]**, ISO speed is automatically set to **[Auto]**.

## Wireless functions



You can use radio or optical wireless transmission to shoot with wireless multiple-flash lighting.

For details on wireless flash, refer to the Instruction Manual of a Speedlite compatible with wireless flash photography.

## Firing ratio control (RATIO)

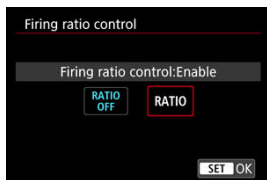

With a macro flash, you can set the firing ratio control.

For details on firing ratio control, refer to the Instruction Manual of the macro flash.

## Flash zoom (flash coverage)

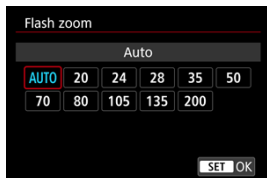

With Speedlites having a zooming flash head, you can set the flash coverage.

## Shutter synchronization

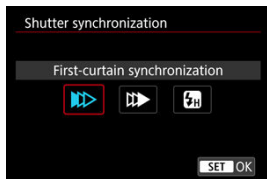

Normally, set this to [**First-curtain synchronization**] so that the flash fires immediately after the shooting starts.

Set to [**Second-curtain synchronization**] and use low shutter speeds for natural-looking shots of subject motion trails, such as car headlights.

Set to [**High-speed synchronization**] for flash photography at higher shutter speeds than the maximum flash sync shutter speed. This is effective when shooting with an open aperture in [**Av**] mode to blur the background behind subjects outdoors in daylight, for example.

### Caution

- When using second-curtain synchronization, set the shutter speed to 1/60 sec. or slower. If the shutter speed is 1/80 sec. or faster, first-curtain synchronization will be applied automatically even if [**Second-curtain synchronization**] is set.

## Flash exposure compensation

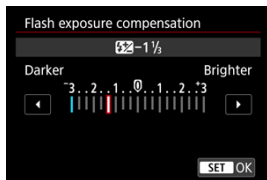

Just as exposure compensation is adjustable, you can also adjust flash output.

### Note

- If flash exposure compensation is set with the Speedlite, you cannot set the flash exposure compensation with the camera. If it is set with both the camera and Speedlite, the Speedlite's setting overrides the camera's.

## Flash exposure bracketing

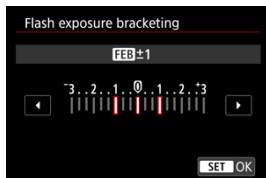

Speedlites equipped with flash exposure bracketing (FEB) can change the external flash output automatically as three shots are taken at once.

## Flash Custom Function Settings

For details on the Speedlite's Custom Functions, refer to the Instruction Manual of the Speedlite.

### 1. Select [Flash C.Fn settings].

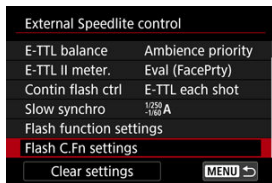

### 2. Set the desired functions.

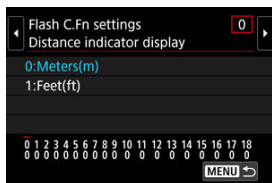

- Select the number.
- Select an option.

#### Caution

- With an EX series Speedlite, the Speedlite will always fire at full output if the [Flash metering mode] Custom Function is set to [TTL flash metering] (autoflash).
- The Speedlite's Personal Function (P.Fn) cannot be set or canceled from the camera's [📷: External Speedlite control] screen. Set it directly on the Speedlite.

## Clearing Flash Function Settings/Clearing All Speedlite Custom Functions

### 1. Select [Clear settings].

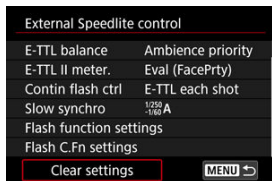

### 2. Select the settings to be cleared.

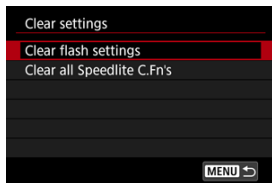

- Select [**Clear flash settings**] or [**Clear all Speedlite C.Fn's**].
- Select [**OK**] on the confirmation screen to clear all flash settings or Custom Function settings.

- ☑ [White Balance](#)
- ☑ [\[AWB\] Auto White Balance](#)
- ☑ [\[WB\] Custom White Balance](#) ☆
- ☑ [\[K\] Color Temperature](#)

White balance (WB) is for making the white areas look white. Normally, the Auto [AWB] (Ambience priority) or [AWBW] (White priority) setting will obtain the correct white balance. If natural-looking colors cannot be obtained with Auto, you can select the white balance to match the light source or set it manually by shooting a white object.

In [A+] mode, [AWB] (Ambience priority) is set automatically.

1. Press the <M-Fn> button (8).

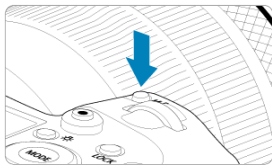

- With an image displayed on the screen, press the <M-Fn> button.

2. Select the white balance item.



- Turn the <8> dial to select the white balance setting item.

### 3. Select a white balance setting.









- Turn the <  > dial to make a selection.

#### Note

- For **[AWB]** and **[AWBW]** setting instructions, see [\[AWB\] Auto White Balance](#).
- To set your preferred color temperature, select **[K]** in **[C] White balance**, then turn the <  > dial.

(Approx.)

Display	Mode	Color Temperature (K: Kelvin)
<b>[AWB]</b>	<a href="#">Auto (Ambience priority)</a>	3000–7000
<b>[AWBW]</b>	<a href="#">Auto (White priority)</a>	
	Daylight	5200
	Shade	7000
	Cloudy, twilight, sunset	6000
	Tungsten light	3200
	White fluorescent light	4000
	When using Flash	Automatically set*
	<a href="#">Custom</a>	2000–10000
<b>[K]</b>	<a href="#">Color temperature</a>	2500–10000

\* Applicable with Speedlites having a color temperature transmission function. Otherwise, it will be fixed to approx. 6000K.



## White Balance

---

The human eye adapts to changes in lighting so that white objects look white under all kinds of lighting. Digital cameras determine white from the color temperature of lighting and, based on this, apply image processing to make color tones look natural in your shots.

## [AWB] Auto White Balance

With [AWB] (Ambience priority), you can slightly increase the intensity of the image's warm color cast when shooting a tungsten-light scene.

If you select [AWBW] (White priority), you can reduce the intensity of the image's warm color cast.

### 1. Select [📷: White balance].

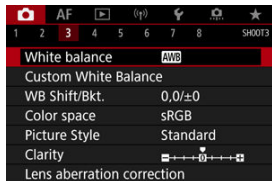

### 2. Select [AWB].

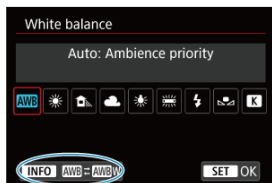

- With [AWB] selected, press the <INFO> button.

### 3. Select an option.

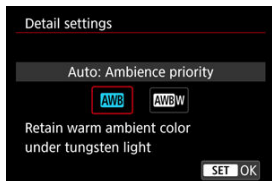

 Caution

**Precautions when set to [AWBW] (White priority)**

- The warm color cast of subjects may fade.
- When multiple light sources are included in the scene, the warm color cast of the picture may not be reduced.
- When using flash, the color tone will be the same as with [AWB] (Ambience priority).

With custom white balance, you can manually set the white balance for the specific light source of the shooting location. Make sure to perform this procedure under the light source at the actual location of the shoot.

## 1. Shoot a white object.



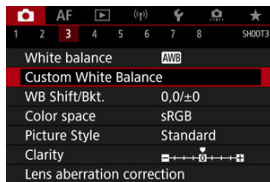

- Aim the camera at a plain white object, so that white fills the screen.
- Set the lens's focus mode switch to **<MF>** and shoot to obtain standard exposure for the white object.
- You can use any of the white balance settings.

## 2. Select [📷: Custom White Balance].



### 3. Import the white balance data.



- Turn the <  > dial to select the image captured in step 1, then press <  >.
- Select [OK] to import the data.

### 4. Select [: White balance].

### 5. Select the custom white balance.

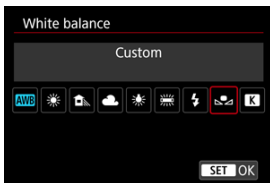

- Select [].

#### Caution

- If the exposure obtained in step 1 differs greatly from the standard exposure, a correct white balance may not be obtained.
- The following images cannot be selected: Images captured with the Picture Style set to [Monochrome], multiple-exposure images, cropped images, and images shot with another camera.



#### Note

- Instead of shooting a white object, you can also shoot a gray card or standard 18% gray reflector (commercially available).

## [K] Color Temperature

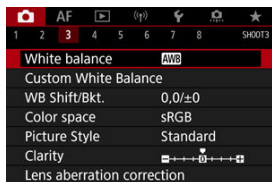

A value can be set representing the white balance color temperature.

### 1. Select [📷: White balance].

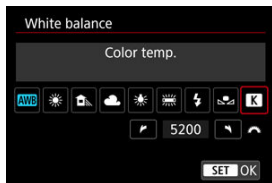

### 2. Set the color temperature.



- Select [K].
- Turn the <  > dial to set a color temperature, then press <  >.
- The color temperature can be set from approx. 2500K to 10000K in 100K increments.

#### Note

- When setting the color temperature for an artificial light source, set the white balance correction (magenta or green bias) as necessary.
- When setting [K] to a value measured with a commercially available color temperature meter, take some test shots in advance and adjust the setting as needed to compensate for any difference between the color temperature meter and the camera.

[White Balance Correction](#)

[White Balance Auto Bracketing](#)

You can correct the white balance that is set. This adjustment will have the same effect as using a commercially available color temperature conversion filter or color compensating filter.

---

## White Balance Correction

---

1. Select [: WB Shift/Bkt.].

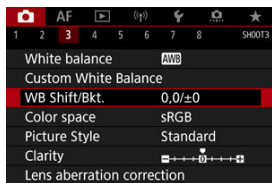





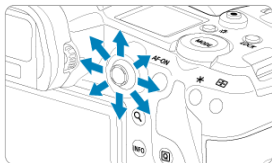

## 2. Set the white balance correction.

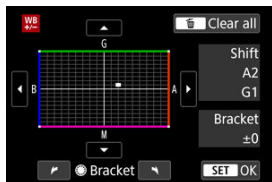

Sample setting: A2, G1



- Use <  > to move the "■" mark on the screen to your preferred position.
- B is for blue, A for amber, M for magenta, and G for green. White balance is corrected in the direction you move the mark.
- On the right of the screen, [**Shift**] indicates the direction and correction amount, respectively.
- Pressing the <  > button will cancel all the [**WB Shift/Bkt.**] settings.
- Press <  > to exit the setting.

### Note

- One level of the blue/amber correction is equivalent to approx. 5 mireds of a color temperature conversion filter. (Mired: Unit of measure for color temperature used to indicate values such as the density of a color temperature conversion filter.)

## White Balance Auto Bracketing

White balance bracketing enables you to capture three images at once with different color tones.

### Setting the white balance bracketing amount

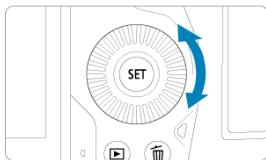

- In step 2 for [White Balance Correction](#), when you turn the  $\langle \odot \rangle$  dial, the "■" mark on the screen will change to "■ ■ ■" (3 points). Turning the dial clockwise sets the B/A bracketing, and turning it counterclockwise sets the M/G bracketing.

### B/A bias $\pm 3$ levels

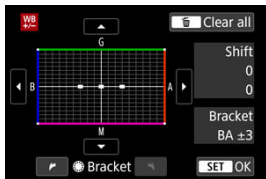

- On the right of the screen, **[Bracket]** indicates the bracketing direction and correction amount.
- Pressing the  $\langle \text{trash} \rangle$  button will cancel all the **[WB Shift/Bkt.]** settings.
- Press  $\langle \text{SET} \rangle$  to exit the setting.

#### Caution

- During white balance bracketing, the maximum burst for continuous shooting will be lower.
- Since three images are recorded for one shot, it takes longer to record the image to the card.



## Note

- The images will be bracketed in the following sequence: 1. Standard white balance, 2. Blue (B) bias, and 3. Amber (A) bias, or 1. Standard white balance, 2. Magenta (M) bias, and 3. Green (G) bias.
- You can also set white balance correction and AEB together with white balance bracketing. If you set AEB in combination with white balance bracketing, a total of nine images will be recorded for a single shot.
- The white balance icon blinks to indicate that white balance bracketing has been set.
- You can change the bracketing sequence (🔗) and number of shots (🔗) for the white balance bracketing.
- **Bracket** stands for bracketing.

The range of reproducible colors is called the “color space.” For normal shooting, sRGB is recommended.

In **[A+]** mode, **[sRGB]** is set automatically.

1. Select **[📷: Color space]**.
2. Set a color space option.

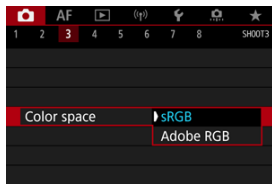

- Select **[sRGB]** or **[Adobe RGB]**, then press **< (SET) >**.

## Adobe RGB

This color space is mainly used for commercial printing and other professional applications. Recommended when using equipment such as Adobe RGB-compatible monitors or DCF 2.0 (Exif 2.21 or later) compatible printers.

### Note

- File names of still photos shot in the Adobe RGB color space begin with “\_”.
- The ICC profile is not appended. For the descriptions about the ICC profile, refer to the Digital Photo Professional Instruction Manual (EOS software).

## ☑ [Picture Style Characteristics](#)

## ☑ [Symbols](#)

Just by selecting a preset Picture Style, you can obtain image characteristics effectively matching your photographic expression or the subject.

In **[A+]** mode, **[A]** (Auto) is set automatically.

---

### 1. Select **[P]**: Picture Style.

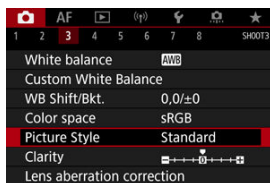

### 2. Select a Picture Style.



## Picture Style Characteristics

-  **Auto**

The color tone will be adjusted automatically to suit the scene. The colors will look vivid for blue skies, greenery and sunsets, particularly in nature, outdoor, and sunset scenes.

 **Note**

- If the desired color tone is not obtained with **[Auto]**, use another Picture Style.

-  **Standard**

The image looks vivid, sharp, and crisp. Suitable for most scenes.

-  **Portrait**

For smooth skin tones, with slightly less sharpness. Suited for close-up portraits. Skin tone can be adjusted by changing **[Color tone]** as described in [Settings and Effects](#).

-  **Landscape**

For vivid blues and greens, and very sharp and crisp images. Effective for impressive landscapes.

-  **Fine Detail**

For detailed rendering of fine subject contours and subtle textures. The colors will be slightly vivid.

-  **Neutral**

For retouching later on a computer. Makes images subdued, with lower contrast and natural color tones.

-  **Faithful**

For retouching later on a computer. Faithfully reproduces the actual colors of subjects as measured in daylight with a color temperature of 5200K. Makes images subdued, with lower contrast.

-  **Monochrome**

Creates black-and-white images.

 **Caution**

- Color images cannot be recovered from JPEG images shot with the **[Monochrome]** Picture Style.









-  **User Def. 1–3**

You can add a new style based on presets such as [**Portrait**] or [**Landscape**] or a Picture Style file, then adjust it as needed (). With any User Defined Picture Style that has not yet been registered, pictures will be taken with the same characteristics settings as with the default settings of [**Standard**].

## Symbols

Icons on the Picture Style selection screen represent [Strength], [Fineness], and [Threshold] for [Sharpness] as well as [Contrast] and other parameters. The numbers indicate the values for these settings specified for the respective Picture Style.

Picture Style	(S, F, T, C, N, N)	Picture Style	(S, F, T, C, N, N)
Auto	4, 2, 3, 0, 0, 0	Neutral	0, 2, 2, 0, 0, 0
Standard	4, 2, 3, 0, 0, 0	Faithful	0, 2, 2, 0, 0, 0
Portrait	3, 2, 4, 0, 0, 0	Monochrome	4, 2, 3, 0, N, N
Landscape	5, 2, 3, 0, 0, 0	User Def. 1	Standard
Fine Detail	4, 1, 1, 0, 0, 0	User Def. 2	Standard
Neutral	0, 2, 2, 0, 0, 0	User Def. 3	Standard

	<b>Sharpness</b>		
			<b>Strength</b>
			<b>Fineness</b>
			<b>Threshold</b>
	<b>Contrast</b>		
	<b>Saturation</b>		
	<b>Color tone</b>		
	<b>Filter effect (Monochrome)</b>		
	<b>Toning effect (Monochrome)</b>		

### ! Caution

- For movie recording, "\*\*" is indicated for the [Fineness] and [Threshold] parameters of [Sharpness]. [Fineness] and [Threshold] cannot be set for movie recording.



☑ [Settings and Effects](#)

☑  [Monochrome Adjustment](#)

You can customize any Picture Style by changing it from the default settings. For details on customizing **[Monochrome]**, see  [Monochrome Adjustment](#).

## 1. Select : Picture Style.

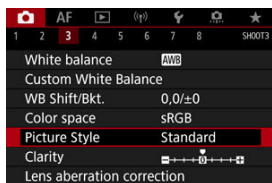

## 2. Select a Picture Style.



- Select the Picture Style to adjust, then press the < **INFO** > button.

### 3. Select an option.



- Select an option, then press < SET >.
- For details on settings and effects, see [Settings and Effects](#).

### 4. Set the effect level.



- Adjust the effect level, then press < SET >.









- Press the < MENU > button to save the adjusted setting and return to the Picture Style selection screen.
- Any settings you change from default values are displayed in blue.

## Note

- For movie recording, [Fineness] and [Threshold] for [Sharpness] cannot be set (not displayed).
- By selecting [Default set.] in step 3, you can restore the parameter settings of the respective Picture Style to the defaults.
- To shoot with the Picture Style you adjusted, first select the adjusted Picture Style, then shoot.

## Settings and Effects

	Sharpness		
	 <b>Strength</b>	0: Weak outline emphasis	7: Strong outline emphasis
	 <b>Fineness<sup>*1</sup></b>	1: Fine	5: Grainy
	 <b>Threshold<sup>*2</sup></b>	1: Low	5: High
	<b>Contrast</b>	-4: Low contrast	+4: High contrast
	<b>Saturation</b>	-4: Low saturation	+4: High saturation
	<b>Color tone</b>	-4: Reddish skin tone	+4: Yellowish skin tone

\* 1: Indicates the edge thinness that enhancement applies to. The smaller the number, the finer the outlines that can be emphasized.

\* 2: Contrast threshold between edges and surrounding image areas, which determines edge enhancement. The smaller the number, the more the outline will be emphasized when the contrast difference is low. However, noise tends to be more noticeable when the number is smaller.

### Filter effect

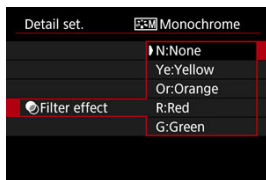

With a filter effect applied to a monochrome image, you can make white clouds or green trees stand out more.

Filter	Sample Effects
<b>N:None</b>	Normal black-and-white image with no filter effects.
<b>Ye:Yellow</b>	Blue sky will look more natural, and white clouds will look crisper.
<b>Or:Orange</b>	The blue sky will look slightly darker. The sunset will look more brilliant.
<b>R:Red</b>	The blue sky will look quite dark. Fall leaves will look crisper and brighter.
<b>G:Green</b>	Skin tones and lips will appear muted. Green tree leaves will look crisper and brighter.

#### Note

- Increasing [**Contrast**] will make the filter effect more pronounced.

### Toning effect

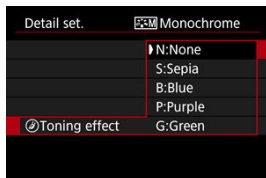

By applying a toning effect, you can create a monochrome image in the selected color. Effective when you want to create memorable images.

You can select a base Picture Style such as **[Portrait]** or **[Landscape]**, adjust it as desired, and register it under **[User Def. 1]** – **[User Def. 3]**. Useful when creating several Picture Styles with different settings.

Picture Styles that you have registered on the camera using EOS Utility (EOS software, [🔗](#)) can also be modified here.

## 1. Select **[📷: Picture Style]**.

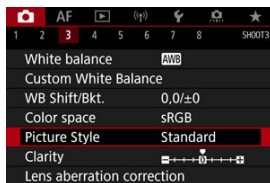

## 2. Select **[User Def.]**.

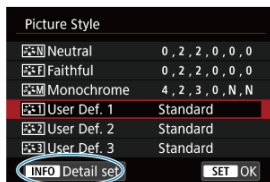

- Select **[User Def. \*]**, then press the **<INFO>** button.

### 3. Press <SET>.

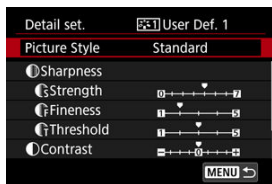

- With [Picture Style] selected, press <SET>.

### 4. Select a base Picture Style.

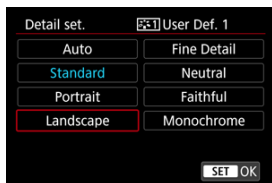

- Select the base Picture Style, then press <SET>.
- Also select styles this way when adjusting styles registered to the camera with EOS Utility (EOS software).

### 5. Select an option.

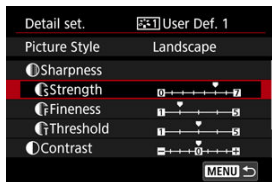

- Select an option, then press <SET>.

## 6. Set the effect level.

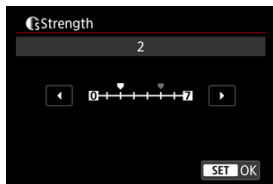

- Adjust the effect level, then press < **SET** >.
- For details, see [Picture Style Customization](#).

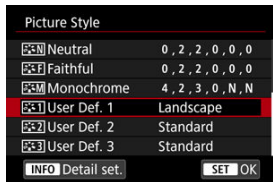

- Press the < **MENU** > button to save the adjusted setting and return to the Picture Style selection screen.
- The base Picture Style will be indicated on the right of [**User Def. \***].
- Blue style names in [**User Def. \***] have been changed from default values.

### Caution

- If a Picture Style is already registered under [**User Def. \***], changing the base Picture Style will clear the parameter settings of the previously registered User Defined Picture Style.
- You can restore the default [**User Def. \***] style and settings by selecting [**Basic settings**] in [**Reset camera**].

### Note

- To shoot with a registered Picture Style, select the registered [**User Def. \***], then shoot.
- For instructions on registering a Picture Style file to the camera, refer to the EOS Utility Instruction Manual.

You can adjust image clarity, as determined by the contrast of image edges. Set toward the negative end to make images look softer or toward the positive end for a sharper appearance.

## 1. Select [Clarity].

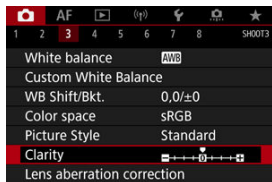

## 2. Set the effect level.

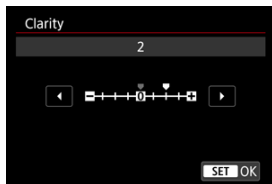

### Caution

- Setting clarity may darken or lighten the areas around boundaries in high-contrast images.
- The effect of this setting is not shown in images on the screen in still photo shooting.



- ☑ [Peripheral Illumination Correction](#)
- ☑ [Distortion Correction](#)
- ☑ [Digital Lens Optimizer](#)
- ☑ [Chromatic Aberration Correction](#)
- ☑ [Diffraction Correction](#)

Vignetting, image distortion, and other issues may be caused by lens optical characteristics. The camera can compensate for these phenomena by using **[Lens aberration correction]**.

1. Select **[: Lens aberration correction]**.

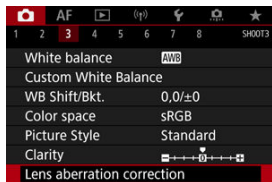

2. Select an option.

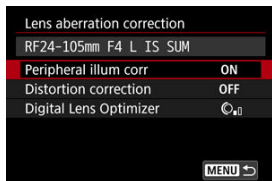

### 3. Select a setting.

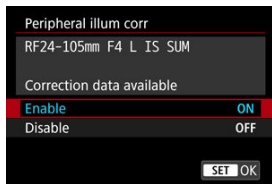

- Confirm that the name of the attached lens and (except for diffraction correction) [**Correction data available**] are displayed.
- If [**Correction data not available**] or [ ] is displayed, see [Digital Lens Optimizer](#).

#### ⚠ Caution

- Not available when shooting multiple exposures.

## Peripheral Illumination Correction

Vignetting (dark image corners) can be corrected.

#### ⚠ Caution

- Depending on shooting conditions, noise may appear on the image periphery.
- The higher the ISO speed, the lower the amount of correction will be.

#### 📄 Note

- The amount of correction applied will be lower than the maximum correction amount applied with Digital Photo Professional (EOS software).
- Peripheral illumination is corrected automatically in [A+] mode when correction data is registered on the camera.

## Distortion Correction

---

Distortion (image warping) can be corrected.

### Caution

- To correct distortion, the camera captures a narrower image area than the area seen in viewfinder shooting, which crops the image a little and slightly lowers the apparent resolution.
- Applying distortion correction may change the angle of view slightly.
- The amount of image cropped may vary between still photos and movies.

### Note

- With RF lenses, distortion correction during movie recording is supported.

## Digital Lens Optimizer

Various aberrations from lens optical characteristics can be corrected, along with diffraction and low-pass filter-induced loss of resolution.

If **[Correction data not available]** or  is displayed by **[Digital Lens Optimizer]**, you can use EOS Utility to add the lens correction data to the camera. For details, refer to the EOS Utility Instruction Manual.

### Caution

- Image processing after you shoot takes longer when set to **[High]** (which causes the access lamp to be illuminated longer).
- Maximum burst is lower with **[High]**. Image recording to the card also takes longer.
- Depending on shooting conditions, noise may be intensified together with the effects of correction. Image edges may also be emphasized. Adjust Picture Style sharpness or set **[Digital Lens Optimizer]** to **[Disable]** as needed before shooting.
- The higher the ISO speed, the lower the amount of correction will be.
- For movie recording, **[Digital Lens Optimizer]** will not appear. (Correction is not possible.)
- The effect of Digital Lens Optimizer cannot be checked on the screen at the time of shooting.

### Note

- With **[Digital Lens Optimizer]** set to **[Standard]** or **[High]**, **[Chromatic aberr corr]** and **[Diffraction correction]** are not displayed, but they are both set to **[Enable]** for shooting.

## Chromatic Aberration Correction

---

Chromatic aberration (color fringing around subjects) can be corrected.



### Note

- **[Chromatic aberr corr]** is not displayed when **[Digital Lens Optimizer]** is set to **[Standard]** or **[High]**.

## Diffraction Correction

---

Diffraction (loss of sharpness caused by the aperture) can be corrected.

### Caution

- Depending on shooting conditions, noise may be intensified together with the effects of correction.
- The higher the ISO speed, the lower the amount of correction will be.

### Note

- "Diffraction correction" corrects degraded resolution not only from diffraction but also from the low-pass filter and other factors. Thus, correction is also effective for exposures with the aperture wide open.
- **[Diffraction correction]** is not displayed when **[Digital Lens Optimizer]** is set to **[Standard]** or **[High]**.

---

### Caution

#### General precautions for lens aberration correction

- Lens aberration correction cannot be applied to existing JPEG images.
- When using a non-Canon lens, setting the corrections to **[Disable]** is recommended even if **[Correction data available]** is displayed.
- Magnifying the periphery of the image may display parts of the image that will not be recorded.
- The amount of correction (except diffraction correction) is less for lenses that do not provide distance information.

 **Note****General notes for lens aberration correction**

- Effects of lens aberration correction vary by lens and shooting conditions. Also, the effect may be difficult to discern depending on the lens used, shooting conditions, etc.
- If the correction is difficult to discern, magnifying and checking the image after shooting is recommended.
- Corrections are applied even when an extender or life-size converter is attached.
- If the correction data for the attached lens is not registered to the camera, the result will be the same as when the correction is set to **[Disable]** (except for diffraction correction).
- If necessary, refer to the EOS Utility Instruction Manual as well.

Noise that tends to occur in long exposures at shutter speeds of one sec. or slower can be reduced.

---

1. Select [**Ⓜ**: Long exp. noise reduction].

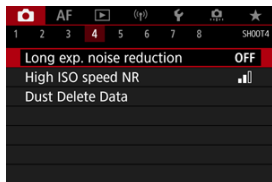

2. Set a reduction option.

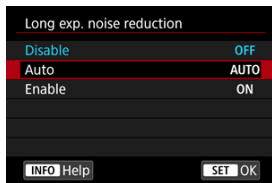

- **Auto**  
For images exposed for 1 sec. or longer, noise reduction is performed automatically if noise typical of long exposures is detected. This setting is effective enough in most cases.
- **Enable**  
Noise reduction is performed for all images exposed for 1 sec. or longer. The [**Enable**] setting may reduce noise that cannot be detected with the [**Auto**] setting.



 **Caution**

- With **[Auto]** or **[Enable]** set, noise reduction after you shoot may take as long as exposure for the shot.
- Images may look grainier with the **[Enable]** setting than with the **[Disable]** or **[Auto]** setting.
- **[BUSY]** is displayed as noise is reduced, and the shooting screen is not displayed until processing is finished, when you can shoot again.

You can reduce the image noise generated. This function is especially effective when shooting at high ISO speeds. When shooting at low ISO speeds, the noise in the darker parts of the image (shadow areas) can further be reduced.

## 1. Select [📷: High ISO speed NR].

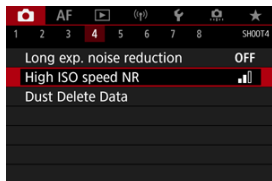

## 2. Set the level.



- **Low, Standard, High**  
The camera applies an amount of noise reduction corresponding to your specified level.
- **Multi Shot Noise Reduction**  
Applies noise reduction with higher image quality than **[High]**. For a single photo, four shots are taken continuously and aligned and merged automatically into a single JPEG image.  
Note that **[Multi Shot Noise Reduction]** is not available with image quality set to RAW or RAW+JPEG.

### Precautions on Multi Shot Noise Reduction

- If there is significant misalignment in the image due to camera shake, the noise reduction effect may become smaller.
- Be careful about camera shake in handheld shots. Using a tripod is recommended.
- If you shoot a moving subject, the moving subject may leave afterimages.
- Auto image alignment may not function properly with repetitive patterns (lattice, stripes, etc.) or flat, single-tone images.
- If the subject's brightness changes as the four consecutive shots are taken, irregular exposure in the image may result.
- After shooting, it may take some time to record an image to the card after performing noise reduction and merging the images. "BUSY" is displayed as images are processed, and shooting is not possible until processing is finished.
- **[Multi Shot Noise Reduction]** is not available when any of these features are set: bulb exposures, AEB or WB bracketing, RAW or RAW+JPEG, long exposure noise reduction, multiple exposures, HDR mode, HDR PQ, focus bracketing, or electronic shutter.
- Flash photography is not available. Note that the AF-assist beam of Speedlites may be fired, depending on the **[AF: AF-assist beam firing]** setting.
- **[Multi Shot Noise Reduction]** is not available (not displayed) when recording movies.
- The camera automatically switches to **[Standard]** when RAW or RAW+JPEG image quality is set.
- The camera automatically switches to **[Standard]** if you set the power switch to **< OFF >**, replace the battery or card, or switch to **[A+]** or **[BULB]** mode or movie recording.

## ☑ [Preparation](#)

## ☑ [Dust Delete Data Appending](#)

Dust Delete Data used to erase dust spots can be appended to images in case sensor cleaning leaves dust on the sensor. The Dust Delete Data is used by Digital Photo Professional (EOS software) to erase the dust spots automatically.

---

## Preparation

---

- Use an RF or EF lens.
- Prepare a solid white object such as a sheet of paper.
- Set the lens focal length to 50 mm or longer.
- Set the lens's focus mode switch to <MF> and set the focus to infinity ( $\infty$ ). If the lens has no distance scale, rotate the camera to face toward you and turn the focusing ring clockwise all the way.

### 1. Select [📷: Dust Delete Data].

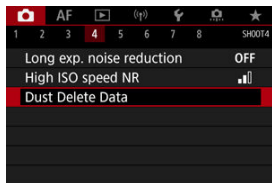

## 2. Select [OK].

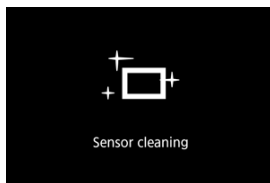
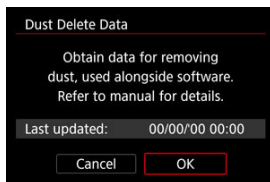

- After the automatic self-cleaning of the sensor is performed, a message will appear. Although there will be a mechanical sound of the shutter during the cleaning, no picture is taken.

### 3. Shoot a plain white object.

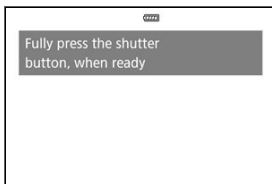

- Shoot with a plain white object (such as a new sheet of white paper) filling the screen, at a distance of 20–30 cm (0.7–1.0 ft.).
- Since the image will not be saved, the data can still be obtained even if there is no card in the camera.

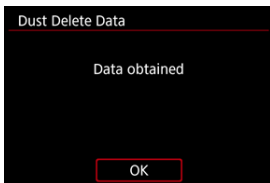

- When the picture is taken, the camera will start collecting the Dust Delete Data. When the Dust Delete Data is obtained, a message will appear.
- If the data is not obtained successfully, an error message will appear. Check the information in [Preparation](#), select **[OK]**, and shoot again.



## Dust Delete Data Appending

The camera will append the Dust Delete Data obtained to all shots from now on. Acquiring Dust Delete Data before shooting is recommended.

For details about using Digital Photo Professional (EOS software) to erase dust spots automatically, refer to the Digital Photo Professional Instruction Manual.

File size is essentially unaffected by Dust Delete Data appended to images.

### Caution

- Dust Delete Data is not obtained when EF-S lenses are used, or when [:  **Cropping/aspect ratio**] is set to [**1.6x (crop)**].
- Dust Delete Data is not added to images when [**Distortion correction**] is set to [**Enable**].
- If the object has any pattern or design, it may be recognized as dust data and affect the accuracy of the dust deletion with the Digital Photo Professional (EOS software).

[☑ Merging Multiple Exposures with a RAW Image Recorded on the Card](#)

[☑ Checking and Deleting Multiple Exposures During Shooting](#)

As you shoot multiple exposures (2–9), you can see how the images will be merged into a single image.

---

1. Select [: Multiple exposure].

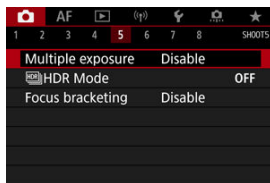



## 2. Set [Multiple exposure].

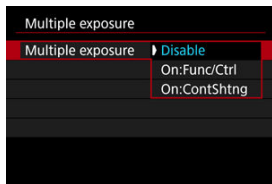

- Select an option, then press  $\langle$  **SET**  $\rangle$ .
- To exit shooting multiple exposures, select **[Disable]**.
  
- **On:Func/Ctrl**  
Convenient when shooting multiple exposures gradually as you check the results. During continuous shooting, the continuous shooting speed will decrease greatly.
  
- **On:ContShtng**  
Used for continuous multiple exposures of moving subjects. Continuous shooting is possible, but the following operations are disabled during shooting: menu screen viewing, image review after capture, image playback, and undo last image (🔍).  
Note that the single exposures used for merging are discarded, and only the multiple-exposure image is saved.

### ⚠ Caution

- Multiple exposures may not be available with some lenses.

### 3. Set [Multi-expos ctrl].

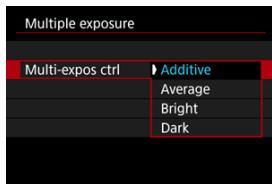

- Select a merging option, then press < (SET) >.

- **Additive**

The exposure of each single image captured is added cumulatively. Based on [**No. of exposures**], set negative exposure compensation. Follow these basic guidelines to set the exposure compensation amount.

**Exposure compensation setting guidelines, by number of exposures**

Two exposures: -1 stop, three exposures: -1.5 stops, four exposures: -2 stops

- **Average**

Based on the [**No. of exposures**], negative exposure compensation is set automatically as you shoot multiple exposures. If you shoot multiple exposures of the same scene, the exposure of the subject's background will be automatically controlled to obtain the standard exposure.

- **Bright/Dark**

Brightness (or darkness) of the base image and added images is compared at the same position, and bright (or dark) portions are retained. Some overlapping colors may be mixed, depending on the relative brightness (or darkness) of the images.

#### 4. Set [No. of exposures].



- Select the number of exposures, then press < **SET** >.

#### 5. Specify the images to save.

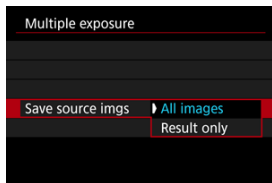

- To save all single exposures and the multiple-exposure image, select **[All images]** and press < **SET** >.
- To save only the multiple-exposure image, select **[Result only]** and press < **SET** >.

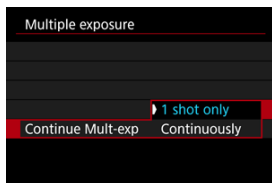

## 6. Set [Continue Mult-exp].



- Select an option, then press < **SET** >.
- With **[1 shot only]**, multiple-exposure shooting will be canceled automatically after the shooting ends.
- With **[Continuously]**, multiple-exposure shooting continues until the setting in step 2 is set to **[Disable]**.

## 7. Shoot the first exposure.



- When **[On:Func/Ctrl]** is set, the captured image will be displayed.
- The **[**] icon blinks.
- The number of remaining exposures is indicated on the screen (1) for reference.
- Pressing the < **[**] > button enables you to view the captured image (**[**]).

## 8. Shoot the next exposures.

- Images captured so far are displayed merged. For only image display, press the < INFO > button repeatedly.
- As you shoot, you can view the multiple-exposure image so far, check exposure, and see how the images will be merged by holding down the depth-of-field preview button (or the button assigned to **[Depth-of-field preview]** in [ Custom buttons]).
- Multiple-exposure shooting will end when the set number of exposures are taken.



### Note

- With **[On:Func/Ctrl]**, you can press the < > button to view the multiple-exposure image so far or delete the previous single exposure ().
- As shooting information, the multiple-exposure image has information captured for the last shot.

## Caution

- The image quality, ISO speed, Picture Style, high ISO speed noise reduction, color space, etc. set for the first single exposure will also be set for the subsequent exposures.
- If [Picture Style] is set to [Auto], [Standard] will be applied for shooting.
- With [On:Func/Ctrl] and [Additive] set, any noise, irregular colors, banding, or similar issues affecting images displayed as you shoot may look different in the final multiple-exposure image.
- With multiple exposures, the more exposures there are, the more noticeable the noise, irregular colors, and banding will be.
- Image processing after you finish shooting multiple exposures takes longer when [Additive] is set (which causes the access lamp to be illuminated longer).
- Brightness and noise of the final multiple-exposure image will be different from that of multiple-exposure images captured and displayed merged in step 8.
- Multiple-exposure shooting is canceled if you set the power switch to < OFF > or switch batteries or cards.
- Multiple-exposure shooting ends if you switch to [(A+)]/[C1P]/[C2P]/[C3P]/[P] shooting modes.
- If you connect the camera to a computer, multiple-exposure shooting will not be possible. If you connect the camera to a computer during shooting, multiple-exposure shooting will end.



## Merging Multiple Exposures with a RAW Image Recorded on the Card

You can select a RAW image recorded on the card as the first single exposure. The selected RAW image will remain intact.

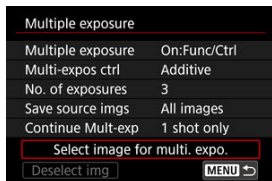
### 1. Select [Select image for multi. expo.].



## 2. Select the first image.

- Turn the <  > dial to select the first image, then press <  >.
- Select [OK].
- The file number of the selected image will be displayed at the bottom of the screen.





## 3. Take the picture.

- When you select the first image, the number of remaining exposures as set with [No. of exposures] will decrease by 1.

### Images you can select

Lens Attached	Cropped Shooting	Supported Images
RF or EF lens	Disabled	RAW images captured at full size
	Enabled	RAW images from cropped shooting or taken with an EF-S lens
EF-S lens	—	

#### Caution

- JPEG/HEIF images cannot be selected.
- These images cannot be selected as the first single exposure: images shot with  **Highlight tone priority** set to [Enable] or [Enhanced] or with   **Cropping/aspect ratio** set to an option other than [Full-frame] or [1.6x (crop)].
- [Disable] is applied for  **Lens aberration correction** and  **Auto Lighting Optimizer**, regardless of the settings of the image selected as the first single exposure.
- The ISO speed, Picture Style, high ISO speed noise reduction, color space, etc. set for the first image will also be applied for the subsequent images.
- If Picture Style is [Auto] for the image selected as the first image, [Standard] will be applied for shooting.
- You cannot select an image taken with another camera.
- Images that cannot be merged may be displayed.



#### Note

- You can also select a RAW image used in multiple-exposure shooting.
- Select [**Deselect img**] to cancel image selection.



## Checking and Deleting Multiple Exposures During Shooting

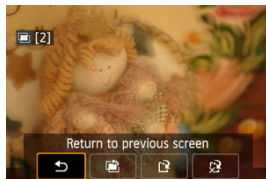

To view the multiple-exposure image so far, check exposure, and see how the images are merged, you can press the < [▶] > button before you finish shooting your specified number of exposures (when [On:Func/Ctrl] is set, but not with [On:ContShtng]).

Pressing the < [🗑] > button will display the operations possible during multiple-exposure shooting.

Option	Description
Return to previous screen	The screen before you pressed the < [🗑] > button will reappear.
Undo last image	Deletes the last image you shot (enabling you to replace it by shooting again). The number of remaining exposures will increase by 1.
Save and exit	With [Save source imgs: All images], saves all single exposures and the multiple-exposure image created so far and exits multiple-exposure shooting. With [Save source imgs: Result only], saves only the multiple-exposure image created so far and exits multiple-exposure shooting.
Exit without saving	Exits the multiple-exposure shooting without saving the image.

### ⚠ Caution

- During multiple-exposure shooting, you can only play back multiple-exposure images.

### ? FAQ

#### ● Are there any restrictions on the image quality?

All single exposures and the multiple-exposure image are captured at your specified image quality.

#### ● Can I merge images recorded on the card?

With [Select image for multi. expo.], you can select the first single exposure from the images recorded on the card (🔗). Note that you cannot merge multiple images already recorded on the card.

- **How are multiple-exposure files numbered?**

With the camera set to save all images, multiple-exposure image files are named with the next number after the number of the last single exposure used to create them.

- **Will auto power off take effect during multiple-exposure shooting?**

During multiple-exposure shooting, auto power off will not take effect. Note that before you start multiple-exposure shooting, auto power off automatically takes effect at the time set in the **[Auto power off]** option of **[P: Power saving]**, which will cancel multiple-exposure shooting.

 [Effects](#)

You can shoot still photos with clipped highlights and shadows reduced for a high dynamic range of tones even in high-contrast scenes. HDR shooting is effective for landscape and still-life shots.

**With HDR shooting, three images of different exposures (standard exposure, underexposure, and overexposure) are captured consecutively for each shot and then merged together automatically. The HDR image is recorded as a JPEG image.**

\* HDR stands for High Dynamic Range.

1. Select [ HDR] HDR Mode].



2. Set [Adjust dyn range].

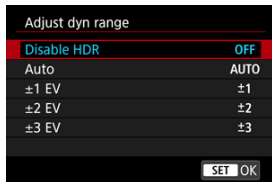

- Selecting [**Auto**] will have the dynamic range set automatically depending on the image's overall tonal range.
- The higher the number, the wider the dynamic range will be.
- To exit HDR shooting, select [**Disable HDR**].

### 3. Set [Effect].

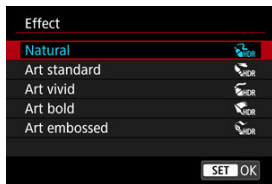

- See [Effects](#) for details on the settings and effects.

### 4. Set [Continuous HDR].

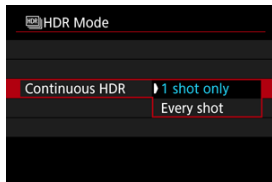

- With **[1 shot only]**, HDR shooting is canceled automatically after you finish shooting.
- With **[Every shot]**, HDR shooting continues until the setting in step 2 is set to **[Disable HDR]**.

### 5. Set [Auto Image Align].

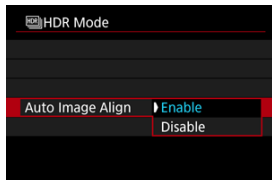

- For handheld shooting, select **[Enable]**. When using a tripod, select **[Disable]**.

## 6. Specify the images to save.

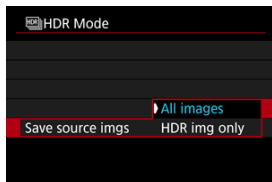



- To save the three images captured and the resulting HDR image, select [**All images**].
- To save only the HDR image, select [**HDR img only**].





## 7. Take the picture.

- When you press the shutter button completely, three consecutive images will be captured, and the HDR image will be recorded to the card.

## Caution

- RAW HDR images are captured in JPEG  image quality. RAW+JPEG HDR images are captured in the specified JPEG image quality.
- Expanded ISO speeds (L, H) are not available in HDR shooting. HDR shooting is possible within ISO 100–51200 (varies depending on the settings of **[Minimum]** and **[Maximum]** for **[ISO speed range]**).
- The flash will not fire during HDR shooting.
- AEB is not available.
- If you shoot a moving subject, the moving subject may leave afterimages.
- In HDR shooting, three images are captured with different shutter speeds set automatically. For this reason, even in **[Fv]**, **[Tv]**, and **[M]** modes, the shutter speed will change, relative to your specified speed.
- To prevent camera shake, a high ISO speed may be set.
- When shooting HDR images with **[Auto Image Align]** set to **[Enable]**, AF point display information () and Dust Delete Data () will not be appended to the image.
- If you perform handheld HDR shooting with **[Auto Image Align]** set to **[Enable]**, image periphery will be slightly trimmed and resolution will be slightly lowered. Also, if the images cannot be aligned properly due to camera shake, etc., auto image alignment may not take effect. Note that when shooting with excessively bright (or dark) exposure settings, auto image alignment may not work properly.
- If you perform handheld HDR shooting with **[Auto Image Align]** set to **[Disable]**, the three images may not be properly aligned and the HDR effect may be reduced. Using a tripod is recommended.
- Auto image alignment may not function properly with repetitive patterns (lattice, stripes, etc.) or flat, single-tone images.
- Subjects such as the sky or white walls may not be rendered with smooth gradation and may have noise or irregular exposure or colors.
- HDR shooting under fluorescent or LED lighting may result in unnatural color reproduction of the illuminated areas.
- With HDR shooting, the images will be merged, then saved to the card, so it may take some time. **[BUSY]** appears on the screen as images are processed, and shooting is not possible until processing is finished.

## Effects

-  **Natural**  
For images preserving a wide tonal range where the highlight and shadow details would otherwise be lost. Clipped highlights and shadows will be reduced.
-  **Art standard**  
While the clipped highlights and shadows will be reduced more than with **[Natural]**, the contrast will be lower, and the gradation flatter to have the picture look like a painting. The subject outlines will have bright (or dark) edges.
-  **Art vivid**  
The colors are more saturated than with **[Art standard]**, and the low contrast and flat gradation create a graphic art effect.
-  **Art bold**  
The colors are the most saturated, making the subject pop out, and the picture looks like an oil painting.
-  **Art embossed**  
The color saturation, brightness, contrast and gradation are decreased to make the picture look flat, so that the picture looks faded and old. The subject outlines will have intensely bright (or dark) edges.

	Art standard	Art vivid	Art bold	Art embossed
Saturation	Standard	High	Higher	Low
Outline emphasis	Standard	Weak	Strong	Stronger
Brightness	Standard	Standard	Standard	Dark
Gradation	Flat	Flat	Flat	Flatter



### Note

- Each effect will be applied based on the characteristics of the Picture Style  currently set.

Focus bracketing enables continuous shooting with the focal distance changed automatically after a single shot. From these images, you can create a single image in focus over a wide area by using an application that supports depth compositing, such as Digital Photo Professional (EOS software).

## 1. Select [Focus bracketing].

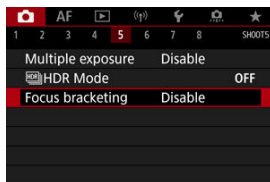

## 2. Set [Focus bracketing].

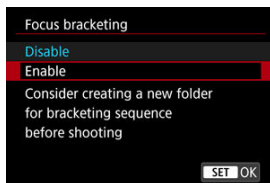

- Select [Enable].



### 3. Set [Number of shots].



- Specify the number of images captured per shot.
- Can be set in a range of [2]–[999].

### 4. Set [Focus increment].

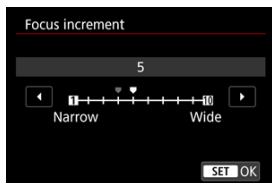

- Specify how much to shift the focus. This amount is automatically adjusted to suit the aperture value at the time of shooting. Larger aperture values increase the focus shift and make focus bracketing cover a wider range under the same focus increment and number of shots.
- After completing the settings, press < (SET) >.

## 5. Set [Exposure smoothing].

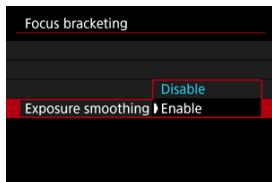

- You can suppress changes in image brightness during focus bracketing by setting [**Exposure smoothing**] to [**Enable**], which compensates for differences between the displayed and actual aperture value (effective f/number), which varies by focal position.



## 6. Take the picture.

- To save your shots in a new folder, tap [**📁**] and select [**OK**].
- Focus at the nearer end of your preferred focal range, then press the shutter button completely.
- Once shooting begins, release the shutter button.
- The camera shoots continuously, shifting the focal position toward infinity.
- Shooting ends after your specified number of images, or at the far end of the focal range.

## Caution

- Focus bracketing is intended for still photo shooting on a tripod.
- Shooting with a wider angle of view is recommended. After depth compositing, you can crop the image if necessary.
- For details on lenses compatible with this feature, visit the Canon website.
- Set [**Exposure smoothing**] to [**Disable**] with the following lenses, because they may cause changes in image brightness.
  - EF100mm f/2.8L Macro IS USM
  - EF180mm f/3.5L Macro USM
  - EF-S60mm f/2.8 Macro USM
- Suitable [**Focus increment**] settings vary by subject. An unsuitable [**Focus increment**] setting may cause unevenness in composite images, or shooting may take more time because more shots are taken. Take some test shots to decide a suitable [**Focus increment**] setting.
- Combining the images will take longer when you have specified a higher numbers of shots.
- Flash photography is not possible.
- Shooting under flickering light may cause uneven images. In this case, lowering the shutter speed may give better results.
- Focus bracketing is not available when the lens's focus mode switch is set to <MF>.
- Canceling shooting in progress may cause exposure problems in the last image. Avoid using the last image when combining the images in Digital Photo Professional.

## Note

- Using a tripod, remote switch (sold separately, ) , or wireless remote control (sold separately, ) is recommended.
- For best results, set the aperture value in a range of f/5.6–11 before shooting.
- Details such as shutter speed, aperture value, and ISO speed are determined by conditions for the first shot.
- To cancel shooting, press the shutter button completely again.
- [**Focus bracketing**] reverts to [**Disable**] when the power switch is set to <OFF>.

# Interval Timer Shooting

---

With the interval timer, you can set the shooting interval and number of shots, so that the camera takes individual shots repeatedly according to your interval until your specified number of shots are taken.

---

1. Select [: Interval timer].

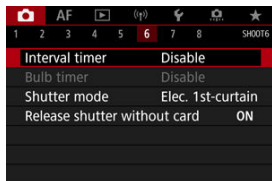

2. Select [Enable].

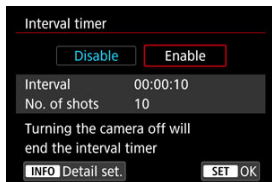

- Select [Enable], then press the <INFO> button.

### 3. Set the shooting interval and number of shots.

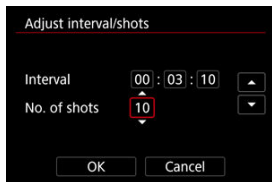

- Select an option to set (hours : minutes : seconds / number of shots).
- Press < **SET** > to display [↕].
- Set the desired number, then press < **SET** >. (Returns to [□].)
- **Interval**  
Can be set in a range of [00:00:01]–[99:59:59].
- **No. of shots**  
Can be set in a range of [01]–[99]. To keep the interval timer on indefinitely until you stop it, set [00].

### 4. Select [OK].

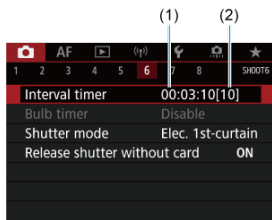

- The interval timer settings will be displayed on the menu screen.  
(1) Interval  
(2) Number of shots

## 5. Take the picture.

- First shot is taken and shooting continues according to the interval timer settings.
- During interval timer shooting, **[TIMER]** will blink.
- After the set number of shots are taken, the interval timer shooting will stop and be automatically canceled.



### Note

- Using a tripod is recommended.
- Taking test shots in advance is recommended.
- Even during interval timer shooting, you can still shoot as usual by pressing the shutter button completely. Note that the camera will prepare for the next interval timer shot approx. 5 sec. in advance, which will temporarily prevent operations such as adjusting shooting settings, accessing menus, and playing back images.
- If the next scheduled interval timer shot is not possible because the camera is shooting or processing images, it will be skipped. For this reason, fewer shots than specified will be taken.
- Even during interval timer operation, auto power off is triggered after approx. 8 sec. of inactivity, as long as **[Auto power off]** under **[P: Power saving]** is not set to **[Disable]**. When set to **[P: Eco mode]**, the display dims after 2 sec., and auto power off takes effect 6 sec. after this. The camera will automatically turn on again approx. 1 min. before the next shot.
- Can also be combined with AEB, white balance bracketing, multiple exposures, and HDR mode.
- To stop interval timer shooting, select **[Disable]** or set the power switch to **<OFF>**.

## Caution

- Do not point the camera toward an intense light source, such as the sun or an intense artificial light source. Doing so may damage the image sensor or the camera's internal components.
- Setting the lens's focus mode switch to < **AF** > prevents the camera from shooting unless subjects are in focus. Consider setting the mode to < **MF** > and focusing manually before shooting.
- If the shooting time is long, using the household power outlet accessories (sold separately) is recommended.
- Shooting long exposures or using shutter speeds longer than the shooting interval will prevent shooting at the specified interval. For this reason, fewer shots than specified will be taken. Using shutter speeds nearly the same as the shooting interval may also reduce the number of shots.
- If the time it takes to record to the card exceeds the shooting interval due to the shooting functions set or card performance, some of the shots may not be taken with the set intervals.
- When using flash with interval timer shooting, set an interval longer than the flash charge time. Intervals that are too short may prevent the flash from firing.
- Intervals that are too short may prevent shooting or autofocus.
- Interval timer shooting is canceled and reset to **[Disable]** if you set the power switch to < **OFF** >, set the shooting mode to **[BULB]/[C1P]/[C2P]/[C3P]/[P]**, or use EOS Utility (EOS software).
- During interval timer shooting, you cannot use [Remote Control Shooting](#) or remote-release shooting with a Speedlite.

You can choose the method of shutter release.

## 1. Select [📷: Shutter mode].

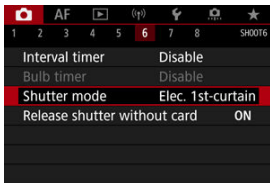

## 2. Select an option.

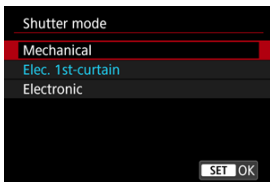

- **Mechanical**

Shooting activates the mechanical shutter. Recommended when shooting with the aperture of a bright lens wide open.

- **Elec. 1st-curtain**

Shooting only activates the second-curtain shutter.

- **Electronic**

Enables you to shoot without a shutter sound.



In continuous shooting, the camera always shoots at high speed (up to approx. 20 shots/sec.). Also during continuous shooting, the white frame is displayed repeatedly.



## Caution

- Defocused image areas may be incomplete when shooting near maximum aperture at high shutter speeds, depending on shooting conditions. If you dislike the appearance of defocused image areas, shooting as follows may give better results.
  - Shoot with an option other than **[Elec. 1st-curtain]**.
  - Lower the shutter speed.
  - Increase the aperture value.

### Precautions when set to **[Electronic]**

- Be responsible when using electronic shutter, and respect subject privacy and portrait rights.
- Some restrictions on shutter speed apply. Shutter speeds slower than 0.5 sec. are not available.
- The continuous shooting speed may become slower depending on the shooting conditions.
- Images of fast-moving subjects may look distorted.
- With some lenses and under some shooting conditions, lens focusing and aperture adjustment may be audible.
- Bands of light may be displayed and captured images may be affected by light and dark banding if you shoot with electronic shutter during flash firing by other cameras or under fluorescent lighting or other flickering light sources.
- Zooming during continuous shooting may cause changes in exposure even at the same f/number. For details, refer to the Canon website.
- **[Elec. 1st-curtain]** is used for bulb exposures.
- AEB shooting and flash photography are not available.
- Some functions will be restricted, but you can return to shooting with previous settings by switching to a setting other than **[Electronic]**.
- **[Enable]** is used for  **High speed display** when **[Expo. simulation]** is set to **[Enable]** in drive modes other than .

## Releasing Shutter without Card

---

You can set the camera not to shoot unless there is a card in the camera. The default setting is **[Enable]**.

---

1. Select [: Release shutter without card].

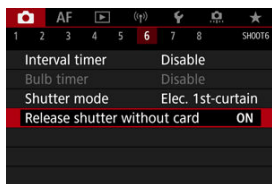

2. Select [Disable].

## Image Stabilizer (IS Mode)

---

### [Focal Length](#)

Image stabilization by the camera reduces camera shake in still photo shooting. It can provide effective stabilization even when your lens is not equipped with Image Stabilizer. When using a lens equipped with Image Stabilizer, set the lens's Image Stabilizer switch to <ON>.

---

1. Select [: IS (Image Stabilizer) mode].

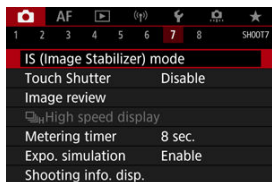

2. Select [IS mode].

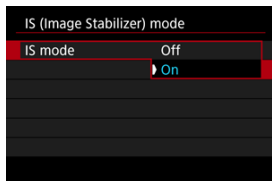

- Select [On].

### 3. Select [Still photo IS].



- **[Always]:** Provides constant image stabilization.
- **[Only for shot]:** Image stabilization is active only at the moment of shooting.

#### Caution

- **[📷: IS (Image Stabilizer) mode]** is not displayed in **[Fv]**, **[P]**, **[Tv]**, **[Av]**, **[M]**, or **[BULB]** shooting mode when an IS-equipped lens is attached.
- In some cases, this may not provide sufficient stabilization for certain lenses.

#### Note

- For details on image stabilization for movie recording, see [Movie Digital IS](#).

## Focal Length

Image stabilization based on your specified lens focal length is possible by setting the focal length when using lenses that do not support lens communication.

## 1. Select [Focal length].

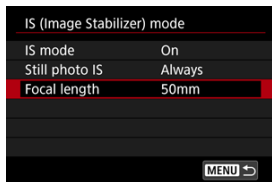

## 2. Set the focal length.

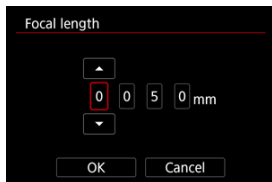

- Turn the < > dial to select the digit of the focal length.
- Press < > to display [].
- Set the desired number, then press < >. (Returns to [].)

## 3. Select [OK].

### Caution

- Set [: Release shutter w/o lens] to [Enable]. [Disable] prevents image stabilization.
- [Focal length] is not displayed when lenses are attached that support lens communication.

### Note

- Focal length can be set in a range of 1–1000 mm (in 1 mm increments).

## Shooting with the Touch Shutter

---

Just by tapping the screen, you can focus and take the picture automatically.

---

### 1. Enable the Touch Shutter.



- Tap [OFF] in the lower left of the screen.
- Each time you tap the icon, it will toggle between [OFF] and [ON].
- [ON] (Touch Shutter: Enable)  
The camera will focus on the spot you tap, then the picture will be taken.
- [OFF] (Touch Shutter: Disable)  
You can tap a spot to perform focusing on the spot. Press the shutter button completely to take the picture.

## 2. Tap the screen to shoot.



- Tap the face or subject on the screen.
- On the point you tap, the camera focuses (Touch AF) with your specified [AF method](#).
- When [C] is set, the AF point turns green when focus is achieved, then the picture is taken automatically.
- If focus is not achieved, the AF point turns orange and the picture cannot be taken. Tap the face or subject on the screen again.

### ⚠ Caution

- The camera shoots in single shooting mode regardless of the drive mode setting ([C], [H], or [L]).
- Tapping the screen focuses with [One-Shot AF], even if [AF operation] is set to [Servo AF].
- Tapping the screen in magnified view will not focus or take the picture.
- When shooting by tapping with [Review duration] in [Image review] set to [Hold], you can take the next shot by pressing the shutter button halfway or tapping [↩].

### 📌 Note

- To shoot with bulb exposure, tap the screen twice. Tap once to start exposure and again to stop it. Be careful not to shake the camera when tapping the screen.

# Image Review

---

- [Review Duration](#)
- [Viewfinder Review](#)

## Review Duration

---

To keep the image displayed immediately after you shoot, set to **[Hold]**, and if you prefer not to have the image displayed, set to **[Off]**.

1. Select **[: Image review]**.

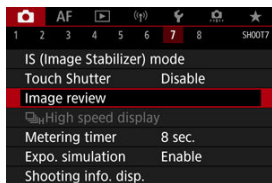

2. Select **[Review duration]**.

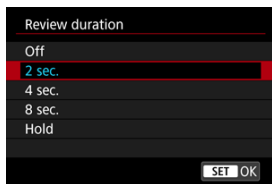

3. Set a time option.





#### Note

- When **[Hold]** is set, images are displayed as long as the time set in the **[Display off]** option of **[🔋: Power saving]**.

## Viewfinder Review

Set to **[Enable]** for viewfinder display of your shots immediately after you shoot.

1. Select **[Image review]**.

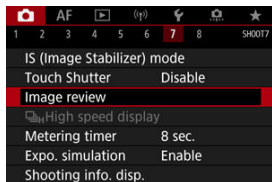

2. Select **[Viewfinder review]**.

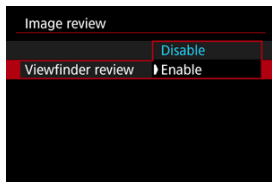

3. Select an option.

### Note

- **[Viewfinder review]** settings take effect when **[Image review]** is set to an option other than **[Off]**.

High-speed display that switches between each shot and the live image is available when shooting with **[AF: AF operation]** set to **[Servo AF]** and the drive mode set to **[C/H] [High speed continuous]**. Display is more responsive, making it easier to follow fast-moving subjects.

1. Select **[C/H] High speed display**.



2. Select an option.

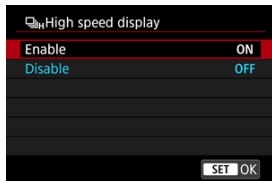

- Select **[Enable]** for display that switches between each shot and the live image.

## Caution

- Images may waver or flicker during high-speed display. This occurs more often at high shutter speeds. However, this does not affect shooting results.
- High-speed display is not performed for shutter speeds slower than 1/30 sec., aperture values higher than f/11, conditions that make autofocusing difficult, flash photography, or ISO expansion. It may also stop as you are shooting.



#### Note

- High-speed display is always used when [📷: Shutter mode] is set to [Electronic].

You can set how long the metering timer runs (which determines the duration of exposure value display/AE lock) after it is triggered by an action such as pressing the shutter button halfway.

---

1. Select [📷: Metering timer].

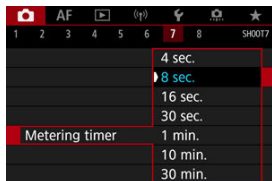

2. Set a time option.

With exposure simulation, image brightness more closely matches the actual brightness (exposure) of your shots.

---

## 1. Select [📷: Expo. simulation].

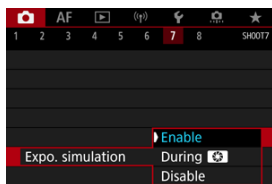

## 2. Set an option.

- **Enable (Exp.SIM)**

The displayed image brightness will be close to the actual brightness (exposure) of the resulting image. If you set exposure compensation, the image brightness will change accordingly.

- **During** 

Normally, the image is displayed at standard brightness, so it is easy to see (📷DISP). Only when you hold down the depth-of-field preview button will image brightness resemble actual brightness (exposure) of the resulting image (Exp.SIM).

- **Disable (📷DISP)**

The image is displayed at standard brightness, so it is easy to see. Even if you set exposure compensation, the image is displayed at the standard brightness.

# Shooting Information Display

---

- [Customizing Information on the Screen](#)
- [Customizing Information in the Viewfinder](#)
- [Viewfinder Vertical Display](#)
- [Grid](#)
- [Histogram](#)
- [Setting Focus Distance Display](#)
- [Clearing Settings](#)

You can customize the details and screens of information shown on the screen or in the viewfinder when you shoot.

---

## Customizing Information on the Screen

---

1. Select [: Shooting info. disp.].



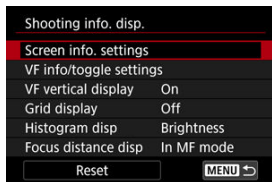

## 2. Select [Screen info. settings].

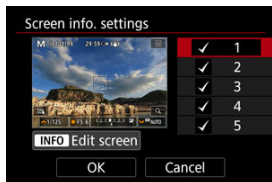

## 3. Select screens.





- Turn the <  > dial to select screens of information to show on the camera.
- For information you prefer not to display, press <  > to clear the checkmark [✓].
- To edit the screen, press the < INFO > button.

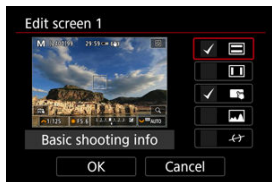

## 4. Edit the screen.



- Turn the <  > dial to select options to show on the screen of information.
- For items you prefer not to display, press <  > to clear the checkmark [✓].
- Select [OK] to register the setting.

## Customizing Information in the Viewfinder

1. Select []: Shooting info. disp.].



2. Select [VF info/toggle settings].

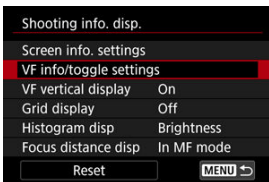



3. Select screens.

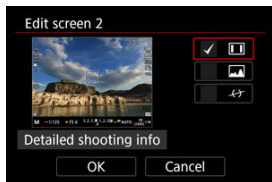

- Turn the dial to select screens of information to show on the camera.
- For information you prefer not to display, press to clear the checkmark [].
- To edit the screen, press the button.

#### 4. Edit the screen.



- Turn the <  > dial to select options to show on the screen of information.
- For items you prefer not to display, press <  > to clear the checkmark [✓].
- Select [OK] to register the setting.

## Viewfinder Vertical Display

You can select how viewfinder information is displayed when you are shooting still photos vertically.

1. Select [📷: Shooting info. disp.].



2. Select [VF vertical display].

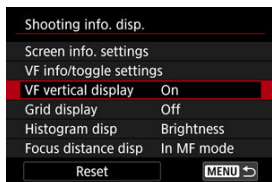

### 3. Select an option.

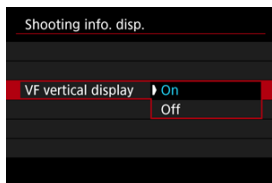

- **On**  
Information is automatically rotated, making it easier to read.
- **Off**  
Information is not automatically rotated.

A grid can be displayed on the screen and viewfinder.

1. Select [: Shooting info. disp.].



2. Select [Grid display].

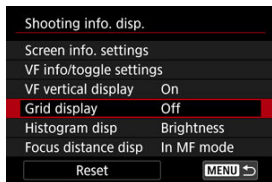

3. Select an option.



You can select the content and display size of the histogram.

1. Select [**☑**: Shooting info. disp.].



2. Select [Histogram disp].

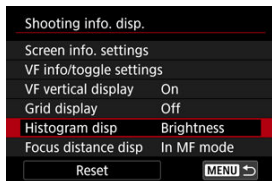

3. Select an option.

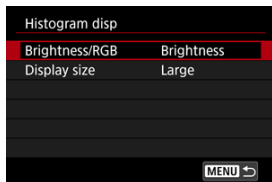

- Select the content ([**Brightness**] or [**RGB**]) and display size ([**Large**] or [**Small**]).

## Setting Focus Distance Display

You can display focus distance when using RF lenses. In focus distance display, you can select the timing and unit of measurement.

1. Select [📷: Shooting info. disp.].



2. Select [Focus distance disp.].

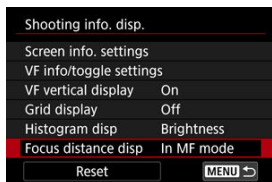

3. Select the timing of display.

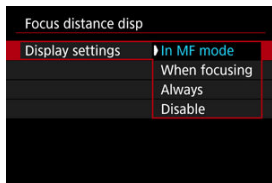



#### 4. Select the unit of measurement.

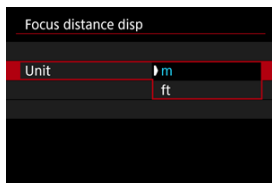

#### Note

- For certain RF lenses, magnification is also displayed.

## Clearing Settings

1. Select [: Shooting info. disp.].



2. Select [Reset].

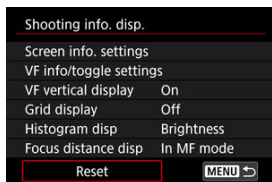

3. Select [OK].

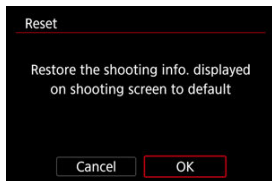

# Viewfinder Display Format

---

1. Select [VF]: VF display format].

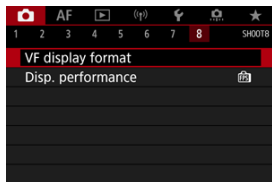

2. Select an option.

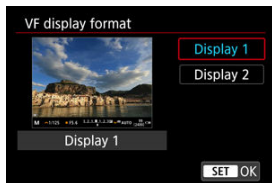

# Display Performance

---

You can select the performance parameter to prioritize in shooting screen display for still photos.

---

1. Select [: Disp. performance].

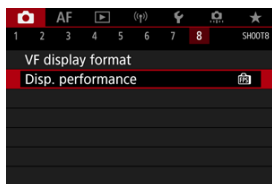

2. Select an option.

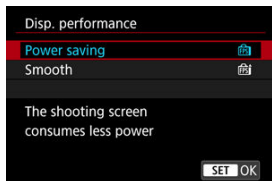

You can select one of four methods to measure the subject brightness. In [A+] mode, evaluative metering is set automatically.

---

## 1. Press the <Q> button (10).

- With an image displayed, press the <Q> button.

## 2. Select the metering mode.



- To select an item, turn the <DIAL> dial or press <UP/DOWN> up or down.
- To select the metering mode, turn the <DIAL> or <DIAL> dial, or press <LEFT/RIGHT> left or right.

### Evaluative metering

General-purpose metering mode suited even for backlit subjects. The camera adjusts the exposure automatically to suit the scene.

### Partial metering

Effective where there are much brighter lights around the subject due to backlight, etc. Covers approx. 6.1% of the area at the center of the screen.







### Spot metering

Effective when metering a specific part of the subject. Covers approx. 3.1% of the area at the center of the screen. The spot metering area is indicated on the screen.

## Center-weighted average

The metering across the screen is averaged, with the center of the screen weighted more heavily.

### Note

- By default, the camera will set the exposure as follows.  
With , holding down the shutter button halfway locks the exposure value (AE lock) after the camera focuses with One-Shot AF. With //, the exposure value is set at the moment the picture is taken (without locking the exposure value when the shutter button is pressed halfway).
- With : **AE lock meter. mode after focus** , you can set whether or not to lock the exposure (AE lock) once subjects are in focus with One-Shot AF.

Exposure compensation can brighten (increased exposure) or darken (decreased exposure) the standard exposure set by the camera.

Exposure compensation is available in **[Fv]**, **[P]**, **[Tv]**, **[Av]**, and **[M]** modes.

For details on exposure compensation when **[M]** mode and ISO Auto are both set, see [M: Manual Exposure](#), and see [Fv: Flexible-Priority AE](#) for **[Fv]** mode.

## 1. Check the exposure.

- Press the shutter button halfway and check the exposure level indicator.

## 2. Set the compensation amount.

Increased exposure, to brighten images



Decreased exposure, to darken images



- Set it by looking at the screen as you turn the < > dial.
- A  icon is displayed to indicate exposure compensation.

## 3. Take the picture.

- To cancel exposure compensation, set the exposure level **[ ]** to the standard exposure index (**[ ]**).

### Caution

- If **[Auto Lighting Optimizer]** () is set to any setting other than **[Disable]**, the image may still look bright even if decreased exposure compensation is set to darken images.



#### Note

- The exposure compensation amount will remain in effect even after you set the power switch to <OFF>.



## [AE Lock Effects](#)

You can lock the exposure when you want to set the focus and exposure separately or when you will take multiple shots at the same exposure setting. Press the < \* > button to lock the exposure, then recompose and take the picture. This is called AE lock. It is effective for shooting backlit subjects, etc.

---

### 1. Focus on the subject.

- Press the shutter button halfway.
- The exposure value will be displayed.

### 2. Press the < \* > button (ⓘ).



- A [\*] icon is displayed in the lower left of the screen to indicate that exposure is locked (AE lock).
- Each time you press the < \* > button, the current exposure setting is locked.

### 3. Recompose and take the picture.



- When you are to take more pictures while maintaining the AE lock, keep holding down the < \* > button and press the shutter button to take another picture.

#### Note

- AE lock is not possible with bulb exposures.

## AE Lock Effects

Metering Mode Selection	AF point selection	
	Automatic Selection	Manual Selection
	Exposure centered on the AF point in focus is locked.	Exposure centered on the selected AF point is locked.
	Center-weighted exposure is locked.	

\* When is set with the lens's focus mode switch set to < MF >, center-weighted exposure is locked.

# General Still Photo Shooting

---

 [Information Display](#)



 [General Still Photo Shooting Precautions](#)

## Information Display

---

For details on the icons displayed for still photo shooting, see [Information Display](#).

### Note

- White display of the **[Exp.SIM]** icon indicates that your shots will be about as bright as the image displayed.
- If the **[Exp.SIM]** icon is blinking, it indicates that the image is displayed at a brightness that differs from the actual shooting result because of low- or bright-light conditions. However, the actual image recorded will reflect the exposure setting. Note that the noise may be more noticeable than the actual image recorded.
- Exposure simulation may not be performed under some shooting settings. The **[Exp.SIM]** icon and histogram will be displayed in gray. The image will be displayed on the screen at the standard brightness. The histogram may not be properly displayed in low- or bright-light conditions.
- The histogram can be displayed when [: **Expo. simulation**] is set to **[Enable]** ().

## General Still Photo Shooting Precautions

### ! Caution

- Do not point the camera toward an intense light source, such as the sun or an intense artificial light source. Doing so may damage the image sensor or the camera's internal components.

### Image quality

- When you shoot at high ISO speeds, noise (such as dots of light and banding) may become noticeable.
- Shooting in high temperatures may cause noise and irregular colors in the image.
- Frequent shooting over an extended period may cause high internal temperatures and affect image quality. When you are not shooting, always turn off the camera.
- If you shoot a long exposure while the camera's internal temperature is high, image quality may decline. Stop shooting and wait a few minutes before shooting again.

### White [🔴] and red [🔴] internal temperature warning icons

- White [🔴] or red [🔴] icons indicate high internal camera temperature, caused by factors such as extended shooting or use in hot environments.
- The white [🔴] icon indicates that the image quality of still photos will decline. Stop shooting for a while and allow the camera to cool down.
- Shooting at low ISO speeds instead of high speeds is recommended when the white [🔴] icon is displayed.
- The red [🔴] icon indicates that shooting will soon be terminated automatically. Shooting will not be possible again until the camera cools down internally, so stop shooting temporarily or turn off the camera and let it cool down a while.
- Shooting in hot environments over extended periods will cause the white [🔴] or red [🔴] icon to appear sooner. When you are not shooting, always turn off the camera.
- If the camera's internal temperature is high, the quality of images shot with a high ISO speed or long exposure may decline even before the white [🔴] icon is displayed.

### Shooting results

- In magnified view, the shutter speed and aperture value will be displayed in orange. If you take the picture in magnified view, the exposure may not come out as desired. Return to the normal view before taking the picture.
- Even if you take the picture in magnified view, the image will be captured with the image area of the normal view.

## Images and display





- Under low- or bright-light conditions, the displayed image may not reflect the brightness of the captured image.
- Although noise may be noticeable in images under low light (even at low ISO speeds), there will be less noise in your shots, due to differences in image quality between displayed and captured images.
- The screen may flicker if the light source (lighting) changes. In this case, stop shooting temporarily and resume under the light source you will use.
- Pointing the camera at different direction may momentarily prevent correct display of brightness. Wait until the brightness level stabilizes before shooting.
- If there is a very bright light source in the image, the bright area may appear black on the screen. However, the actual captured image will correctly show the bright area.
- Under low light, bright [: **Screen brightness**] settings may cause noise or irregular colors in images. However, the noise or irregular colors will not be recorded in the captured image.
- When you magnify the image, the image sharpness may look more pronounced than in the actual image.

## Lens

- If the attached lens has an Image Stabilizer and you set the Image Stabilizer switch to < **ON** >, the Image Stabilizer will operate at all times even if you do not press the shutter button halfway. The Image Stabilizer consumes battery power and may decrease the number of available shots depending on the shooting conditions. When the Image Stabilizer is not necessary, such as when using a tripod, it is recommended that you set the Image Stabilizer switch to < **OFF** >.
- With EF lenses, focus preset during shooting is only available when using (super) telephoto lenses equipped with this function released in and after the second half of 2011.



## Note

- The field of view is approx. 100% (with image quality set to JPEG .
- If the camera is idle over an extended period, the screen will turn off automatically after the time set in [**Auto power off**] or [**Viewfinder off**] under [: **Power saving**]. The camera then turns off automatically after the time set in [**Auto power off**] (.
- Using a commercially available HDMI cable, you can display images on a television (). Note that no sound will be output.

# Movie Recording

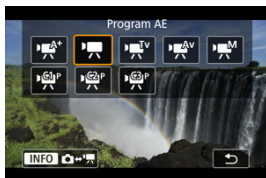

To prepare for movie recording, press the < **MODE** > button, then press the < **INFO** > button to access the [**Shooting mode**] screen shown here.

☆ to the right of titles indicates functions only available in [**P**], [**TV**], [**AV**], or [**M**] mode.

## ! Caution

- When switching from still photo shooting to movie recording, check the camera settings again before recording movies.

## 📄 Note

- You can record movies by pressing the movie shooting button during still photo shooting.
- Movies recorded in [**A+**] shooting mode are recorded with [**A+**] mode quality. Movies recorded in shooting modes other than [**A+**] are recorded with [**P**] mode quality.

- [Tab Menus: Movie Recording](#)
- [Movie Recording](#)
- [Movie Recording Quality](#)
- [Movie Cropping](#) ☆
- [Sound Recording](#)
- [Canon Log Settings](#) ☆
- [HDR Movie Recording](#)
- [Time-Lapse Movies](#)
- [Movie Self-Timer](#)
- [Image Stabilizer \(IS Mode\)](#)
- [Shutter Button Function for Movies](#)
- [Zebra Settings](#) ☆
- [Time Code](#)

- [Other Menu Functions](#)
- [General Movie Recording Precautions](#)

## Tab Menus: Movie Recording

### ● Shooting 1

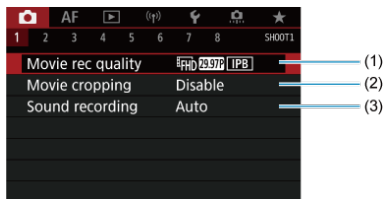

- (1) [Movie rec quality](#)
- (2) [Movie cropping](#) ☆
- (3) [Sound recording](#)

### ● Shooting 2

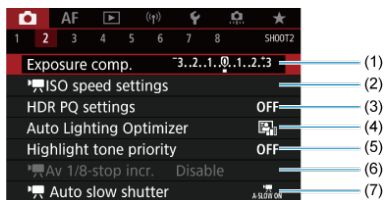

- (1) [Exposure comp.](#) ☆
- (2) [ISO speed settings](#) ☆
- (3) [HDR PQ settings](#) ☆
- (4) [Auto Lighting Optimizer](#) ☆
- (5) [Highlight tone priority](#) ☆
- (6) [Av 1/8-stop incr.](#) ☆
- (7) [Auto slow shutter](#) ☆



### ● Shooting 3



- (1) [White balance](#) ☆
- (2) [Custom White Balance](#) ☆
- (3) [WB correction](#) ☆
- (4) Picture Style
  - [Picture Style Selection](#) ☆
  - [Picture Style Customization](#) ☆
  - [Picture Style Registration](#) ☆
- (5) [Canon Log settings](#) ☆
- (6) [Clarity](#) ☆

### ● Shooting 4

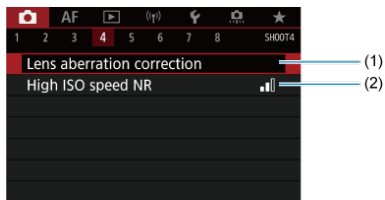

- (1) [Lens aberration correction](#) ☆
- (2) [High ISO speed NR](#) ☆

## ● Shooting 5

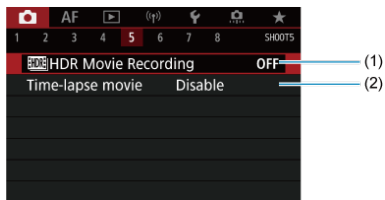

(1) [HDR Movie Recording](#)

(2) [Time-lapse movie](#)

## ● Shooting 6

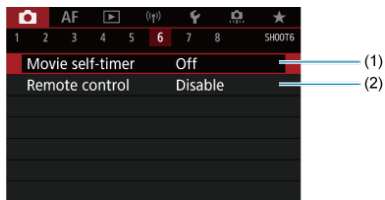

(1) [Movie self-timer](#)

(2) [Remote control](#)

## ● Shooting 7

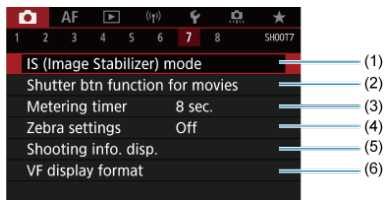

- (1) [IS \(Image Stabilizer\) mode](#)
- (2) [Shutter btn function for movies](#)
- (3) [Metering timer](#) ☆
- (4) [Zebra settings](#) ☆
- (5) [Shooting info. disp.](#) ☆
- (6) [VF display format](#) ☆

## ● Shooting 8

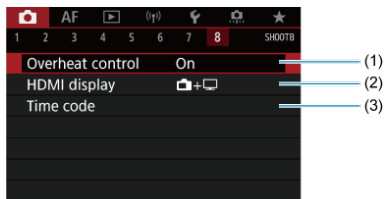

- (1) [Overheat control](#)
- (2) [HDMI display](#)
- (3) [Time code](#)

# Movie Recording



---

-  [Autoexposure Recording](#)
-  [Shutter-Priority AE](#)
-  [Aperture-Priority AE](#)
- [Scene Icons](#)
- [ISO Speed in \[!\[\]\(f51929fecf7b0dc947ac13f4c4835e8f\_img.jpg\)\]/\[!\[\]\(dfbf0e54bcca114319aa65c906feb8d0\_img.jpg\)\]/\[!\[\]\(64792950f1b7ee883a860b5f0af110c3\_img.jpg\)\]/\[!\[\]\(a4c91228d412dab12bd635819fc28c10\_img.jpg\)\] Mode](#)
-  [Manual Exposure Recording](#)
- [ISO Speed in \[!\[\]\(a8426952ff919f2600e76f3323526877\_img.jpg\)\] Mode](#)
- [Shutter Speed](#)
- [Still Photo Shooting](#)
- [Information Display \(Movie Recording\)](#)



## **Autoexposure Recording**

---

Exposure is controlled automatically to suit the brightness.

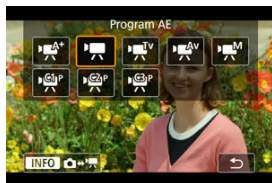
1. Set the recording mode to [] or [].



- Press the < **MODE** > button, then turn the <  > dial to select [] or [].

## 2. Focus on the subject.

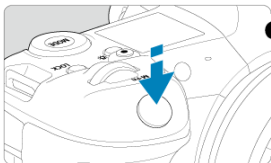

- Before recording a movie, focus with AF (☑) or manual focus (☑).
- By default, [**AF: Movie Servo AF**] is set to [**Enable**] so that the camera always keeps focusing (☑).
- When you press the shutter button halfway, the camera will focus with the current AF method.

### 3. Record the movie.

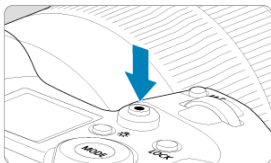

- Press the movie shooting button to start recording a movie. You can also start recording a movie by tapping [●] on the screen.



- While the movie is being recorded, the [●REC] icon (1) will be displayed in the upper right of the screen.

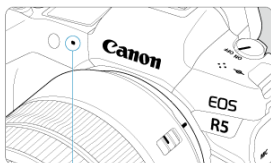



- Sound is recorded with the movie microphone (2).
- To stop recording the movie, press the movie shooting button again. You can also stop recording a movie by tapping [■] on the screen.

## Shutter-Priority AE

[] recording mode enables you to set your preferred shutter speed for movies. ISO speed and aperture values are set automatically to suit the brightness and obtain standard exposure.

### 1. Set the recording mode to [].



- Press the < **MODE** > button, then turn the <  > dial to select [].

### 2. Set the shutter speed (1).



(1)

- Set it by looking at the screen as you turn the <  > dial.
- The available shutter speeds vary depending on the frame rate.

### 3. Focus and record the movie.



- Same as steps 2 and 3 for [Autoexposure Recording](#).

#### ⚠ Caution

- Avoid adjusting shutter speed while recording movies, which will record changes in exposure.
- When recording a movie of a moving subject, a shutter speed of approx. 1/25 sec. to 1/125 sec. is recommended. The faster the shutter speed, the less smooth the subject's movement will look.
- If you change the shutter speed while recording under fluorescent or LED lighting, image flicker may be recorded.





## Aperture-Priority AE

[] recording mode enables you to set your preferred aperture value for movies. ISO speed and shutter speed are set automatically to suit the brightness and obtain standard exposure.

### 1. Set the recording mode to [].



- Press the <MODE> button, then turn the <> dial to select [].

### 2. Set the aperture value (1).



(1)

- Set it by looking at the screen as you turn the <> dial.

### 3. Focus and record the movie.







- Same as steps 2 and 3 for [Autoexposure Recording](#).

#### Caution

- Avoid adjusting the aperture value while recording movies, which will record changes in exposure caused by aperture adjustment.

#### Note

##### Notes for [M<sup>A</sup>], [P<sup>A</sup>], [M<sup>TV</sup>], and [M<sup>AV</sup>] modes

- You can lock the exposure (AE lock) by pressing the <  > button (except in [M<sup>A</sup>] mode). After applying AE lock during movie recording, you can cancel it by pressing the <  > button. (AE lock setting is retained until you press the <  > button.)
- Exposure compensation can be set in a range of up to ±3 stops by turning the <  > dial (except in [M<sup>A</sup>] mode).
- In [M<sup>A</sup>] and [P<sup>A</sup>] mode, the ISO speed, shutter speed, and aperture value are not recorded in movie Exif information.
- The camera is compatible with Speedlite functionality to activate the LED light automatically under low light when recording movies in [M<sup>A</sup>], [P<sup>A</sup>], [M<sup>TV</sup>], and [M<sup>AV</sup>] modes. For details, refer to the Instruction Manual of the EX series Speedlite equipped with an LED light.

## Scene Icons

---



In [A+] recording mode, the camera detects the type of scene and sets all settings accordingly. The detected scene type is indicated in the upper left of the screen. For icon details, see [Scene Icons](#).

## ISO Speed in [P<sup>A</sup>]/[P<sup>■</sup>]/[T<sup>V</sup>]/[P<sup>Av</sup>] Mode

---



ISO speed is set automatically. See [ISO Speed in Movie Recording](#).

## Manual Exposure Recording

You can manually set the shutter speed, aperture value, and ISO speed for movie recording.

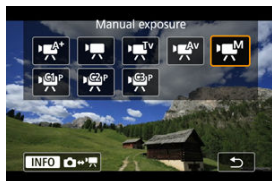
1. Set the recording mode to [].





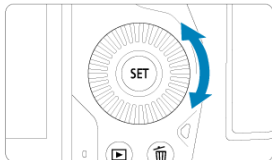
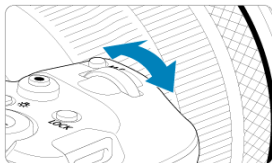

- Press the <MODE> button, then turn the < > dial to select [].

## 2. Set the shutter speed, aperture value, and ISO speed.



(1) (2) (3)

- Press the shutter button halfway and check the exposure level indicator.
- Turn the <  > dial to set the shutter speed (1), the <  > dial to set the aperture value (2), and the <  > dial to set the ISO speed (3).
- Available shutter speeds vary by frame rate ().

### 3. Focus and record the movie.

- Same as steps 2 and 3 for [Autoexposure Recording](#).

#### Caution

- ISO speed cannot be expanded to L (equivalent to ISO 50) in movie recording.
- During movie recording, avoid changing the shutter speed, aperture value, or ISO speed, which may record changes in the exposure or create more noise at high ISO speeds.
- When recording a movie of a moving subject, a shutter speed of approx. 1/25 sec. to 1/125 sec. is recommended. The faster the shutter speed, the less smooth the subject's movement will look.
- If you change the shutter speed while recording under fluorescent or LED lighting, image flicker may be recorded.

#### Note

- Exposure compensation with ISO Auto can be set in a range of  $\pm 3$  stops.
- When ISO Auto is set, you can press the  $\langle \star \rangle$  button to lock the ISO speed. After locking the ISO speed during movie recording, you can cancel it by pressing the  $\langle \text{ISO} \rangle$  button. (ISO speed lock is maintained until you press the  $\langle \text{ISO} \rangle$  button.)
- If you press the  $\langle \star \rangle$  button and recompose the shot, you can see the exposure level difference on the exposure level indicator () compared to when the  $\langle \star \rangle$  button was pressed.

## ISO Speed in [M] Mode

---

You can set the ISO speed manually or select [AUTO] to set it automatically. For details on ISO speed, see [ISO Speed in Movie Recording](#).



## Shutter Speed

Available shutter speeds in [i] and [M] mode vary depending on the frame rate of your specified movie recording quality.

Frame Rate	Shutter Speed (Sec.)		
	Normal Movie Recording	High Frame Rate Movie Recording	HDR Movie Recording
119.9P	-	1/4000-1/125	-
100.0P		1/4000-1/100	
59.94P	1/4000-1/8	-	-
50.00P			
29.97P			
25.00P			[i] 1/4000-1/50 [M] 1/1000-1/50
24.00P			-
23.98P			

## Still Photo Shooting

---



**Still photo shooting is not supported in movie recording mode.** To shoot still photos, stop recording and change the [**Shooting mode**] setting to still photos first.

## Information Display (Movie Recording)

---

For details on the icons on the movie recording screen, see [Information Display](#).

### Caution

- The remaining time displayed for movie recording is only a guideline.
- Movie recording may stop before the initially displayed recording time elapses if the red  icon appears due to high internal camera temperature during recording ().

## Movie Recording Quality



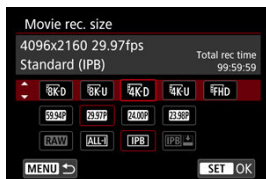

---

- [Movie Recording Size](#)
- [8K/4K Movie Recording](#)
- [Image Area](#)
- [Cards That Can Record Movies](#)
- [High Frame Rate](#)
- [4K HQ Mode](#)
- [Movie Files Exceeding 4 GB](#)
- [Total Movie Recording Time and File Size Per Minute](#)
- [Movie Recording Time Limit](#)



You can set the image size, frame rate, and compression method in the **[Movie rec. size]** menu of **[CAM: Movie rec quality]**. The frame rate displayed on the **[Movie rec. size]** screen switches automatically depending on the **[Video system]** setting (🔧).



## Movie Recording Size

	Image size	Aspect Ratio
	8192×4320	17:9
	7680×4320	16:9
	4096×2160	17:9
	3840×2160	16:9
	1920×1080	16:9

### Caution



- If you change the [: **Video system**] setting, also set [: **Movie rec quality**] again.
- Other devices may not play movies such as 8K, 4K, , or High Frame Rate movies normally, because playback is processing-intensive.
- Apparent resolution and noise vary slightly depending on movie recording quality, cropped shooting settings, and the lens used.

### Note

- To obtain better performance with the card, formatting the card with the camera before recording movies is recommended ().
- Movies cannot be recorded in HD or VGA quality.

## 8K/4K Movie Recording

---

- Recording 8K or 4K movies requires a stable card with a fast writing speed. For details, see [Cards That Can Record Movies](#).
- 8K/4K or High Frame Rate movie recording greatly increases the processing load, which may increase the internal camera temperature faster or higher than for regular movies. **If  or a red  icon appears during movie recording, the card may be hot, so stop recording the movie and let the camera cool down before removing the card. (Do not remove the card immediately.)**
- From a 8K or 4K movie, you can select any frame to save to the card as a JPEG still image (.
- HDMI video output of 8K movies results in 4K movies.

## Image Area

The movie image area varies depending on factors such as movie recording quality and cropped shooting settings and the lens used.

- RF or EF lenses: With : **Movie cropping** set to **[Disable]**

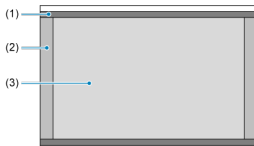

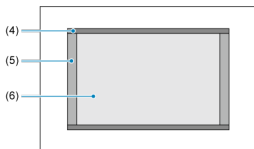

- (1) 8K-U (time-lapse) / 4K-U (time-lapse) / FHD (time-lapse)
- (2) 8K-D (8192×4320) / 4K-D (4096×2160)
- (3) 8K-U (7680×4320) / 4K-U (3840×2160) / FHD (1920×1080)

- RF or EF lenses: With : **Movie cropping** set to **[Enable]**
- EF-S lenses



- (4) 4K-U (time-lapse) / FHD (time-lapse)
- (5) 4K-D (4096×2160)
- (6) 4K-U (3840×2160) / FHD (1920×1080)

### Caution

- Recording of 8K, 4K, and High Frame Rate movies is not supported with EF-S lenses, or with : **Movie cropping** set to **[Enable]**.
- Recording with Movie digital IS  further crops the image around the center of the screen.

## Frame rate (fps: frames per second)

- **[119.9P] 119.9 fps/[59.94P] 59.94 fps/[29.97P] 29.97 fps**  
For areas where the TV system is NTSC (North America, Japan, South Korea, Mexico, etc.). For [119.9P], see [High Frame Rate](#).
- **[100.0P] 100.00 fps/[50.00P] 50.00 fps/[25.00P] 25.00 fps**  
For areas where the TV system is PAL (Europe, Russia, China, Australia, etc.). For [100.0P], see [High Frame Rate](#).
- **[24.00P] 24.00 fps/[23.98P] 23.98 fps**  
Mainly for cinematic purposes. **23.98P** (23.98 fps) is available when [🔊: Video system] is set to [For NTSC].

## Compression method

- **[ALL-I] ALL-I** (For editing/I-only)  
Compresses each frame, one at a time, for recording. Although file sizes are larger than with IPB (Standard), movies are more suitable for editing.
- **[IPB] IPB** (Standard)  
Compresses multiple frames at a time efficiently for recording. File sizes are smaller than with ALL-I (For editing), which enables movie recording over longer periods (with a card of the same capacity).
- **[IPB] IPB** (Light)  
Since the movie is recorded at a bit rate lower than with IPB (Standard), the file size will be smaller than with IPB (Standard) and the playback compatibility will be higher. This will make the available recording time longer than with IPB (Standard) (with a card having the same capacity).

## Movie recording format

- **[RAW] RAW**  
When [RAW] is selected, movies are recorded as RAW movie files (file extension “.CRM”).
- **[MP4] MP4**  
When [ALL-I], [IPB], or [IPB] IPB is selected, movies are recorded as MP4 movie files (file extension “.MP4”).



## RAW movies

RAW movies are raw, unprocessed data from the image sensor that are recorded to the card digitally.

You can use Digital Photo Professional (EOS software) to process RAW movies. You can make various adjustments to images depending upon how they will be used and can generate JPEG, HEIF, or other types of images reflecting the effects of those adjustments.

### Caution

- RAW movies cannot be processed using : **RAW processing (RAW/DPRAW)**.

### Note

- To display RAW movies on a computer, using Digital Photo Professional (EOS software, hereafter DPP) is recommended.
- Older versions of DPP Ver. 4.x do not support display, processing, editing, or other operations with RAW movies recorded by this camera. If a previous version of DPP Ver. 4.x is installed on your computer, obtain and install the latest version of DPP from the Canon website to update it , which will overwrite the previous version. Similarly, DPP Ver. 3.x or earlier does not support display, processing, editing, or other operations with RAW movies recorded by this camera.
- Commercially available software may not be able to display RAW movies recorded by this camera. For compatibility information, contact the software manufacturer.
- To prioritize gradation in highlights, set Canon Log to **[On]**. This is recommended for Cinema EOS and RAW movies.

## Cards That Can Record Movies

For details on CFexpress cards that can record at each level of movie recording quality, check the Canon website.

See [Card performance requirements](#) for details on SD cards.

**Test cards by recording a few movies to make sure they can record correctly at your specified size (🔗).**

### Caution

- Before recording 8K or 4K movies, format cards by selecting [**Low level format**] in [**Format card**] (🔗).
- If you use a slow-writing card when recording movies, the movie may not be recorded properly. Also, if you play back a movie on a card with a slow reading speed, the movie may not be played back properly.
- When recording movies, use high-performance cards with a writing speed sufficiently higher than the bit rate.
- When movies cannot be recorded properly, format the card and try again. If formatting the card does not resolve the problem, refer to the card manufacturer's website, etc.

### Unsupported movie recording

- The following files cannot be recorded to SD cards. Pressing the movie shooting button will not start recording.
  - RAW movies
  - 8K ALL-I
  - 4K 119.9/100.0 fps (High Frame Rate movies)
  - 4K ALL-I HEVC (YUV422, 10-bit)
  - 4K 59.94/50.00 fps ALL-I H.264 (YUV420, 8-bit)

### Note

- To obtain better performance with the card, formatting the card with the camera before recording movies is recommended (🔗).
- To check the card's writing/reading speed, refer to the card manufacturer's website, etc.

## High Frame Rate

You can record 4K movies at a high frame rate of 119.9 fps or 100.0 fps. This is ideal for recording movies that will be played back in slow motion. The maximum recording time per movie is 7 min. 29 sec.

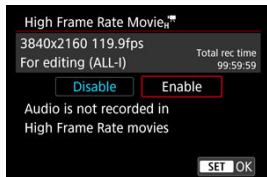

- Movies are recorded in  $\overline{4K-D} \overline{119.9P} \overline{[ALL-I]}$  /  $\overline{4K-U} \overline{119.9P} \overline{[ALL-I]}$  or  $\overline{4K-D} \overline{100.0P} \overline{[ALL-I]}$  /  $\overline{4K-U} \overline{100.0P} \overline{[ALL-I]}$  quality.
- Sound is not recorded in High Frame Rate movies.
- Time code display during movie recording advances 4 sec. per second.
- Because High Frame Rate movies are recorded as 29.97 fps/25.00 fps movie files, they are played in slow motion at 1/4 speed.

### ! Caution

#### Precautions when set to [High Frame Rate: Enable]

- Time codes are not recorded when [Count up] is set to [Free run] in [📷: Time code] (🔒).
- Check the [Movie rec. size] setting if you return this setting to [Disable].
- The screen may flicker if you record High Frame Rate movies under fluorescent or LED lighting.
- For a moment when you start or stop recording High Frame Rate movies, the movie is not updated, and the frame stops momentarily. Be aware of this when recording movies to external devices via HDMI.
- Movie frame rates shown on the screen as you record High Frame Rate movies do not correspond to the frame rate of the movie recorded.
- Headphones cannot be used (no sound is audible).
- ISO speed can be set within ISO 100–12800. Note that ISO expansion is not available.
- The frame rate of HDMI video output is 59.94 fps or 50.00 fps.

## 4K HQ Mode

You can record movies at a higher level of quality than normal 4K movies.

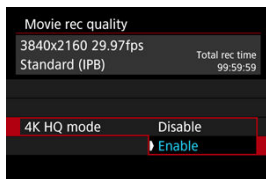

- Movie recording sizes for 4K HQ mode are displayed.

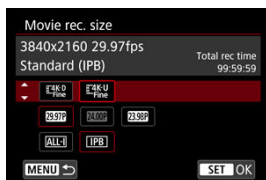

## Movie Files Exceeding 4 GB

- **Using SD/SDHC cards formatted with the camera**

If you use the camera to format an SD/SDHC card, the camera will format it in FAT32. With a FAT32-formatted card, if you record a movie and the file size exceeds 4 GB, a new movie file will be created automatically.

When you play back the movie, you will have to play back each movie file individually. Movie files cannot be played back automatically in consecutive order. After the movie playback ends, select the next movie and play it back.

- **Using SDXC cards formatted with the camera**

If you use the camera to format an SDXC card, the camera will format it in exFAT.

When using an exFAT-formatted card, even if the file size exceeds 4 GB during movie recording, the movie will be saved as a single file (rather than being split into multiple files).

### Caution

- When importing movie files exceeding 4 GB to a computer, use either EOS Utility or a card reader (🔗). It may not be possible to save movie files exceeding 4 GB if you attempt this using standard features of the computer's operating system.

## Total Movie Recording Time and File Size Per Minute

---

For details, see [Movie recording](#).

## Movie Recording Time Limit

---

- **When recording non-High Frame Rate movies**

The maximum recording time per movie is 29 min. 59 sec. Once 29 min. 59 sec. is reached, recording automatically stops. You can start recording a movie again by pressing the movie shooting button (which records the movie as a new file).

- **When recording High Frame Rate movies**

The maximum recording time per movie is 7 min. 29 sec. Once 7 min. 29 sec. is reached, recording automatically stops. You can start recording a High Frame Rate movie again by pressing the movie shooting button (which records the movie as a new file).

 **Caution**

- The camera's internal temperature may rise and less recording time may be available after extended movie playback or Live View display.

With RF or EF lenses, movies can be cropped around the center of the image, as if using a telephoto lens.

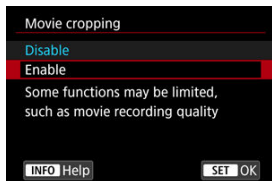

Recording movies with EF-S lenses has the same effect as this movie cropping feature.

1. Select [: Movie cropping].



2. Select [Enable].

## Caution

- 8K, High Frame Rate, and 4K HQ movies cannot be recorded with movie cropping.
- The center of the screen is further cropped, reducing the recording area, when [ Digital IS] in [ IS (Image Stabilizer) mode] is set to [On] or [Enhanced].

## Note

- The recording area available with movie cropping is the same as when recording movies with EF-S lenses.
- For details on the recording area, see [Image Area](#).



## Sound Recording

[Sound Recording/Sound-Recording Level](#)

[Wind Filter](#)

[Attenuator](#)

You can record movies while recording sound with the built-in monaural microphone or an external stereo microphone. You can also freely adjust the sound-recording level.

Use **[CAMERA]: Sound recording** to set sound recording functions.

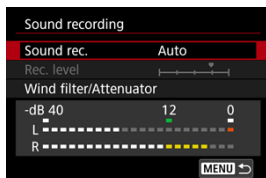

### Caution

- Sounds from Wi-Fi operations may be captured with built-in or external microphones. During sound recording, using the wireless communication function is not recommended.
- When connecting an external microphone or headphones to the camera, be sure to insert the plug all the way in.
- The camera's built-in microphone may also record mechanical sounds of the lens or sounds of camera/lens operations if AF operations are performed or the camera or lens is operated during movie recording. In this case, using an external microphone may reduce these sounds. If the sounds are still distracting with an external microphone, it may be more effective to remove the external microphone from the camera and position it away from the camera and lens.
- Do not connect anything other than an external microphone to the camera's external microphone IN terminal.
- Noise reduction is not applied to the audio played through headphones. Thus, the audio recorded with the movie will be different.
- Do not change the **[CAMERA]: Sound recording** settings when listening with headphones. This may cause sudden loud output that may hurt your ears.

#### Note

- In [P/A] mode, the settings available for [📷: Sound recording] are [On] or [Off]. Set to [On] for automatic adjustment of the recording level.
- Audio is also output when the camera is connected to televisions via HDMI, except when [Sound rec.] is set to [Disable]. In case of feedback from television audio output, move the camera away from the television or turn down the volume.
- The volume balance between L/R (left/right) cannot be adjusted.
- Sound is recorded at a 48 kHz/16-bit sampling rate.

---

## Sound Recording/Sound-Recording Level

---

### ● Auto

The sound-recording level is adjusted automatically. Auto level control will take effect automatically in response to the sound level.

### ● Manual

You can adjust the sound-recording level as needed. Select [Rec. level] and turn the <  > dial while looking at the level meter to adjust the sound-recording level. Look at the peak hold indicator, and adjust so that the level meter sometimes lights up on the right of the "12" (-12 dB) mark for the loudest sounds. If it exceeds "0", the sound will be distorted.

### ● Disable

Sound will not be recorded.

## Wind Filter

---

Set to **[Enable]** to reduce wind noise when there is wind outdoors. Only activated when the camera's built-in microphone is used. When the wind filter function takes effect, part of the low bass sounds will also be reduced.

## Attenuator

---

Automatically suppresses sound distortion caused by loud noises. Even if **[Sound rec.]** is set to **[Auto]** or **[Manual]** for recording, sound distortion may still result if there is a very loud sound. In this case, setting it to **[Enable]** is recommended.

- **Microphone**

Normally, the built-in microphone records in mono.

Any external microphones with a 3.5 mm mini-jack connected to the camera's external microphone IN terminal (🔊), are used instead. Using Directional Stereo Microphone DM-E1 (sold separately) is recommended.

- **Headphones**

By connecting commercially available headphones with a 3.5 mm mini-jack to the headphone terminal (🎧), you can listen to the sound as movies are recorded. To adjust headphone volume, press the <Q> button, select [🔊], and adjust by turning the

<🔊> or <🔊> dial or press <🌟> left or right (🔊).

You can also use headphones during movie playback.

[Shooting Settings](#)

[Canon Log Image Quality](#)

Canon Log gamma curve takes full advantage of image sensor characteristics to ensure wide dynamic range for movies that will be processed in postproduction. With minimal loss of detail in shadows and highlights, movies retain more visual information across the dynamic range.

To work with Canon Log movies in postproduction, you can apply look-up tables (LUTs). LUT data can be downloaded from the Canon website.

---

## 1. Select [CAMERA]: Canon Log settings].

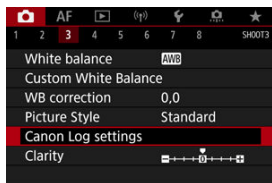

## 2. Select [Canon Log].

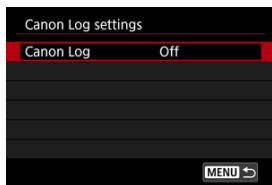

3. Select [On] (🔍).

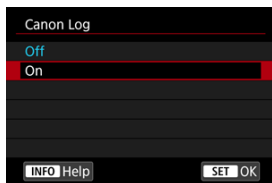

4. Set the options as desired.

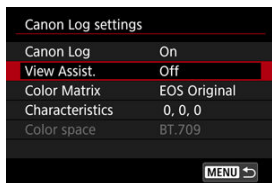

- Set [\[View Assist.\]](#), [\[Color Matrix\]](#), [\[Characteristics\]](#), and [\[Color space\]](#).

## Canon Log

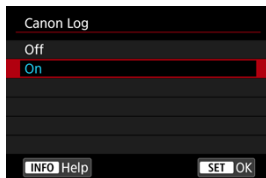

- **On**

Enables 10-bit recording of Canon Log movies to the card. Movies can also be recorded to an external device that supports 10-bit recording.

 **Note**

- YCbCr 4:2:2 (10-bit) color sampling and the BT.709/BT.2020 color space are used in Canon Log recording.

## View Assist.

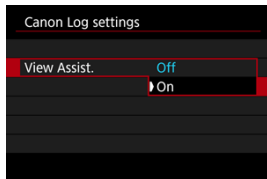

When played on the camera, these movies may look darker and have lower contrast than movies recorded with a Picture Style applied, due to Canon Log image characteristics, which are intended to ensure a wide dynamic range. For clearer display that makes it easier to check details, set **[View Assist.]** to **[On]**.

- Setting this feature to **[On]** does not affect movies recorded to the card, which are recorded using Canon Log characteristics. Similarly, HDMI video output has Canon Log characteristics, and View Assist is not used for it.

### Note

- **[V.Assist]** is shown on the information display screen during movie recording with View Assist.
- When set to **[On]**, View Assist is also used with magnified display.

## Color Matrix

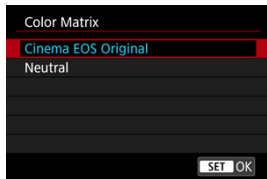

Using a color matrix, you can specify how colors are reproduced, to plan for postproduction processing.

- **Cinema EOS Original**  
Reproduces colors equivalent to those of the EOS-1D C.
- **Neutral**  
Reproduces colors similar to actual subject colors.



## Characteristics

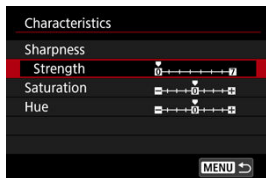

Adjust as needed. Select an option ([**Sharpness: Strength**], [**Saturation**], or [**Hue**]), adjust the effect level, then press < (SET) >.

<b>Sharpness: Strength</b>		0: Weak outline emphasis	7: Strong outline emphasis
<b>Saturation</b>		-4: Low	+4: High
<b>Hue*</b>	<b>Reds</b>	-4: Toward magenta	+4: Toward yellow
	<b>Greens</b>	-4: Toward yellow	+4: Toward cyan
	<b>Blues</b>	-4: Toward cyan	+4: Toward magenta

\* Reds, greens, and blues cannot be adjusted separately.

## Color space

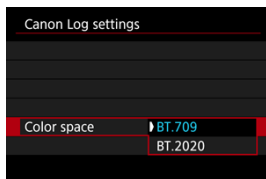

[**Color space**] can be set when [**Canon Log**] is set to [**On**] and [**Color Matrix**] to [**Neutral**]. Choose [**BT.709**] or [**BT.2020**] as the color space for HDMI output.

## Shooting Settings

---

- Manually setting the ISO speed to 100–320 will make the dynamic range narrower.
- Canon Log offers a dynamic range of approx. 800% at ISO 400 or higher.
- ISO 100, 125, 160, 200, 250, and 320 are expanded ISO speeds. [L] is displayed when an ISO speed is set.

## Canon Log Image Quality

- With Canon Log, movies may be affected by horizontal banding, depending on the subject or shooting conditions. Record a few test movies and check the results in advance. In particular, noise may become more noticeable if you enhance the contrast when color-grading your movies.
- With Canon Log, skies, white walls, and similar subjects may be affected by noise or uneven gradation, exposure, or colors.
- Horizontal banding is more likely to occur when recording somewhat dark, flat subjects. This image noise may even occur at relatively low ISO speeds around ISO 400.
- If noise is noticeable, try recording under brighter conditions and adjusting brightness in color grading. Noise can also be reduced by recording at ISO speeds lower than ISO 400, although dynamic range is narrower.

### Caution

#### General Canon Log shooting precautions

- With Canon Log, autofocusing may be more difficult for subjects under low light, or for low-contrast subjects.
- Noise may appear at image edges if **[Peripheral illum corr]** in  **Lens aberration correction** is set to **[Enable]** when Canon Log is set.
- Canon Log 2 and Canon Log 3 are not supported.
- Histograms of images captured with **[Canon Log]** set to **[On]** are not based on images as converted for View Assist display. Image areas shown in gray in the histogram roughly indicate signal values that are not used.
- ISO 100–320 is not available when recording RAW movies with Canon Log set.

### Note

#### Playing movies recorded with Canon Log

- View Assist is not used during movie playback.

# HDR Movie Recording

---

You can record high dynamic range movies that retain detail in highlights of high-contrast scenes.

---

1. Select [ HDR] HDR Movie Recording].

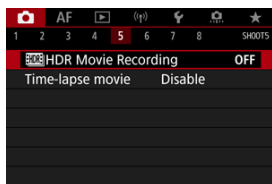







- Select [**Enable**].

2. Record an HDR movie.

- Record the movie in the same way as normal movie recording.
- For details on file sizes and the recording time available, see [Movie recording](#).

## Caution

- HDR movie recording is not available with [: **IS (Image Stabilizer) mode**] set to [ **Digital IS**], or when set to [: **Time-lapse movie**], [: **Highlight tone priority**], [: **Canon Log settings**], or [: **HDR PQ settings**].
- Since multiple frames are merged to create an HDR movie, certain parts of the movie may look distorted. This is more noticeable in handheld recording affected by camera shake, so consider using a tripod. Note that even if a tripod is used for recording, afterimages or noise may become more noticeable, compared to normal playback, when the HDR movie is played back frame-by-frame or in slow motion.
- Image color and brightness may change significantly for a moment if you change settings for HDR movie recording. Also, the movie will not be updated for a moment, and the frame stops momentarily. Be aware of this when recording movies to external devices via HDMI.

## Note



- The recording size is  $\overline{\text{FHD}}\overline{29.97\text{P}}\overline{\text{IPB}}$  (NTSC) or  $\overline{\text{FHD}}\overline{25.00\text{P}}\overline{\text{IPB}}$  (PAL).

# Time-Lapse Movies

## [Approx. Time Available for Recording Time-Lapse Movies](#)

Still photos captured at your specified interval can be automatically combined to create an 8K, 4K, or Full HD time-lapse movie. A time-lapse movie shows how a subject changes in a much shorter period of time than the actual time it took. It is effective for a fixed-point observation of changing scenery, growing plants, celestial motion, etc.

**Time-lapse movies are recorded in MP4 format at the following quality:**  $\overline{8K-U29.97P}$  [ALL-I] (NTSC) /  $\overline{8K-U25.00P}$  [ALL-I] (PAL) in 8K recording,  $\overline{4K-U29.97P}$  [ALL-I] (NTSC) /  $\overline{4K-U25.00P}$  [ALL-I] (PAL) in 4K recording, and  $\overline{FHD29.97P}$  [ALL-I] (NTSC) /  $\overline{FHD25.00P}$  [ALL-I] (PAL) in Full HD recording.

Note that the frame rate is updated automatically to match the [: Video system] setting ().

1. Select [: Time-lapse movie].



2. Select [Time-lapse].



- Select [Enable].

### 3. Set [Interval].



(1)

(2)

- Select [Interval].
- As you set the number, refer to the [🔊] time required (1) and [▶] playback time (2).
- Select an option (hours : minutes : seconds).
- Press <ⓈET> to display [↕].
- Set the desired number, then press <ⓈET>. (Returns to [□].)
- Can be set in a range of [00:00:02]–[99:59:59]. (An interval of once per second is not available.)
- Select [OK] to register the setting.

## 4. Set [No. of shots].

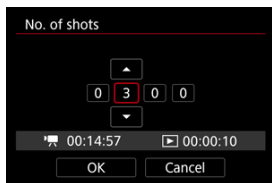

- Select **[No. of shots]**.
- As you set the number, refer to the time required ([]) and playback time ([]).
- Select the digit.
- Press < > to display [].
- Set the desired number, then press < >. (Returns to [].)
- Can be set in a range of [0002]–[3600].
- Make sure the playback time ([]) is not displayed in red.
- Select **[OK]** to register the setting.
- The playback time ([]) is displayed in red if the card does not have enough free space to record the specified number of shots. Although the camera can continue recording, the recording will stop when the card becomes full.
- Playback time ([]) is displayed in red if the **[No. of shots]** setting results in a file size exceeding 4 GB for a card not formatted in exFAT (). If you keep recording in this condition and the movie file size reaches 4 GB, the time-lapse movie recording will stop.



### Note

- For details on cards that can record time-lapse movies (card performance requirements), see [Card performance requirements](#).
- If the number of shots is set to 3600, the time-lapse movie will be approx. 2 min. in NTSC and approx. 2 min. 24 sec. in PAL.



## 5. Select [Movie rec. size].



- **8K-U (7680×4320)**  
The movie is recorded in 8K quality. The aspect ratio is 16:9. Additionally, the frame rate is 29.97 fps (**29.97P**) for NTSC and 25.00 fps (**25.00P**) for PAL, and movies are recorded in MP4 (**MP4**) format with ALL-I (**ALL-I**) compression.
- **4K-U (3840×2160)**  
The movie is recorded in 4K quality. The aspect ratio is 16:9. Additionally, the frame rate is 29.97 fps (**29.97P**) for NTSC and 25.00 fps (**25.00P**) for PAL, and movies are recorded in MP4 (**MP4**) format with ALL-I (**ALL-I**) compression.
- **FHD (1920×1080)**  
The movie will be recorded in Full High-Definition (Full HD) quality. The aspect ratio is 16:9. Additionally, the frame rate is 29.97 fps (**29.97P**) for NTSC and 25.00 fps (**25.00P**) for PAL, and movies are recorded in MP4 (**MP4**) format with ALL-I (**ALL-I**) compression.

## 6. Set [Auto exposure].



- **Fixed 1st frame**

When taking the first shot, metering is performed to set the exposure automatically to match the brightness. The exposure setting for the first shot will be applied to subsequent shots. Other shooting-related settings for the first shot will also be applied for subsequent shots.

- **Each frame**

Metering is also performed for each subsequent shot to set the exposure automatically to match the brightness. Note that any functions such as Picture Style and white balance that are set to **[Auto]** will be set automatically for each subsequent shot.

 **Caution**

- Significant changes in brightness between shots may prevent the camera from shooting at the specified interval when **[Interval]** is set to less than 3 sec. and **[Auto exposure]** is set to **[Each frame]**.

## 7. Set [Screen auto off].

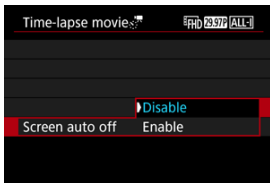

- **Disable**

Even during time-lapse movie recording, the image will be displayed. (The screen turns off only at the time of shooting.) Note that the screen will turn off when approx. 30 min. elapse after the shooting started.

- **Enable**

Note that the screen will turn off when approx. 10 sec. elapse after the shooting started.

### Caution

- Even if **[Screen auto off]** is set to **[Disable]**, the screen turns off during exposure. Also note that images may not be displayed if the interval between shots is too brief.

### Note

- During time-lapse movie recording, you can press the < **INFO** > button to turn on/off the screen.

## 8. Set [Beep as img taken].

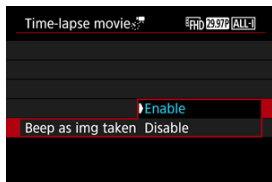

- Set to [Disable] to prevent the camera from beeping for each shot.

## 9. Check the settings.



(1)

(2)

- **Time required (1)**  
Indicates the time required to shoot the set number of shots with the set interval. If it exceeds 24 hours, "\*\*\*\* days" will be displayed.
- **Playback time (2)**  
Indicates the movie recording time (equivalent to the time required for playback) once the movie is created from still photos taken at regular intervals.

## 10. Close the menu.

- Press the <MENU> button to turn off the menu screen.

## 11. Read the message.

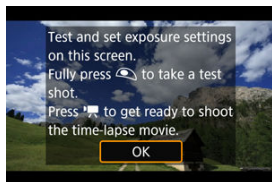

- Read the message and select [OK].

## 12. Take a test shot.

- As in still photo shooting, set the exposure and shooting functions, then press the shutter button halfway to focus.
- Press the shutter button completely to take a test shot, which is recorded to the card as a still photo.
- If there are no problems with the test shot, go to the next step.
- To take more test shots, repeat this step.

### Note

- Test shots are captured in JPEG quality.
- In [P/TV] or [P/M] mode, you can set the shutter speed in a range of 1/4000 to 30 sec.
- You can set the maximum limit for Auto ISO in [P/TV], [P/TV], and [P/Av] mode or in [P/M] mode with ISO Auto, in the [Menu] Max for Auto option of [Camera] ISO speed settings .
- If you have set [Half-press] in [Camera] Shutter btn function for movies to [Meter.+P/Servo AF], it is automatically changed to [Meter.+One-Shot AF] when you set up time-lapse movie recording.

**13. Press the movie shooting button.**

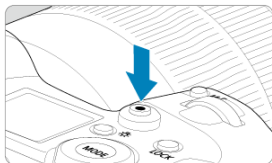

- The camera is now ready to start recording a time-lapse movie.
- To return to step 12, press the movie shooting button again.

## 14. Record the time-lapse movie.



- Press the < INFO > button and double-check the Time required (1) and Interval (2) shown on the screen.

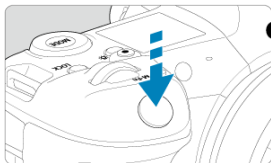

- Press the shutter button completely to start recording the time-lapse movie.
- AF will not work during time-lapse movie recording.
- A recording icon "●" is displayed on the screen as the time-lapse movie is recorded.
- When the set number of shots are taken, the time-lapse movie recording ends.
- To cancel recording time-lapse movies, set [Time-lapse] to [Disable].

 **Note**

- Using a tripod is recommended.
- Taking test shots as in step 12 and recording test movies for time-lapse movies beforehand is recommended.
- Field of view (coverage) for recording 8K, 4K, and Full HD time-lapse movies is approx. 100%.
- To cancel time-lapse movie recording in progress, either press the shutter button completely or press the movie shooting button. The time-lapse movie shot so far will be recorded on the card.
- If the time required for recording is more than 24 hours but not more than 48 hours, "2 days" will be indicated. If three or more days are required, the number of days will be indicated in 24-hour increments.
- Even if the time-lapse movie's playback time is less than 1 sec., a movie file will still be created. In this case, "00'00"" is indicated in **[Playback time]**.
- If the recording time is long, using the household power outlet accessories (sold separately) is recommended.
- YCbCr 4:2:0 (8-bit) color sampling and the BT.709 color space are used for 8K/4K/ Full HD time-lapse movies.



## Caution

- Do not point the camera toward an intense light source, such as the sun or an intense artificial light source. Doing so may damage the image sensor or the camera's internal components.
- Time-lapse movies cannot be recorded when the camera is connected to a computer with the interface cable, or when an HDMI cable is connected.
- Movie Servo AF will not function.
- For time-lapse movies in [M] mode, aperture is fixed and exposure is controlled using ISO speed.
- If the shutter speed is 1/30 sec. or slower, the exposure of the movie may not be displayed properly (may differ from that of the resulting movie).
- Do not zoom the lens during time-lapse movie recording. Zooming the lens may cause the image to be out of focus, the exposure to change, or the lens aberration correction not to function properly.
- Recording time-lapse movies under flickering light may cause noticeable screen flickering, and images may be captured with horizontal stripes (noise) or irregular exposure.
- Images displayed as time-lapse movies are recorded may look different from the resulting movie (in details such as inconsistent brightness from flickering light sources, or noise from a high ISO speed).
- When recording a time-lapse movie under low light, the image displayed during shooting may look different from what is actually recorded in the movie. In such cases, the [Exp.SIM] icon will blink.
- If you move the camera from left to right (panning) or shoot a moving subject during time-lapse movie recording, the image may look extremely distorted.
- During time-lapse movie recording, auto power off will not take effect. Also, you cannot adjust the shooting function and menu function settings, play back images, etc.
- No sound or time codes are recorded for time-lapse movies.
- To start or stop time-lapse movie recording, you can press the shutter button completely, regardless of the [Shutter btn function for movies] setting.
- Significant changes in brightness between shots may prevent the camera from shooting at the specified interval when [Interval] is set to less than 3 sec. and [Auto exposure] is set to [Each frame].
- If the shutter speed exceeds the shooting interval (such as for long exposures), or if a slow shutter speed is set automatically, the camera may not be able to shoot at the set interval. Shooting may also be prevented by shooting intervals nearly the same as the shutter speed.
- If the next scheduled shot is not possible, it will be skipped. This may shorten the recording time of the created time-lapse movie.
- If the time it takes to record to the card exceeds the shooting interval due to the shooting functions set or card performance, some of the shots may not be taken with the set intervals.
- The captured images are not recorded as still photos. Even if you cancel the time-lapse movie recording after only one shot is taken, it will be recorded as a movie file.

- Set [: **Time-lapse movie**] to [**Disable**] if you will connect the camera to a computer with the interface cable and use EOS Utility (EOS software). Options other than [**Disable**] will prevent the camera from communicating with the computer.
- Image stabilization is not applied in time-lapse movie recording.
- Time-lapse movie shooting ends if the power switch is set to < **OFF** >, for example, and the setting is changed to [**Disable**].
- Even if a flash is used, it will not fire.
- The following operations cancel standby for time-lapse movie recording and switch the setting to [**Disable**].
  - Selecting either [**Clean now** ] in [: **Sensor cleaning**] or [**Basic settings**] in [**Reset camera**]
- Image quality may be lower if you start time-lapse movie recording while the white [] temperature warning icon () is displayed. It is recommended that you start time-lapse movie recording after the white [] icon disappears (camera's internal temperature decreases).
- With [**Auto exposure**] set to [**Each frame**], the ISO speed, shutter speed, and aperture value may not be recorded in the time-lapse movie Exif information in some shooting modes.

#### Note

- You can use Wireless Remote Control BR-E1 (sold separately) to start and stop time-lapse movie recording.

#### With Wireless Remote Control BR-E1

- First, pair Wireless Remote Control BR-E1 with the camera ()
- Set [: **Remote control**] to [**Enable**].
- After you take some test shots and the camera is ready to shoot (as in step 13, ) , set the release timing/movie shooting switch on the BR-E1 to < > (immediate release) or < 2 > (2-sec. delay).
- If the remote control's switch has been set to < >, the time-lapse movie recording cannot start.

Camera Status/Remote Control Setting	<  > Immediate Release < 2 > 2-sec. Delay	<  > Movie Recording
Test-recording screen	Test recording	To recording standby
Recording standby	Starts recording	To test-recording screen
During time-lapse movie recording	Ends recording	Ends recording

## Approx. Time Available for Recording Time-Lapse Movies

---

For guidelines on how long you can record time-lapse movies (until the battery runs out), see [Movie recording](#).

# Movie Self-Timer

---

Movie recording can be started by the self-timer.

---

1. Select [📷: Movie self-timer].

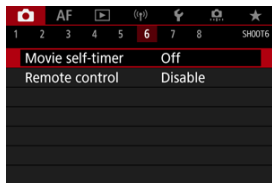

2. Select an option.

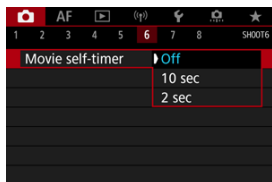

3. Record the movie.

- After you press the movie button or tap [●], the camera displays the number of seconds left before recording and beeps.

## Note

- To cancel the self-timer, either tap the screen or press < (SET) >.

## Image Stabilizer (IS Mode)

---

 [IS Mode](#)

 [Movie Digital IS](#)

The camera's IS mode and movie digital IS features reduce camera shake as movies are recorded. They can provide effective stabilization even when your lens is not equipped with Image Stabilizer. When using a lens equipped with Image Stabilizer, set the lens's Image Stabilizer switch to <ON>.

---

### IS Mode

---

1. Select [: IS (Image Stabilizer) mode].

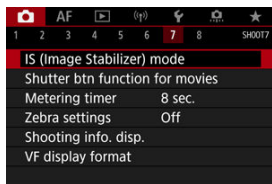

2. Select [IS mode].

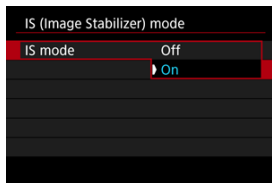

- Select [On].

 Caution

- [IS mode] is not displayed when an IS-equipped lens is attached.

1. Select [📷: IS (Image Stabilizer) mode].

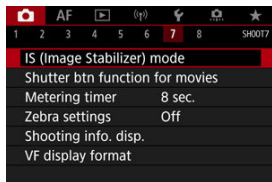

2. Select a [📷 Digital IS] option.

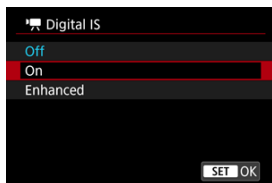

- **Off** (📷 OFF)  
Image stabilization with Movie digital IS is disabled.
- **On** (📷 ON)  
Camera shake will be corrected. The image will be slightly magnified.
- **Enhanced** (📷 ENH)  
Compared to when [On] is set, stronger camera shake can be corrected. The image will be more magnified.

## Caution

- Movie digital IS will not function when the lens's optical Image Stabilizer switch is set to < OFF >.
- With non-IS lenses, setting [ Digital IS] to [On] or [Enhanced] also sets [IS mode] to [On].
- Although movies can also be recorded with Movie digital IS when using EF-S lenses or movie cropping, the image area is further reduced.
- With a lens whose focal length is longer than 1000 mm, Movie digital IS will not function.
- Stabilization by Movie digital IS may be less effective at some movie recording sizes.
- The wider the angle of view (wide angle), the more effective the image stabilization will be. The narrower the angle of view (telephoto), the less effective the image stabilization will be.
- When using a tripod, setting Movie digital IS to [Off] is recommended.
- Depending on the subject and shooting conditions, the subject may blur noticeably (the subject momentarily looks out of focus) due to the effects of the Movie digital IS.
- Consider setting to [Off] when using a TS-E lens or fish-eye lens.
- Since Movie digital IS magnifies the image, the image looks more grainy. Noise, dots of light, etc. may also become noticeable.

## Note

- For details on configuring image stabilization for still photo shooting, see [Image Stabilizer \(IS Mode\)](#).
- With some lenses, even more effective stabilization (indicated by "+" next to the IS icon) is possible when the lens's IS is used in conjunction with [IS mode] and [Movie digital IS] on the camera. For details on lenses compatible with this feature, visit the Canon website.



## Shutter Button Function for Movies

---

You can set the functions performed by pressing the shutter button halfway or completely during movie recording.

### ⚠ Caution

- In movie recording, the **[Shutter btn function for movies]** setting overrides any function assigned to the shutter button in **[Customize buttons]**.

1. Select **[Shutter btn function for movies]**.

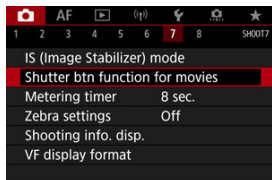

## 2. Select an option.

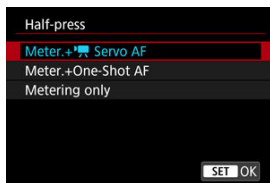

- **Half-press**  
Specify the function performed by pressing the shutter button halfway.
- **Fully-press**  
Specify the function performed by pressing the shutter button completely.

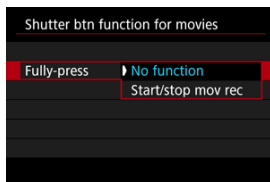

With **[Fully-press]** set to **[Start/stop mov rec]**, you can start/stop movie recording not only with the movie shooting button but also by pressing the shutter button completely, or by using Remote Switch TC-80N3 (sold separately).

To help you adjust exposure before or during movie recording, you can display a striped pattern over or around image areas of a specified brightness.

---

1. Select [: Zebra settings].

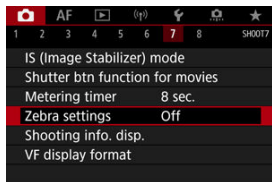

2. Select [Zebra].

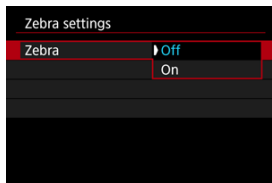

- Select [**On**].

### 3. Select [Zebra pattern].

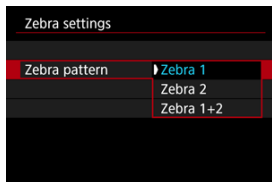

- **[Zebra 1]**: Displays left-slanting stripes around areas of the specified brightness.
- **[Zebra 2]**: Displays right-slanting stripes over areas that exceed the specified brightness.
- **[Zebra 1+2]**: Displays both **[Zebra 1]** and **[Zebra 2]**. An overlapping zebra pattern is displayed where the **[Zebra 1]** and **[Zebra 2]** display areas overlap.

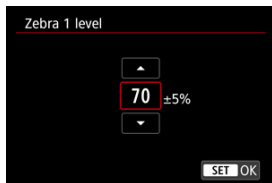

### 4. Set the level.

#### Zebra 1 level



#### Zebra 2 level



- Set by turning the  > or <  > dial or pressing <  > up or down.



## Note

- The maximum brightness value does not reach 100% when HDR-PQ is set. Note that the maximum brightness value varies depending on [📷: **Highlight tone priority**] and [📷: **Picture Style**] settings.
- The maximum brightness value does not reach 100% when Canon Log or an expanded ISO speed is set.
- Checking the zebra display level in advance is recommended when you will set [Zebra pattern].

## Time Code

---

- [Count Up](#)
- [Start Time Setting](#)
- [Movie Recording Count](#)
- [Movie Play Count](#)
- [HDMI](#)
- [Drop Frame](#)

Time codes record the time automatically as movies are recorded. Time codes always record elapsed hours, minutes, seconds, and frames. They are mainly used when movies are edited.

To set up the time code, use [: **Time code**].

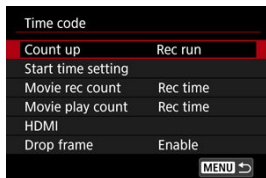

### Caution

- Time codes may not be displayed correctly if your movies are played back on devices other than the camera.

## Count Up

---

- **Rec run**

The time code advances only during movie recording. Time codes in each movie file recorded continue from the last time code in the previous file.

- **Free run**

The time code keeps advancing, even when you are not recording.

 **Caution**

- When set to **[Free run]**, time codes are not added to High Frame Rate movies that you record.
- When set to **[Free run]**, time codes will be affected by any changes to settings for time, zone, or daylight saving time (🕒).

## Start Time Setting

---

You can set the initial time of the time code.

- **Manual input setting**  
Enables you to set any starting hour, minute, second, and frame.
- **Reset**  
Resets the time set with **[Manual input setting]** or **[Set to camera time]** to "00:00:00."  
or "00:00:00:" (Ⓢ).
- **Set to camera time**  
Matches the hour, minute, and second set as the time on the camera. Sets the frame value to "00."



## Movie Recording Count

You can select how time is displayed on the movie recording screen.

- **Rec time**  
During recording standby, displays the available recording time. During recording, displays the time that has elapsed since movie recording began (1).
- **Time code**  
Displays the time code during movie recording (2).



### Caution

- Display of the available recording time may change during recording standby.

## Movie Play Count

You can select how time is displayed on the movie playback screen.

- **Rec time**  
Displays the recording or playback time during movie playback.
- **Time code**  
Displays the time code during movie playback.



### Note

- Time codes are always recorded to movie files (except for High Frame Rate movies set to **[Free run]**), regardless of the **[Movie rec count]** setting.
- The **[Movie play count]** setting in **[Camera: Time code]** is linked to the **[Player: Movie play count]**, so that these settings always match.
- The “frame” count is not displayed during movie recording or playback.

## HDMI

### ● Time code

Time codes can be added to movies as you record them to an external device via HDMI.

#### • Off

No time code is added to HDMI video output.

#### • On

Time codes are added to HDMI video output. When **[On]** is set, **[Rec Command]** is displayed.

### ● Rec Command

For HDMI video output recorded by an external device, you can synchronize recording to when you start and stop recording movies on the camera.

#### • Off

Recording is started and stopped by the external device.

#### • On

Recording by an external device is synchronized to starting/stopping recording on the camera.



### Caution

- Time codes are not added to HDMI video output when you record High Frame Rate movies with **[Count up]** in **[Time code]** set to **[Free run]**.
- To determine compatibility of external recording devices with **[Time code]** and **[Rec Command]** functions, check with the device manufacturer.
- Even with **[Time code]** set to **[Off]**, external recording devices may add time codes to movies, depending on their specifications. For details on device specifications relevant to adding time code to HDMI input, check with the device manufacturer.

## Drop Frame

The time code's frame count will cause a discrepancy between the actual time and the time code if the frame rate is set to **119.9P** (119.9 fps), **59.94P** (59.94 fps), or **29.97P** (29.97 fps). The discrepancy is corrected automatically when **[Enable]** is set.

- **Enable**

Corrects the discrepancy automatically by skipping time code numbers (DF: drop frame).

- **Disable**

The discrepancy is not corrected (NDF: non-drop frame).  
Time codes are displayed as follows.

- **Enable (DF)**

00:00:00. (Playback: 00:00:00.00)

- **Disable (NDF)**

00:00:00. (Playback: 00:00:00:00)



### Note

- The **[Drop frame]** setting item is not displayed when the frame rate is set to **24.00P** (24.00 fps), **23.98P** (23.98 fps), or when **[Video system]** is set to **[For PAL]**.

## Other Menu Functions

---



### [CAMERA]

---

- **Exposure comp.** ☆

Exposure compensation can be adjusted in a range of  $\pm 3$  stops, in 1/3-stop increments. For details on exposure compensation, see [Manual Exposure Compensation](#).

- **ISO speed settings** ☆

- **ISO speed**

In [M] mode, you can set the ISO speed manually. You can also select ISO Auto.

- **ISO speed range**

You can set the manual ISO speed setting range (minimum and maximum). ISO expansion can also be configured.

- **Max for Auto**

You can set the maximum limit for ISO Auto in movie recording in [S], [TV], or [AV] mode or in [M] mode with ISO Auto.

- **Max for Auto**

You can set the maximum limit for ISO Auto in 8K/4K/Full HD time-lapse movie recording in [S], [TV], or [AV] mode or in [M] mode with ISO Auto.

- **HDR PQ settings** ☆

For details on HDR PQ settings, see [HDR PQ Settings](#).

- **Auto Lighting Optimizer** ☆

Brightness and contrast can be corrected automatically. For details on Auto Lighting Optimizer, see [Auto Lighting Optimizer](#).

- **Highlight tone priority** ☆

You can reduce overexposed, clipped highlights as you record movies. For details on Highlight tone priority, see [Highlight Tone Priority](#).

- **Av 1/8-stop incr.** ☆

- **Menu Screen**

You can set aperture values on a finer scale when recording movies with an RF lens.

Select **[Enable]** to change the aperture increment in **[Av]** or **[M]** mode from 1/3 stop (or 1/2 stop) to 1/8 stop.



**Caution**

- **[Av 1/8-stop incr.]** is not available (not displayed) when EF or EF-S lenses are used.
- When set to **[Enable]**, setting options in **[Exposure level increments]** are disabled and have no effect.

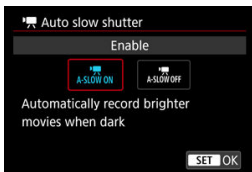
## ● Auto slow shutter ☆



You can choose whether to record movies that are brighter and less affected by image noise than when set to **[Disable]** by automatically slowing the shutter speed under low light.

Available in  or  recording mode. Applies when the frame rate of the movie recording size is **59.94P** or **50.00P**.

- **Disable**

Enables you to record movies with smoother, more natural movement, less affected by subject shake than when set to **[Enable]**. Note that under low light, movies may be darker than when set to **[Enable]**.

- **Enable**

Enables you to record brighter movies than when set to **[Disable]** by automatically reducing the shutter speed to 1/30 sec. (NTSC) or 1/25 sec. (PAL) under low light.

### Note

- Setting to **[Disable]** is recommended when recording moving subjects under low light, or when afterimages such as trails may occur.

- **White balance** ☆

For details on white balance, see [White Balance](#).

- **Custom White Balance** ☆

For details on custom white balance, see [Custom White Balance](#).

- **WB correction** ☆

For details on white balance correction, see [White Balance Correction](#).

- **Picture Style** ☆

For details on Picture Styles, see [Picture Style Selection](#).

- **Clarity** ☆

For details on clarity, see [Clarity](#).



- **Lens aberration correction** ☆

Peripheral illumination, distortion, chromatic aberration, and diffraction can be corrected as you record movies. For details on lens aberration correction, see [Lens Aberration Correction](#).

- **High ISO speed NR** ☆

For details on High ISO speed noise reduction, see [High ISO Speed Noise Reduction](#).

- **Remote control**

By setting to [**Enable**], you can start or stop movie recording with Remote Controller RC-6 or Wireless Remote Control BR-E1 (both sold separately).

- **Metering timer** ☆

For details on the metering timer, see [Metering Timer](#).

- **Shooting info. disp.** ☆

For details on shooting information display, see [Shooting Information Display](#).

- **VF display format** ☆

For details on the viewfinder display format, see [Viewfinder Display Format](#).

- **Overheat control**



Set to **[On]** to conserve battery power and help prevent the camera from overheating while waiting to shoot.

As a result, it may enable you to record movies over a longer period.

**⚠ Caution**

- Image quality on the standby screen may differ from image quality on the screen during movie recording.
- Briefly when you start recording movies, image display may remain on the current frame instead of being updated.

## ● HDMI display

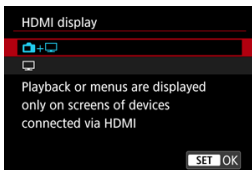

You can specify how movies are displayed as they are recorded via HDMI to an external device. Movie output itself corresponds to the **[Movie rec. size]** setting.

The default setting is **[+]**.

- **[+]**  
Enables movie display both on the camera screen and on the other device, via HDMI output.  
Camera operations such as image playback or menu display are shown on the other device via HDMI, not on the camera screen.
- **[]**  
Deactivates the camera screen during output via HDMI, so that the screen is blank. Shooting information, AF points, and other information is shown on the external device via HDMI, but you can stop output of this information by pressing the **<INFO>** button.  
Before recording movies externally, confirm that no information is being sent by the camera by making sure no shooting information, AF points, and so on is displayed on external monitors or other devices.

## ? For longer HDMI output

To continue HDMI output for longer than 30 min., select **[+]**, then set **[Auto power off]** in **[ Power saving]** to **[Disable]** (). HDMI output will continue after the camera screen turns off when the time set in **[Display off]** elapses.

### Caution

- HDMI output without information prevents display of warnings about the card space, battery level, or high internal temperature () via HDMI.
- During HDMI output, display of the next image may take some time if you switch between movies of different recording qualities or frame rates.
- Avoid operating the camera when recording movies to external devices, which may cause information to be displayed in the HDMI video output.
- Brightness and color of movies recorded with the camera may look different from that of HDMI video output recorded by external devices, depending on the viewing environment.



#### Note

- By pressing the <INFO> button, you can change the information displayed.
- Time codes can be added to HDMI video output (☑).
- Audio is also output via HDMI, except when [Sound rec.] is set to [Disable].





## General Movie Recording Precautions

### Caution





#### Precautions for movie recording

- Do not point the camera toward an intense light source, such as the sun or an intense artificial light source. Doing so may damage the image sensor or the camera's internal components.
- If you record something that has fine detail, moire or false colors may result.
- If [AWB] or [AWBW] is set and the ISO speed or aperture value changes during movie recording, the white balance may also change.
- If you record a movie under fluorescent or LED lighting, the movie image may flicker.
- If you perform AF with a USM lens during movie recording in low light, horizontal banding noise may be recorded in the movie. The same type of noise may occur if you focus manually with certain lenses equipped with an electronic focusing ring.
- Recording a few test movies is recommended if you intend to perform zooming during movie recording. Zooming as you record movies may cause exposure changes or lens sounds to be recorded, an uneven audio level, inaccurate lens aberration correction, or loss of focus.
- Large aperture values may delay or prevent accurate focusing.
- Performing AF during movie recording may cause the following kinds of issues: significant temporary loss of focus, recording of changes in movie brightness, temporary stopping of movie recording, or recording of mechanical lens sounds.
- Avoid covering the built-in microphones with your fingers or other objects.
- Connecting or disconnecting an HDMI cable during movie recording will end recording.
- If necessary, also see [General Still Photo Shooting Precautions](#).
- The camera may become hot in movie recording while connected via Wi-Fi. Use a tripod or take other measures to avoid handheld recording.

#### Red internal temperature warning icon

- If the camera's internal temperature increases due to prolonged movie recording or under a high ambient temperature, a red  icon will appear.
- The red  icon indicates that movie recording will soon be terminated automatically. If this happens, you will not be able to record again until the camera's internal temperature decreases, so turn off the power and let the camera cool down a while. Note that the time until movie recording stops automatically when the red  icon is displayed varies depending on shooting conditions.
- Recording a movie at a high temperature for a prolonged period will cause the red  icon to appear earlier. When you are not recording, always turn off the camera.

## icon

-  may be displayed if repeated movie recording or extended use of Live View display increases the camera's internal temperature. Turn off the camera or take other measures when  is displayed, and wait until the camera cools down.
- The camera will turn off automatically if you continue recording while  is displayed. The camera may also turn off automatically if you continue using Live View display while  is displayed.

## Recording and image quality

- If the attached lens has an Image Stabilizer and you set the Image Stabilizer switch to **< ON >**, the Image Stabilizer will operate at all times even if you do not press the shutter button halfway. This will consume battery power, and it may reduce the total movie recording time. When the Image Stabilizer is not necessary, such as when using a tripod, it is recommended that you set the Image Stabilizer switch to **< OFF >**.
- If the brightness changes as you record a movie with auto exposure, the movie may appear to stop momentarily. In this case, record movies with manual exposure.
- If there is a very bright light source in the image, the bright area may appear black on the screen. Movies are recorded almost exactly as they appear on the screen.
- Image noise or irregular colors may occur when shooting at high ISO speeds, high temperatures, slow shutter speeds, or under low light. Movies are recorded almost exactly as they appear on the screen, except in time-lapse movie recording or with Canon Log View Assist.
- Video and audio quality of recorded movies may be worse on other devices, and playback may not be possible, even if the devices support MP4 formats.
- If you use a card with a slow writing speed, an indicator may appear on the right of the screen during movie recording. The indicator shows how much data has not yet been written to the card (remaining capacity of the internal buffer memory), and it increases more quickly the slower the card is. If the indicator (1) becomes full, movie recording will stop automatically.



- If the card has a fast writing speed, the indicator will not appear or the level (if displayed) will not increase much. First, record a few test movies to see if the card can write fast enough.
- If the indicator shows that the card is full, and movie recording stops automatically, the sound near the end of the movie may not be recorded properly.
- If the card's writing speed is slow (due to fragmentation) and the indicator appears, formatting the card may make the writing speed faster.



## Audio restrictions

- Note that the following restrictions apply in [AF-ON] mode when [CAM: Movie rec quality] is set to [FHD 29.97P (IPB)] (NTSC) or [FHD 25.00P (IPB)] (PAL), or when [CAM: Audio compression] is set to [Enable].
  - Sound will not be recorded for approx. the last two frames.
  - When you play back movies in Windows, movie images and sound may become slightly out of synchronization.

## Note

### Notes for movie recording

- Each time you record a movie, a new movie file is created on the card.
- Field of view (coverage) is approx. 100%.
- Focusing is also possible by pressing the < AF-ON > button.
- To enable starting/stopping movie recording by pressing the shutter button completely, set [Fully-press] for [CAM: Shutter btn function for movies] to [Start/stop mov rec] (ON).
- The built-in microphone (ON) records in mono.
- Any external microphones such as Directional Stereo Microphone DM-E1 (sold separately) connected to the camera's external microphone IN terminal are used instead of the built-in microphones (ON).
- Most external microphones equipped with a 3.5 mm mini-jack can be used.
- Focus preset during movie recording is available when using (super) telephoto lenses equipped with this function released in and after the second half of 2011.
- YCbCr 4:2:0 (8-bit) color sampling and the BT.709 color space are used for 8K (except RAW), 4K, and Full HD movies.

## AF/Drive

---

This chapter describes autofocus operation and drive modes and introduces menu settings on the AF **[AF]** tab.

☆ to the right of titles indicates functions only available in **[Fv]**, **[P]**, **[Tv]**, **[Av]**, **[M]**, or **[BULB]** mode.

### Note

- < **AF** > stands for autofocus. < **MF** > stands for manual focus.

- [Tab Menu: AF \(Still Photos\)](#)
- [Tab Menu: AF \(Movie Recording\)](#)
- [AF Operation](#) ☆
- [Selecting the AF Method](#) ☆
- [Continuous AF](#)
- [Movie Servo AF](#)
- [Touch & Drag AF Settings](#)
- [Manual Focus](#)
- [Servo AF Characteristics](#) ☆
- [Customizing AF Functions](#) ☆
- [Selecting the Drive Mode](#)
- [Using the Self-Timer](#)
- [Remote Control Shooting](#)

## Tab Menus: AF (Still Photos)

### ● AF1

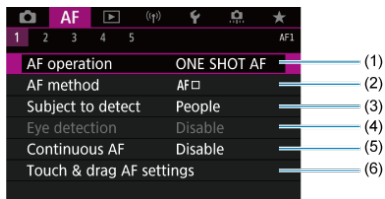

- (1) [AF operation](#) ☆
- (2) [AF method](#) ☆
- (3) [Subject to detect](#)
- (4) [Eye detection](#)
- (5) [Continuous AF](#)
- (6) [Touch & drag AF settings](#)

#### Note

- When lenses without a focus mode switch are used, **[Focus mode]** is displayed on the **[AF1]** tab.

### ● AF2

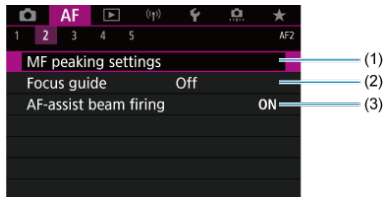

- (1) [MF peaking settings](#) ☆
- (2) [Focus guide](#)
- (3) [AF-assist beam firing](#)

● AF3

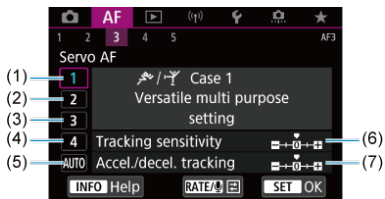

- (1) [Case 1](#)
- (2) [Case 2](#)
- (3) [Case 3](#)
- (4) [Case 4](#)
- (5) [Case A](#)
- (6) [Tracking sensitivity](#)
- (7) [Accel./decel. tracking](#)

● AF4

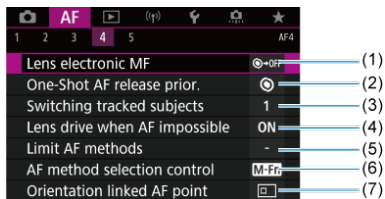

- (1) [Lens electronic MF](#) ☆
- (2) [One-Shot AF release prior.](#) ☆
- (3) [Switching tracked subjects](#) ☆
- (4) [Lens drive when AF impossible](#) ☆
- (5) [Limit AF methods](#) ☆
- (6) [AF method selection control](#) ☆
- (7) [Orientation linked AF point](#) ☆

## ● AF5

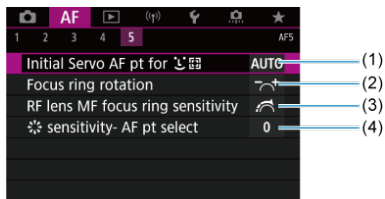

- (1) [Initial Servo AF pt for \[icon\] ☆](#)
- (2) [Focus ring rotation](#)
- (3) [RF lens MF focus ring sensitivity](#)
- (4) [sensitivity- AF pt select](#)

In [AF+] mode, the following screens are displayed.

## ● AF1



- (1) [Subject to detect](#)
- (2) [Eye detection](#)
- (3) [Continuous AF](#)
- (4) [Movie Servo AF](#)
- (5) [Touch & drag AF settings](#)
- (6) [Focus guide](#)
- (7) [AF-assist beam firing](#)

● AF2

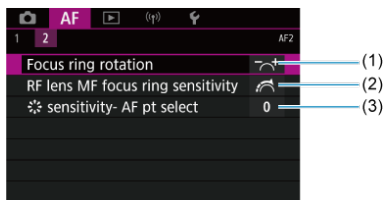

- (1) [Focus ring rotation](#)
- (2) [RF lens MF focus ring sensitivity](#)
- (3) [sensitivity- AF pt select](#)

## Tab Menus: AF (Movie Recording)

### ● AF1

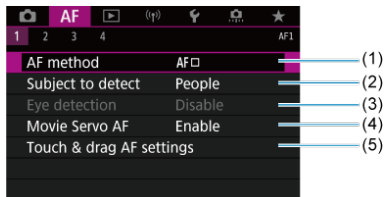

- (1) [AF method](#)
- (2) [Subject to detect](#)
- (3) [Eye detection](#)
- (4) [Movie Servo AF](#)
- (5) [Touch & drag AF settings](#)

#### Note

- When lenses without a focus mode switch are used, **[Focus mode]** is displayed on the **[AF1]** tab.

### ● AF2

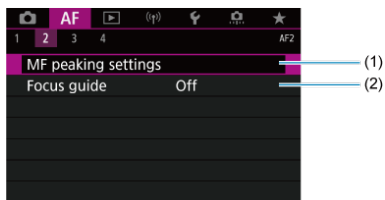

- (1) [MF peaking settings](#) ☆
- (2) [Focus guide](#)

● AF3



- (1) [Movie Servo AF speed](#) ☆
- (2) [Movie Servo AF track sens.](#) ☆
- (3) [Lens electronic MF](#) ☆
- (4) [Switching tracked subjects](#) ☆
- (5) [Lens drive when AF impossible](#) ☆
- (6) [Limit AF methods](#) ☆
- (7) [AF method selection control](#) ☆

● AF4

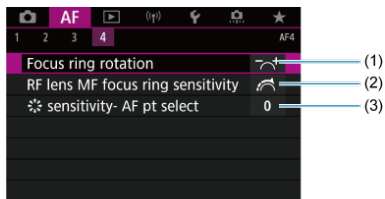

- (1) [Focus ring rotation](#)
- (2) [RF lens MF focus ring sensitivity](#)
- (3) [sensitivity- AF pt select](#)



In [AF] mode, the following screens are displayed.

## ● AF1

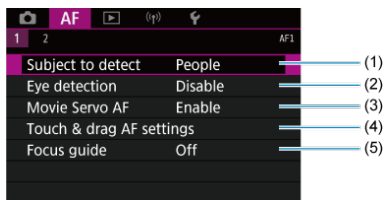

- (1) [Subject to detect](#)
- (2) [Eye detection](#)
- (3) [Movie Servo AF](#)
- (4) [Touch & drag AF settings](#)
- (5) [Focus guide](#)

## ● AF2

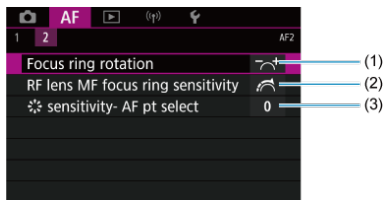

- (1) [Focus ring rotation](#)
- (2) [RF lens MF focus ring sensitivity](#)
- (3) [sensitivity- AF pt select](#)

☑ [One-Shot AF for Still Subjects](#)

☑ [Servo AF for Moving Subjects](#)

You can select the AF operation characteristics to suit the shooting conditions or subject.

---

1. Set the lens's focus mode switch to <AF>.

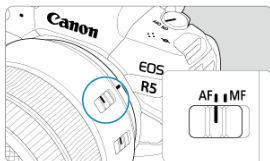

2. Select [**AF**: AF operation].

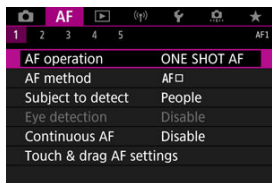

3. Select an option.

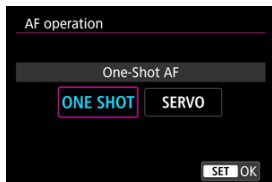



#### Note

- If focus is not achieved, the AF point will turn orange. With One-Shot AF, shooting is not possible even by pressing the shutter button completely. Recompose the shot and try to focus again. Or, see [Shooting Conditions That Make Focusing Difficult](#).
- With Servo AF, the camera shoots even when subjects are not in focus.

## One-Shot AF for Still Subjects

---

This AF operation is suited for still subjects. When you press the shutter button halfway, the camera will focus only once.

- When focus is achieved, the AF point will turn green and the beeper will sound.
- The focus remains locked while you hold down the shutter button halfway, allowing you to recompose the image before taking the picture.
- For details on the continuous shooting speed for continuous shooting, see [Selecting the Drive Mode](#).



### Note

- If [**Beep**] is set to [**Disable**], the beeper will not sound when focus is achieved.
- See [Lens electronic MF](#) when using a lens that supports electronic manual focusing.

## Servo AF for Moving Subjects

---

This AF operation is suited for moving subjects. While you hold down the shutter button halfway, the camera will keep focusing on the subject continuously.

- When focus is achieved, the AF point will turn blue. The beeper will not sound even when focus is achieved.
- The exposure is set at the moment the picture is taken.
- For details on the continuous shooting speed for continuous shooting, see [Selecting the Drive Mode](#).
- In **[A+]** mode, by default, the camera automatically switches to Servo AF in response to subject movement.



### Caution

- Depending on the lens used, the distance to the subject and the subject's speed, the camera may not be able to achieve correct focus.
- Zooming during continuous shooting may throw off the focus. Zoom first, then recompose and shoot.

## Selecting the AF Method

---

- [AF Method](#) ☆
- [Selecting the AF Method](#) ☆
- [\(Face\)+Tracking:](#)  ☆
- [Subject to Detect](#)
- [Eye Detection](#)
- [Spot AF / 1-Point AF / Expand AF Area: / Expand AF Area: Around / Zone AF / Large Zone AF: Vertical / Large Zone AF: Horizontal](#) ☆
- [Magnified View](#)
- [AF Shooting Tips](#)
- [Shooting Conditions That Make Focusing Difficult](#)
- [AF Range](#)

### AF Method

---



#### : +Tracking

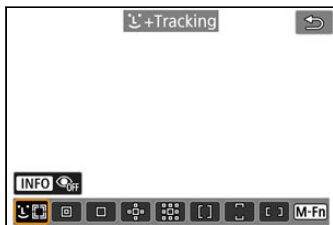

The camera detects and focuses on faces of people or animals. An AF point [] appears over any face detected, which is then tracked.  
If no face is detected, the entire AF area is used for auto selection AF.

With Servo AF, you can set the initial position for Servo AF (📍). As long as the Area AF frame can track the subject during shooting, focusing will continue.

### 📍: Spot AF

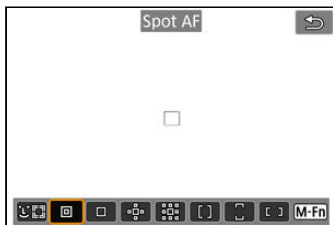

The camera focuses in a narrower area than 1-point AF.

### □: 1-point AF

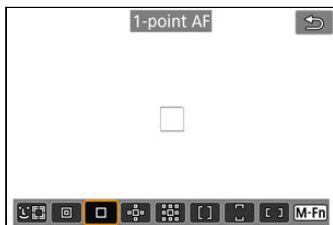

The camera focuses using a single AF point (□).

## : Expand AF area:

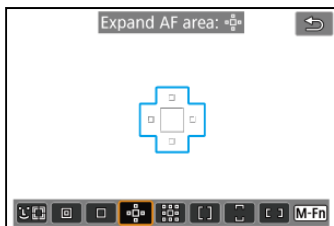





Focuses using one AF point () and AF points outlined here in blue. Effective for moving subjects, which are difficult to track with 1-point AF.

Focusing on your preferred subject is easier than with Zone AF.

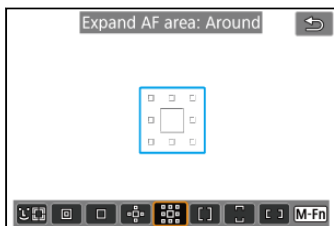
When Servo AF is used, first you will focus using an AF point ()

## : Expand AF area: Around



Focuses using one AF point () and surrounding AF points outlined here in blue, which makes it easier to focus on moving subjects than with Expand AF area: . Servo AF operation is the same as for Expand AF area: .



## [ ]: Zone AF

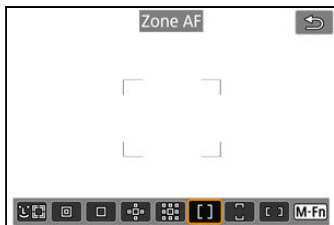

Uses auto selection AF in Zone AF frames to cover a larger area than Expand AF area, which makes focusing easier than with Expand AF area.

Focusing areas are determined not only based on the nearest subject but also based on a variety of other conditions such as faces (of people or animals), subject motion, and subject distance.

AF points in focus are displayed with [ ].

## [ ]: Large Zone AF: Vertical

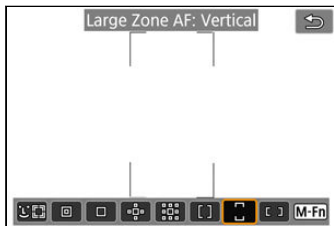

Uses auto selection AF in a vertical Large Zone AF frame to cover a larger area than Zone AF, which makes focusing easier than with 1-point AF/Expand AF area and also effective for moving subjects.

Focusing areas are determined not only based on the nearest subject but also based on a variety of other conditions such as faces (of people or animals), subject motion, and subject distance.

AF points in focus are displayed with [ ].

## ☐ : Large Zone AF: Horizontal

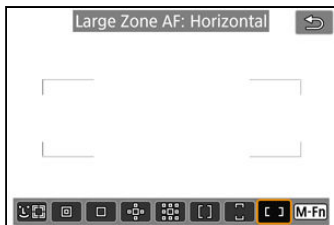

Uses auto selection AF in a horizontal Large Zone AF frame to cover a larger area than Zone AF, which makes focusing easier than with 1-point AF/Expand AF area and also effective for moving subjects.

Focusing areas are determined not only based on the nearest subject but also based on a variety of other conditions such as faces (of people or animals), subject motion, and subject distance.

AF points in focus are displayed with ☐.

You can select the AF method to suit the shooting conditions or subject. If you prefer to focus manually, see [Manual Focus](#).

## 1. Select [AF: AF method].

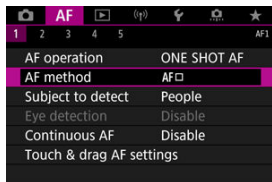

## 2. Select the AF method.

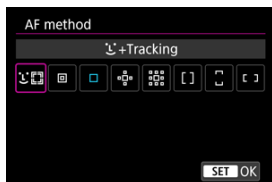

### Note

- In **[AF]** mode, **[L+Tracking]** is set automatically.
- To set the AF method, you can also press the **< [ ] >** button and then the **< M-Fn >** button.
- The following descriptions apply to the camera with AF operation set to **[One-Shot AF]** (☑). With **[Servo AF]** (☑) set, the AF point will turn blue when focus is achieved.

The camera detects and focuses on faces of people or animals. If a face moves, the AF point [ ] also moves to track the face.

You can set [**AF: Eye detection**] to [**Enable**] to shoot with the subject's eyes in focus (☑).

## 1. Check the AF point.



- An AF point [ ] appears over any face detected.
- To choose a face to focus on when multiple faces can be detected, press the < [ ] > button to change the AF point to [ ], then use < ✨ >. As you use < ✨ >, the AF point changes again to [ ].
- You can also tap the screen to choose a face.

## 2. Focus and take the picture.

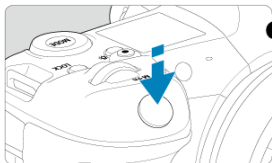

- Once you press the shutter button halfway and the subject is in focus, the AF point turns green and the camera beeps. An orange AF point indicates that the camera could not focus on subjects.

### Note

- Selecting the face of a person or animal manually by tapping the screen or using  $\langle \text{AF} \rangle$  changes the AF frame to  $\left[ \begin{array}{c} \text{AF} \\ \text{LOCK} \end{array} \right]$  and locks onto that subject for tracking, and the camera tracks the subject even if it moves within the screen.
- To release locked tracking, tap  $\left[ \begin{array}{c} \text{AF} \\ \text{OFF} \end{array} \right]$  or press  $\langle \text{SET} \rangle$ .

## Caution



- Tapping the screen to focus will focus with **[One-Shot AF]**, regardless of the AF operation setting.
- If the subject's face is significantly out of focus, face detection will not be possible. Adjust the focus manually () so that the face can be detected, then perform AF.
- Objects other than a human face or animal face or body may be detected.
- Face detection will not work if the face is very small or large in the picture, too bright or too dark, or partially hidden.
- Face detection for animals is not possible when the subject is too far away or does not face the camera steadily. AF points are displayed over the entire body.
- Detection is not possible for birds camouflaged in a forest, or similar situations.
- AF may not detect subjects or people's faces at the edges of the screen. Recompose the shot to center the subject or bring the subject closer to the center.

## Note

- For human subjects, the active [] may cover only a part of the face, not the whole face.
- The size of the AF point changes depending on the subject.

## Setting the initial Servo AF position

You can manually set the initial Servo AF position when **[AF: Initial Servo AF pt for ]** is set to an option other than **[Auto]** ().

1. Set the AF method to **[+Tracking]** ().
2. Set AF operation to **[Servo AF]** ().

### 3. Set the AF point.

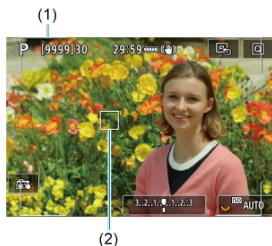

- An Area AF frame (1) and AF point (2) are displayed.
- To move the AF point into position for focusing, press the  $\langle \text{[AF-ON]} \rangle$  button and then use  $\langle \text{[Left/Right]} \rangle$ , or tap the screen, then press  $\langle \text{[SET]} \rangle$ .
- To center the AF point while using  $\langle \text{[Left/Right]} \rangle$ , press  $\langle \text{[Left/Right]} \rangle$  straight in.
- To center the AF point after you have confirmed it, tap  $\text{[AF-ON]}$  or press  $\langle \text{[SET]} \rangle$ .

## Subject to Detect

You can specify conditions for automatic selection of the main subject to track. Takes effect when the AF method is Face+Tracking, Zone AF, or Large Zone AF (vertical or horizontal).

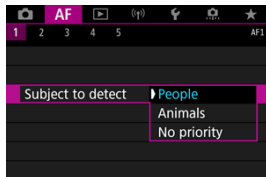

- **People**  
Prioritizes the faces or heads of people as the main subjects to track. When a person's face or head cannot be detected, the camera may track all or part of their body.
- **Animals**  
Detects animals (dogs, cats, or birds) and people and prioritizes detection results for animals as the main subjects to track. For animals, the camera attempts to detect faces or bodies, and AF points are shown over any faces detected. When an animal's face or entire body cannot be detected, the camera may track part of their body.
- **No priority**  
The camera determines the main subject automatically from the subject information detected.



## Eye Detection

With the AF method set to [**L**+Tracking], you can shoot with the eyes of people or animals in focus.

1. Select [**AF**: Eye detection].

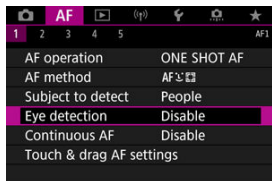

2. Select [Enable].

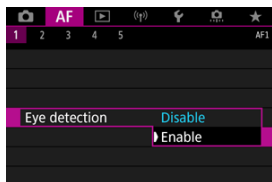

### 3. Aim the camera at the subject.



- An AF point is displayed around their eye.
- To choose an eye to focus on, press the < [ ] > button to change the AF point to [ [ ] ], then use < \* >. As you use < \* >, the AF point changes again to [ [ ] ].
- You can also tap the screen to choose an eye.
- If your selected eye is not detected, an eye to focus on is selected automatically.

### 4. Take the picture.

#### Caution

- Subject eyes may not be detected correctly, depending on the subject and shooting conditions.

#### Note

- To switch to [Eye detection: Disable] without using menu operations, press the < [ ] > button and then the < INFO > button. To switch to [Eye detection: Enable], press the < INFO > button again.

## Spot AF / 1-Point AF / Expand AF Area: $\square$ / Expand AF Area: Around / Zone AF / Large Zone AF: Vertical / Large Zone AF: Horizontal



You can manually set the AF point or Zone AF frame. Here, 1-point AF screens are used as an example.

### 1. Check the AF point.









(1)

- The AF point (1) will appear.
- With Expand AF area:  $\square$  or Expand AF area: Around, adjacent AF points are also displayed.
- With Zone AF, Large Zone AF: Vertical, or Large Zone AF: Horizontal, the specified Zone AF frame is displayed.

## 2. Move the AF point.



- Press the  button, use  to move the AF point into position for focusing, then press  (but note that with some lenses, it may not move to the edge of the screen).
- To center the AF point while using , press  straight in.
- You can also focus by tapping a position on the screen.
- To center the AF point or Zone AF frame, tap  or press .

## 3. Focus and take the picture.

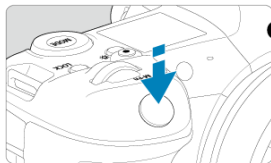

- Aim the AF point over the subject and press the shutter button halfway.



- When focus is achieved, the AF point will turn green and the beeper will sound.
- If focus is not achieved, the AF point will turn orange.

### Caution

- The camera continues to switch the active AF point [□] to track subjects when Zone AF or Large Zone AF (vertical or horizontal) is set to Servo AF, but tracking may not be possible under some shooting conditions, such as when subjects are small.
- Focusing may be difficult when using a peripheral AF point. In this case, select an AF point in the center.
- Tapping the screen to focus will focus with [One-Shot AF], regardless of the AF operation setting.

### Note

- With [AF: Orientation linked AF point], you can set separate AF points for vertical and horizontal shooting (🔗).

## Magnified View

To check the focus when the AF method is other than [**L**+Tracking], magnify display by approx. 6× or 15× by pressing the < Q > button (or tapping [Q]).

- Magnification is centered on the AF point for [**Spot AF**], [**1-point AF**], [**Expand AF area: 9**], and [**Expand AF area: Around**] and on the Zone AF frame for [**Zone AF**], [**Large Zone AF: Vertical**], and [**Large Zone AF: Horizontal**].
- Autofocusing is performed with magnified display if you press the shutter button halfway when set to [**Spot AF**], and [**1-point AF**]. When set to AF methods other than [**Spot AF**] and [**1-point AF**], autofocusing is performed after restoring normal display.
- With Servo AF, if you press the shutter button halfway in the magnified view, the camera will return to the normal view for focusing.

### Caution

- If focusing is difficult in the magnified view, return to the normal view and perform AF.
- If you perform AF in the normal view and then use the magnified view, accurate focus may not be achieved.
- AF speed differs between the normal view and magnified view.
- Continuous AF and Movie Servo AF are not available when display is magnified.
- With the magnified view, achieving focus becomes more difficult due to camera shake. Using a tripod is recommended.

## AF Shooting Tips

---

- Even when focus is achieved, pressing the shutter button halfway will focus again.
- Image brightness may change before and after autofocusing.
- Depending on the subject and shooting conditions, it may take longer to focus, or the continuous shooting speed may decrease.
- If the light source changes as you shoot, the screen may flicker, and focusing may be difficult. In this case, restart the camera and resume shooting with AF under the light source you will use.
- If focusing is not possible with AF, focus manually (☑).
- For subjects at the edge of the screen that are slightly out of focus, try centering the subject (or AF point, or Zone AF frame) to bring them into focus, then recompose the shot before shooting.
- With certain lenses, it may take more time to achieve focus with autofocus, or accurate focusing may not be achieved.

## Shooting Conditions That Make Focusing Difficult

---

- Subject with low-contrast such as the blue sky, solid-color flat surfaces or when highlight or shadow details are clipped.
- Subjects in low light.
- Stripes and other patterns where there is contrast only in the horizontal direction.
- Subjects with repetitive patterns (Example: Skyscraper windows, computer keyboards, etc.).
- Fine lines and subject outlines.
- Under light sources with constantly changing brightness, colors, or patterns.
- Night scenes or points of light.
- The image flickers under fluorescent or LED lighting.
- Extremely small subjects.
- Subjects at the edge of the screen.
- Strongly backlit or reflective subjects (Example: Car with a highly reflective surfaces, etc.).
- Near and distant subjects covered by an AF point (Example: Animal in a cage, etc.).
- Subjects that keep moving within the AF point and will not stay still due to camera shake or subject blur.
- Performing AF when the subject is very far out of focus.
- Soft focus effect is applied with a soft focus lens.
- A special effect filter is used.
- Noise (dots of light, banding, etc.) appears on the screen during AF.



## AF Range

---

The available autofocus range varies depending on the lens, aspect ratio, and image quality used, and whether you are recording 4K or 8K movies and using features such as movie cropping or Movie digital IS.

## Continuous AF

---

This function keeps subjects generally in focus. The camera is ready to focus immediately when you press the shutter button halfway.

---

1. Select [**AF: Continuous AF**].

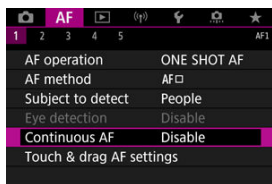

2. Select [**Enable**].

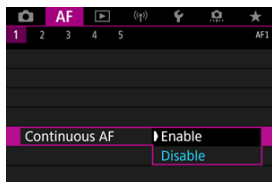

### ! Caution

- Fewer shots are available when set to [**Enable**], because the lens is driven continuously and battery power is consumed.

# Movie Servo AF

---

With this function enabled, the camera focuses on the subject continuously during movie recording.

---

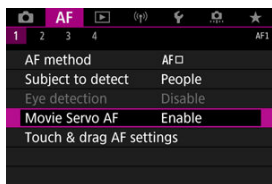

1. Select **[AF: Movie Servo AF]**.



## 2. Select [Enable].



### ● Enable

- The camera focuses on the subject continuously even when you are not pressing the shutter button halfway.
- To keep the focus at a specific position, or if you prefer not to record mechanical sounds from the lens, you can temporarily stop Movie Servo AF by tapping  in the lower left of the screen.
- When Movie Servo AF is paused, if you return to movie recording after operations such as pressing the < MENU > or <  > button or changing the AF method, Movie Servo AF will resume.

### ● Disable

Press the shutter button halfway or press the < AF-ON > button to focus.

 **Caution**

**Precautions when set to [Movie Servo AF: Enable]**

- **Shooting conditions that make focusing difficult**
  - A fast-moving subject approaching or moving away from the camera.
  - A subject moving at a close distance to the camera.
  - When shooting with a higher aperture value.
  - Also see [Shooting Conditions That Make Focusing Difficult](#).
- Since the lens is driven continuously and the battery power is consumed, the possible movie recording time (🕒) will be shortened.
- The camera's built-in microphone may also record mechanical sounds of the lens or sounds of camera/lens operations if AF operations are performed or the camera or lens is operated during movie recording. In this case, using an external microphone may reduce these sounds. If the sounds are still distracting with an external microphone, it may be more effective to remove the external microphone from the camera and position it away from the camera and lens.
- Movie Servo AF pauses during zooming or magnified view.
- During movie recording, if a subject approaches or moves away or if the camera is moved vertically or horizontally (panning), the recorded image may momentarily expand or contract (change in image magnification).

# Touch & Drag AF Settings

---

- [Touch & Drag AF](#)
- [Positioning Method](#)
- [Active Touch Area](#)

You can move the AF point or Zone AF frame by tapping or dragging on the screen as you look through the viewfinder.

---

## Touch & Drag AF

---

1. Select [**AF**: Touch & drag AF settings].

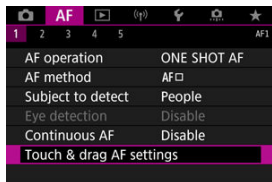

2. Select [Touch & drag AF].

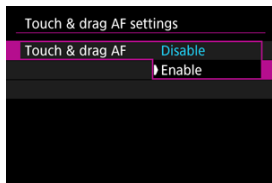

- Select [**Enable**].

## Positioning Method

---

You can set how positions are specified by tapping or dragging.

### 1. Set [Positioning method].

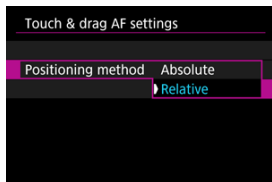

- **Absolute**  
The AF point moves to the tapped or dragged position on the screen.
- **Relative**  
The AF point moves in the direction you drag, by an amount corresponding to the amount you drag, no matter where you tap the screen.

## Active Touch Area

You can specify the area of the screen used for tap and drag operations.

### 1. Set [Active touch area].

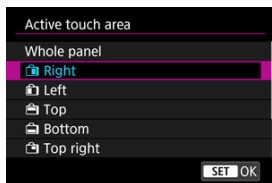

#### Note

- Tapping the screen when [**L**+Tracking] is set displays a round orange frame [C]. After you lift your finger at the position to move the AF point to, [R] is displayed and that subject is tracked. To cancel subject selection, press < [SET] >.



# Manual Focus

---

[Setting MF Peaking \(Outline Emphasis\)](#)

[Focus Guide](#)

[AF-Assist Beam Firing](#)

If focusing is not possible with autofocus, you can magnify the image and focus manually.

---

1. Set the lens's focus mode switch to <MF>.

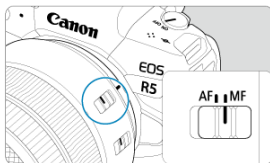

- Turn the lens focusing ring to set the approximate focus.

2. Magnify the image.



- Each press of the <Q> button changes the magnification ratio, as follows.

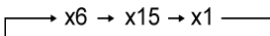

### 3. Move the magnified area.



- Use < \* > to move the magnified area into position for focusing.
- To center the magnified area, press < \* > straight in or press < SET >.

### 4. Focus manually.

- While looking at the magnified image, turn the lens focusing ring to focus.
- After achieving focus, press the < Q > button to return to the normal view.

#### Note

- In magnified view, the exposure is locked.
- Even when focusing manually, you can use Touch Shutter to shoot.

Edges of subjects in focus can be displayed in color to make focusing easier. You can set the outline color and adjust the sensitivity (level) of edge detection.

1. Select [**AF**: MF peaking settings].

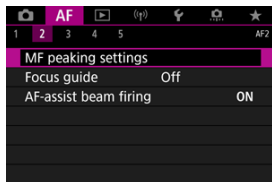

2. Select [**Peaking**].

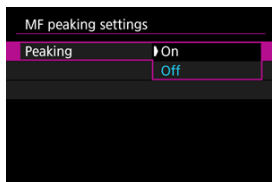

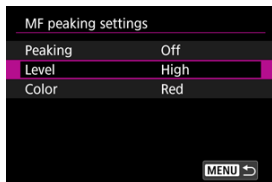

- Select [**On**].

3. Set [**Level**] and [**Color**].



- Set as necessary.

### Caution

- In magnified view, peaking display is not shown.
- During HDMI output, peaking display is not shown on equipment connected via HDMI. Note that peaking display is shown on the camera screen when [: HDMI display] is set to [].
- MF peaking may be hard to discern at high ISO speeds, especially when ISO expansion is set. If necessary, lower the ISO speed or set [**Peaking**] to [**Off**].

### Note

- Peaking display shown on the screen is not recorded in images.
- MF peaking may be hard to discern when Canon Log is set. If necessary, set [**View Assist.**] to [**On**].

## Focus Guide

Setting **[Focus guide]** to **[On]** provides a guide frame that shows which direction to adjust focus and the extent of adjustment needed. The guide frame is displayed near any eyes that are detected for the main subject when **[AF: AF method]** is set to **[L+Tracking]** and **[AF: Eye detection]** is set to **[Enable]**.

### 1. Select **[AF: Focus guide]**.

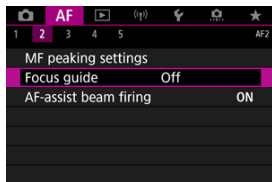

### 2. Select **[On]**.

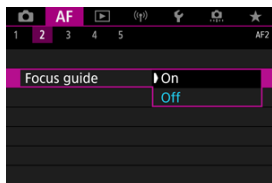

- After pressing the **[]** button, you can use **< >** to move the guide frame in the direction you press (except in **[]** mode).
- To center the guide frame while using **< >**, press **< >** straight in.
- To set the guide frame after moving it with **< >**, press **< >**.
- You can also move and set the guide frame by tapping the screen.
- To center the guide frame, tap **[]** or press **< >**.

The guide frame indicates the current position in focus and adjustment amount as follows.

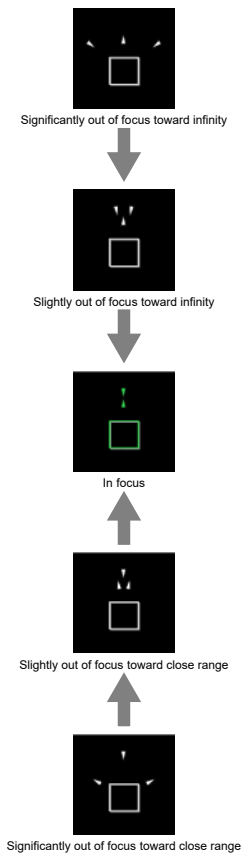

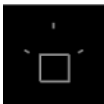

Adjustment information not detected

### Caution

- Under difficult shooting conditions for AF (AF-ON), the guide frame may not be displayed correctly.
- Higher aperture values are more likely to prevent correct guide frame display.
- No AF points are displayed while the guide frame is displayed.
- The guide frame is not displayed in these situations.
  - When the lens's focus mode switch is set to < AF >
  - When display is magnified
- The guide frame is not displayed correctly during shifting or tilting of TS-E lenses.

### Note

- The camera's auto power off counter does not count time spent adjusting the focus with a lens's electronic focusing ring.

## AF-Assist Beam Firing

You can enable or disable AF-assist beam firing of the camera or a Speedlite for EOS cameras.

### 1. Select [AF-assist beam firing].

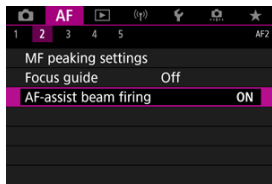

### 2. Select an option.

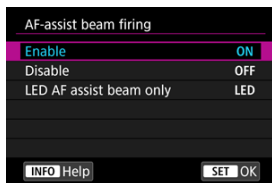

- **[ON] Enable**  
Enables firing of the AF-assist beam, when needed.
- **[OFF] Disable**  
Disables firing of the AF-assist beam. Set if you prefer not to fire the AF-assist beam.
- **[LED] LED AF assist beam only**  
Enables LED AF-assist beam firing by Speedlites equipped with this feature, when these flash units are attached. If your Speedlite is not LED-equipped, the camera's AF-assist beam is fired instead.



 **Caution**

- If a Speedlite's **[AF-assist beam firing]** Custom Function is set to **[Disable]**, the AF-assist beam will not be emitted.

- ☑ [Case Details](#)
- ☑ [Case 1: Versatile Multi-Purpose Setting](#)
- ☑ [Case 2: Continue to Track Subjects, Ignoring Possible Obstacles](#)
- ☑ [Case 3: Instantly Focus on Subjects Suddenly Entering AF Points](#)
- ☑ [Case 4: For Subjects That Accelerate or Decelerate Quickly](#)
- ☑ [Case A: Tracking Automatically Adapts to Subject Movement](#)
- ☑ [Parameters](#)
- ☑ [Adjusting Case Parameters](#)



Shooting with AI Servo AF/Servo AF can be easily tailored to your subjects or shooting situations by selecting a Case option. This feature is called the “AF Configuration Tool.”

---

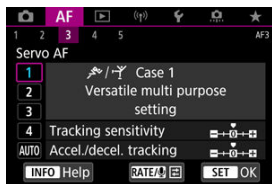
## 1. Select the [AF3] tab.







## 2. Select a case.

- Turn the <  > dial to select a case icon, then press <  >.
- Your selected case is now set. Selected cases are displayed in blue.

## Case Details

Cases 1 to A are five combinations of settings for "[Tracking sensitivity](#)" and "[Accel./decel. tracking](#)." Referring to the following table, select the case for your subject and shooting situation.

Case	Icon	Description	Examples of Shooting Situations
<a href="#">Case 1</a>		<b>Versatile multi purpose setting</b>	Moving subjects in general
<a href="#">Case 2</a>		<b>Continue to track subjects, ignoring possible obstacles</b>	Tennis, freestyle skiing
<a href="#">Case 3</a>		<b>Instantly focus on subjects suddenly entering AF points</b>	Start of a cycling race, downhill skiing
<a href="#">Case 4</a>		<b>For subjects that accelerate or decelerate quickly</b>	Soccer, rhythmic gymnastics, motorsports, basketball
<a href="#">Case A</a>		<b>Tracking automatically adapts to subject movement</b>	Moving subjects in general, especially in dynamic shooting situations

## Case 1: Versatile Multi-Purpose Setting

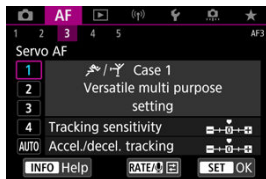

### Default

- Tracking sensitivity: 0
- Accel./decel. tracking: 0

Standard setting suited to moving subjects in general. Suitable for many kinds of subjects and scenes.

In the following situations, select [Case 2] to [Case 4] instead: non-subjects moving across AF points, elusive subjects, or subjects that suddenly appear or change speed.

## Case 2: Continue to Track Subjects, Ignoring Possible Obstacles

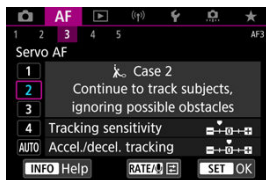

### Default

- **Tracking sensitivity:** Locked on: -1
- **Accel./decel. tracking:** 0

Setting to continue focusing on the subject even if non-subjects move across AF points, or if the subject strays from AF points. Effective if you prefer the focus not to switch to non-subjects or the background.

### Note

- Try setting [**Tracking sensitivity**] to [-2] if non-subjects tend to steal the focus or AF points tend to stray from the subject much of the time, preventing the camera from tracking the target subject under default settings (🔒).

## Case 3: Instantly Focus on Subjects Suddenly Entering AF Points

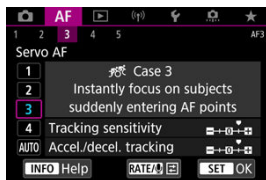

### Default

- **Tracking sensitivity: Responsive: +1**
- **Accel./decel. tracking: +1**

Setting to focus on a series of subjects at different distances in the AF points, one after another. Focus switches to any new subject that appears in front of the target subject. Also effective when you want to always focus on the closest subject.

### Note

- Try setting [**Tracking sensitivity**] to [**+2**] if you prefer focusing that immediately switches to new subjects that appear suddenly (🔒).

## Case 4: For Subjects That Accelerate or Decelerate Quickly

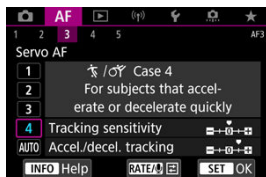

### Default

- Tracking sensitivity: Responsive: 0
- Accel./decel. tracking: +1

Setting to keep tracking and focusing on subjects even if they suddenly change speed. Effective for subjects having sudden movements, sudden acceleration/deceleration, or sudden stops.

### Note

- Try setting [**Accel./decel. tracking**] to [**+2**] to keep up with subjects that change speed significantly from moment to moment (📷).

## Case A: Tracking Automatically Adapts to Subject Movement

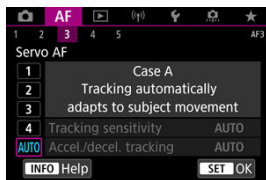

Useful when you prefer to shoot with parameters set automatically, based on how subjects change.

Tracking sensitivity and acceleration/deceleration tracking are set automatically.



### Tracking sensitivity

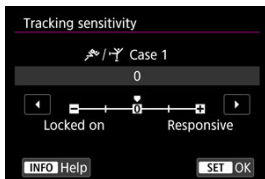

Setting for Servo AF subject-tracking sensitivity in response to non-subjects moving across AF points or subjects straying from AF points.

- **0**  
Standard setting. Suitable for moving subjects in general.
- **Locked on: -2 / Locked on: -1**  
The camera will try to continue focusing on the subject even if non-subjects move across AF points or if the subject strays from the AF points. The -2 setting makes the camera keep tracking the target subject longer than the -1 setting. However, if the camera focuses on a wrong subject, it may take slightly longer to switch and focus on the target subject.
- **Responsive: +2 / Responsive: +1**  
The camera can focus consecutively on subjects at different distances that are covered by the AF points. Also effective when you want to always focus on the closest subject. The +2 setting is more responsive than the +1 setting when focusing on the next subject. However, the camera will be more prone to focus on an unintended subject.

## Accel./decel. tracking

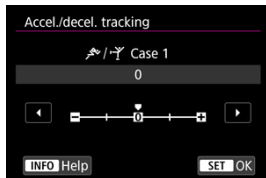

Setting for AI Servo AF/Servo AF subject-tracking sensitivity in response to sudden, significant changes in speed, as when subjects suddenly start or stop moving.

- **0**  
Suited for subjects that move at a steady speed (minor changes in moving speed).
- **-2 / -1**  
Suited for subjects that move at a steady speed (minor changes in moving speed). Effective when a setting of 0 makes focus unstable, due to slight subject movement or an obstruction in front of the subject.
- **+2 / +1**  
Effective for subjects having sudden movements, sudden acceleration/deceleration, or sudden stops. Even if the moving subject's speed suddenly changes significantly, the camera continues to focus on the target subject. For example, the camera is less likely to focus behind a subject that suddenly starts approaching you, or in front of an approaching subject that suddenly stops moving. Setting +2 can track dramatic changes in the moving subject's speed better than with +1.  
However, since the camera will be sensitive to even slight movements of the subject, focusing may become unstable for short periods.

## Adjusting Case Parameters

You can manually adjust the parameters ((1) Tracking sensitivity and (2) Acceleration/ deceleration tracking) for cases 1 to 4.

### 1. Select a case.

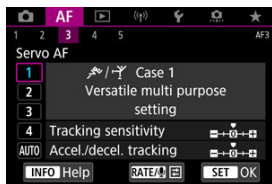

- Turn the <  > dial to select the number of a case to adjust.

### 2. Press the < RATE > button.

- The selected parameter is outlined in purple.

### 3. Select a parameter to adjust.

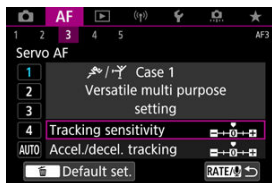

#### 4. Make the adjustment.

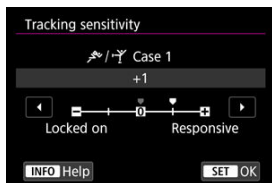

- Default settings are indicated by a light gray [ ] icon.
- To confirm the adjustment, press < [SET] >.
- To return to the screen in step 1, press the < [RATE] > button.

#### Note

- To restore default parameter settings for (1) and (2) to each case, press the < [RATE] > button in step 2, then press the < [ ] > button.
- You can also register (1) and (2) parameter settings to My Menu ( [M] ). This enables you to adjust settings for the selected case.
- To shoot with a case you have adjusted, first select the adjusted case, then shoot.

## Customizing AF Functions

---

☑ [AF4]

☑ [AF5]

☑ [AF3] (In Movie Recording)

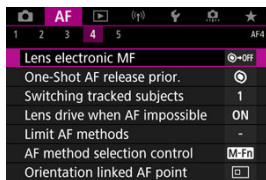

You can configure AF functions in detail to suit your shooting style or subject.

---

### [AF4]

---

#### Lens electronic MF ☆

For EF lenses equipped with electronic manual focusing, you can specify how manual focus adjustment is used with One-Shot AF.

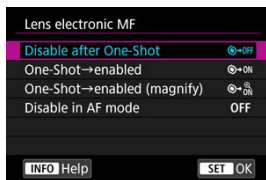

- [☉→OFF] **Disable after One-Shot**

After the AF operation, manual focusing adjustment is disabled.

- [☉→ON] **One-Shot→enabled**

You can manually adjust the focus after the AF operation if you keep holding down the shutter button halfway.

- **[ ON] One-Shot→enabled (magnify)**

You can manually adjust the focus after the AF operation if you keep holding down the shutter button halfway. You can magnify the area in focus and adjust the focus manually by turning the lens focusing ring.

- **[OFF] Disable in AF mode**

Manual focus adjustment is disabled when the lens's focus mode switch is set to < AF >.

 **Caution**

- With [**One-Shot→enabled (magnify)**], display may not be magnified even if you turn the lens focusing ring while pressing the shutter button halfway immediately after shooting. If so, you can magnify display by releasing the shutter button, waiting for [Q] display, then pressing the shutter button halfway as you turn the lens focusing ring.

 **Note**

- For details on your lens's manual focus specifications, refer to the Lens Instruction Manual.

## One-Shot AF release prior. ☆

You can specify whether to prioritize focus or release timing for One-Shot AF (except when shooting with Touch Shutter).

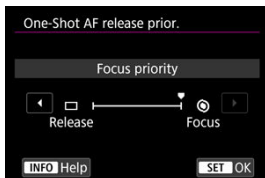

- **[⊙] Focus**

The picture will not be taken until focus is achieved. Useful when you want to achieve focus before capturing the image.

- **[□] Release**

Prioritizes shutter release over focus. Useful when capturing the decisive moment is most important.

**Note that the camera shoots whether or not the subject is in focus.**

## Switching tracked subjects ☆

You can specify how easily the camera switches AF points to track subjects.

Applies to Face+Tracking, Zone AF, or Large Zone AF (vertical or horizontal) AF methods.

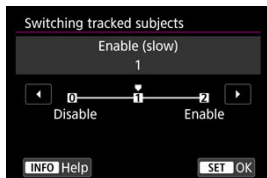

- **Disable**  
Tracks the subject initially determined for AF, to the extent possible.
- **Enable (slow)**  
Tracks the main subject initially determined for AF, to the extent possible. Switches to other subjects if the camera can no longer determine if the tracked subject is the main subject.
- **Enable**  
Switches to track other subjects in response to shooting conditions.

### ⚠ Caution

#### Precautions when set to [Disable]

- The camera may not be able to continue tracking subjects under some subject conditions.
  - If subjects move vigorously
  - If subjects face a different direction or change their posture
  - If AF points stray from subjects, or if subjects are hidden behind obstructions and you can no longer see them
- Subjects selected by touch are tracked to the extent possible, regardless of the [Subject to detect] setting.



## Lens drive when AF impossible ☆

You can specify lens operation that applies when autofocusing on a subject is not possible.

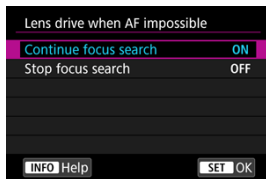

- **[ON] Continue focus search**

If focus cannot be achieved with autofocus, the lens is driven to search for the precise focus.

- **[OFF] Stop focus search**

If autofocus starts and the focus is far off or if focus cannot be achieved, the lens drive will not be performed. This prevents the lens from becoming grossly out of focus due to the focus search drive.

### ⚠ Caution

- **[Stop focus search]** is recommended for super telephoto lenses or other lenses that are driven over a large focus area, to avoid significant delay from focus search drive if the lens becomes greatly out of focus.

## Limit AF methods ☆

You can limit the AF methods available to those that you will use. Select AF methods and press < **SET** > to add a checkmark [✓] and make them available. Select [**OK**] to register the setting. For details on AF methods, see [AF Method](#).

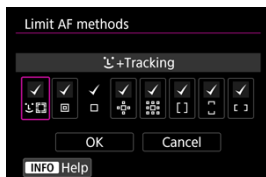

### ⚠ Caution

- The [✓] mark cannot be removed from [**Manual selection:1 pt AF**].

### 📄 Note

- An asterisk "\*" to the right of [**AF: Limit AF methods**] indicates that the default setting has been modified.

## AF method selection control ☆

You can set how AF method selection methods are switched.

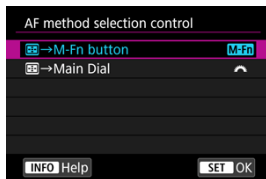

- **[M-Fn] → M-Fn button**

Press the < [M-Fn] > button, then the < M-Fn > button. Each press switches the AF method.

- **[Main Dial] → Main Dial**

Press the < [Main Dial] > button, then turn the < Main Dial > dial to switch the AF method.

### Note

- When **[Main Dial] → Main Dial** is set, use < [Main Dial] > to move the AF point horizontally.

## Orientation linked AF point ☆

You can set separate AF points or Zone AF frames to use in vertical and horizontal shooting.

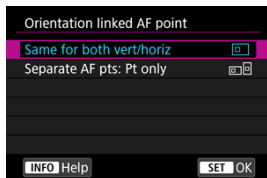

- **[□] Same for both vert/horiz**

The same AF points or Zone AF frames are used in both vertical and horizontal shooting.

- **[□] Separate AF pts: Pt only**

Separate AF points or Zone AF frames can be set for each camera orientation ((1) Horizontal, (2) Vertical with the camera grip up, (3) Vertical with the camera grip down). Useful when switching to other AF points or Zone AF frames automatically based on camera orientation.

AF points or Zone AF frames you assign to each of the three camera orientations are retained.





### Caution

- The default setting of **[Same for both vert/horiz]** is restored if you select **[Basic settings]** in **[🔧: Reset camera]** (🔧). Settings for orientations (1)–(3) are cleared, and the camera is set to use the center AF point in 1-point AF.
- The setting may be cleared if you switch lenses.

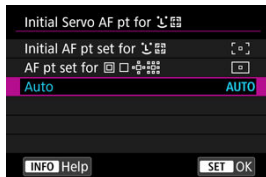

## Initial Servo AF pt for ☆

You can set the initial AF point for Servo AF when the AF method is set to [**L**+Tracking].



- **Initial AF pt set for **  
Servo AF starts from the manually set AF point when AF operation is set to [Servo AF] and the AF method is set to [**L**+Tracking].
- **AF pt set for   **  
Servo AF starts from the AF point that was set manually before switching from Spot AF, 1-point AF, or Expand AF area (manual selection ) or Expand AF area (manual selection: surround) to [Auto selection AF] or [**L**+Tracking]. Useful for starting Servo AF from the AF point set before switching to [Auto selection AF] or [**L**+Tracking].
- **AUTO: Auto**  
The initial AF point for Servo AF is set automatically to suit the shooting conditions.

### Note

- When [AF pt set for   ] is set, Servo AF starts from a zone corresponding to your manually selected AF point even if you switch the AF method to Zone AF or Large Zone AF (vertical or horizontal).

## Focus ring rotation

You can reverse the direction that the focusing ring of RF lens is rotated to adjust settings.

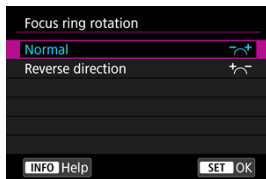

- [↶↷] Normal
- [↷↶] Reverse direction

## RF lens MF focus ring sensitivity

You can set the sensitivity of the RF lens focusing ring.

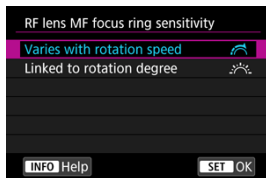

- [↶↷] **Varies with rotation speed**  
Focusing ring sensitivity varies depending on rotation speed.
- [☀️↶↷] **Linked to rotation degree**  
The focal position is adjusted based on the amount of rotation, regardless of the rotation speed.

## ✿ sensitivity- AF pt select

You can adjust Multi-controller sensitivity, which applies to AF point positioning.

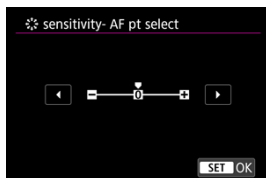

### Movie Servo AF speed ☆

This function is available when [**AF: Movie Servo AF**] is set to [**Enable**]. You can set the AF speed and operating conditions for Movie Servo AF. The function is enabled when using a lens supporting slow focus transition during movie recording.\*

#### ● When active

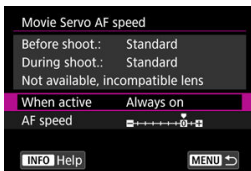

You can set [**Always on**] to have the AF speed take effect at all times for movie recording (before and during movie recording) or set [**During shooting**] to have the AF speed take effect only during movie recording.

#### ● AF speed

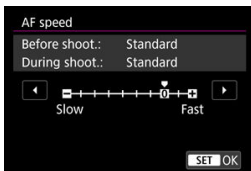

You can adjust the AF speed (focus transition speed) from the standard speed (0) to slow (one of seven levels) or fast (one of two levels) to obtain the desired effect for the movie creation.

#### \* Lenses supporting slow focus transition during movie recording

USM and STM lenses released in and after 2009 are compatible. For details, refer to the Canon website.

#### ⚠ Caution

- With certain lenses, even if you adjust the AF speed, the speed may not change.



#### Note

- Operation when inactive is equivalent to when [AF speed] is set to [Standard (0)].
- An asterisk "\*" to the right of [AF: Movie Servo AF speed] indicates that the default setting has been modified.

## Movie Servo AF track sens. ☆

You can adjust the tracking sensitivity (to one of seven levels), which affects responsiveness if the subject strays from the AF point during Movie Servo AF, as when interfering objects move across AF points or when you pan.

This function is available when [AF: Movie Servo AF] is set to [Enable].

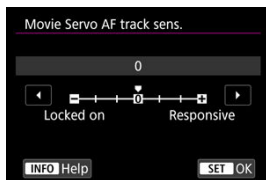

- **Locked on: -3/-2/-1**

With this setting, the camera is less likely to track a different subject if the subject strays from the AF point. The closer the setting is to the minus (-) symbol, the less the camera is inclined to track a different subject. It is effective when you want to prevent the AF points from rapidly tracking something that is not the intended subject during panning or when an obstacle cuts across the AF points.

- **Responsive: +1/+2/+3**

This makes the camera more responsive when tracking a subject that covers the AF point. The closer the setting is to the plus (+) symbol, the more responsive the camera is. It is effective when you want to keep tracking a moving subject as its distance from the camera changes or to rapidly focus on another subject.

#### Note

- Operation when inactive is equivalent to when set to [0].

## Selecting the Drive Mode

---

Single and continuous drive modes are provided. You can select the drive mode suiting the scene or subject.

---

1. Press the <M-Fn> button (ⓘ6).

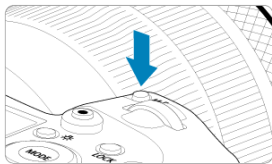

- With an image displayed on the screen, press the <M-Fn> button.

2. Select the drive mode item.



- Turn the <ⓘ6> dial to select the drive mode item.

### 3. Select the drive mode.



- Turn the <  > dial to make a selection.

-  **Single shooting**

When you hold down the shutter button completely, only one shot will be taken.

-  **High-speed continuous shooting +**

When you hold down the shutter button completely, you can shoot continuously at **max. approx. 12 shots/sec.** while you keep holding it down.

-  **High-speed continuous shooting**

When you hold down the shutter button completely, you can shoot continuously at **max. approx. 8.0 shots/sec.** ([: **Shutter mode**] set to [**Mechanical**]: **max. approx. 6.0 shots/sec.**) while you keep holding it down.

-  **Low-speed continuous shooting**

When you hold down the shutter button completely, you can shoot continuously at **max. approx. 3.0 shots/sec.** while you keep holding it down.

- [] **Self-timer: 10 sec./remote control**

- [] **Self-timer: 2 sec./remote control**

For self-timer shooting, see [Using the Self-Timer](#). For remote control shooting, see [Remote Control Shooting](#).

## Caution

- Approx. 12 shots/sec. continuous shooting speed with [ ] is available under the following conditions.
  - Room temperature (23°C/73°F)
  - Battery level (LP-E6NH): At least approx. 60% (or using an optional Battery Grip BG-R10, a battery level of at least approx. 60% with two LP-E6NH)
  - Shutter speed: 1/1000 sec. or faster
  - Wi-Fi connection: Not connected
  - Flicker reduction: None
  - Set to maximum aperture, when using RF lenses or [ ]-compatible EF lenses\*
    - \* For details on EF lenses compatible with [ ], refer to [EF Lenses Supporting 12 Shots/Sec. Continuous Shooting](#).
- Continuous shooting speed for [ ] and [ ] changes as follows in response to factors such as battery level, temperature, flicker reduction, shutter speed, aperture value, subject conditions, brightness, AF operation, type of lens, use of flash, and shooting settings.

(Approx. shots/sec.)

Icon Display		Green	White	White (Blinking)
[ ]		12	9.2	6.8
[ ]	For [Elec. 1st-curtain]	8.0	6.0	4.9
	For [Mechanical]	6.0	5.1	3.9

- Continuous shooting speed may become slower when using batteries with weak recharge performance ( ).
- Shooting continuously at up to approx. 12 shots/sec. is not possible using Wireless File Transmitter WFT-R10.
- Continuous shooting speed with Servo AF may be slower depending on subject conditions or the lens used.
- Continuous shooting speed may be lower when shooting under flickering light with [ : Anti-flicker shoot.] set to [Enable] ( ). Also, the continuous shooting interval may become irregular and the release time lag may become longer.
- When internal memory becomes full during continuous shooting, the continuous shooting speed may drop off because shooting will be temporarily disabled ( ).

# Using the Self-Timer

---

Use the self-timer when you want to be in the picture such as a commemorative photograph.

---

## 1. Press the <M-Fn> button (ⓘ6).

- With an image displayed on the screen, press the <M-Fn> button.

## 2. Select the drive mode item.



- Turn the <ⓘ6> dial to select the drive mode item.

## 3. Select the self-timer.



- Turn the <ⓘ6> dial to select the self-timer.

ⓘ6: Shoot in 10 sec.

ⓘ6: Shoot in 2 sec.

#### 4. Take the picture.

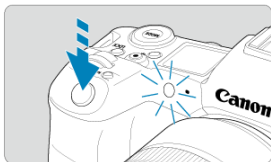

- Focus on the subject, then press the shutter button completely.
- To check operation, look at the self-timer lamp, listen for beeps, or watch the countdown in seconds on the screen.
- Self-timer lamp blinking accelerates and the camera beeps quickly approx. 2 sec. before the picture is taken.

#### Note

- [i] is used to start shooting without touching the camera (to avoid camera shake) when it is mounted on a tripod for shots such as still lifes or long exposures, for example.
- After taking self-timer shots, playing back the image (⏮) to check focus and exposure is recommended.
- When using the self-timer to shoot yourself, use focus lock (⏸) on an object at the same distance as where you will stand.
- To cancel the self-timer after it starts, either tap the screen or press < (SET) >.
- Auto power off time may be extended when the camera is set for remote control shooting.

## Remote Control Shooting

---

- ☑ [Remote Controller RC-6](#)
- ☑ [Wireless Remote Control BR-E1](#)
- ☑ [Remote Switch RS-80N3/TC-80N3](#)

For remote control shooting, you can use an optional Remote Controller RC-6 (infrared) or Wireless Remote Control BR-E1 (Bluetooth), or an optional Remote Switch RS-80N3 or Timer Remote Controller TC-80N3 (both wired).

---

### Remote Controller RC-6

---

You can shoot remotely up to approx. 5 meters/16.4 feet away from the front of the camera. You can either shoot immediately or with a 2-sec. delay.



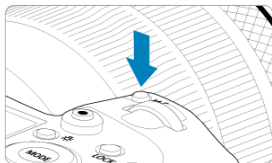

1. Press the <M-Fn> button (ⓘ6).



- With an image displayed on the screen, press the <M-Fn> button.

## 2. Select the self-timer/remote control.



- Turn the <  > dial to select the drive mode item, then turn the <  > dial to select [] or [].

## 3. Press the release (transmit) button on the remote controller.

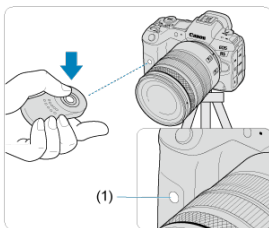

- Point the remote controller toward the camera's remote control sensor (1), then press the release (transmit) button.
- Autofocusing is performed when the focus mode switch is set to < AF >.
- The remote control lamp lights up, and the camera shoots.



 **Caution**

- Infrared remote controllers such as the RC-6 cannot be used for remote control shooting when the camera is paired via Bluetooth with a smartphone or wireless remote control.
- Fluorescent or LED lighting may trigger accidental shutter release. Try to keep the camera away from these light sources.
- Operating a TV remote control or similar device aimed at the camera may trigger accidental shutter release.
- Firing flash units of other cameras near the camera may trigger accidental shutter release. Do not expose the remote control sensor to flash fired by other cameras.

## Wireless Remote Control BR-E1

---

You can shoot remotely up to approx. 5 meters/16.4 feet from the camera. After pairing the camera and BR-E1 (🔗), set the drive mode to [i📷] or [i📷2] for still photo shooting (🔗). For movie recording, set [📷: Remote control] to [Enable]. For operating instructions, refer to the BR-E1 instruction manual.

### Note

#### RC-6 and BR-E1

- Auto power off time may be extended when the camera is set for remote control shooting.
- RC-6 and BR-E1 can also be used for movie recording (🔗).

## Remote Switch RS-80N3/TC-80N3

---

Once connected to the camera, the switch enables you to shoot remotely over a wired connection.

For operating instructions, refer to the accessory instruction manual.

1. **Open the terminal cover.**
2. **Connect the plug to the remote control terminal.**

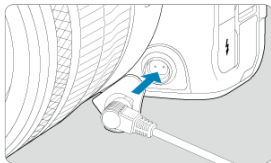

# Playback

---

This chapter covers topics related to playback—playing back captured still photos and movies—and introduces menu settings on the playback ([▶]) tab.

## Caution

- Normal display or selection on this camera may not be possible for images captured on other cameras, or images from this camera that have been edited or renamed on a computer.

- [Tab Menus: Playback](#)
- [Image Playback](#)
- [Magnified Image Display](#)
- [Index Display \(Multiple-Image Display\)](#)
- [Voice Memo Recording and Playback](#)
- [Movie Playback](#)
- [Editing a Movie's First and Last Scenes](#)
- [4K/8K Movie Frame Grab](#)
- [Playback on a TV Set](#)
- [Protecting Images](#)
- [Erasing Images](#)
- [Rotating Still Photos](#)
- [Changing Movie Orientation Information](#)
- [Rating Images](#)
- [Print Ordering \(DPOF\)](#)
- [Photobook Set-up](#)
- [Copying Images](#)
- [RAW Processing \(RAW/DPRAW\)](#)
- [DPRAW Processing](#)
- [Resizing JPEG/HEIF Images](#)
- [Cropping JPEG/HEIF Images](#)
- [Converting HEIF to JPEG](#)
- [Slide Show](#)
- [Setting Image Search Conditions](#)
- [Browsing Images with the Main Dial](#)
- [Switching the Main Dial and Quick Control Dial 2](#)
- [Rate/Voice Memo Button Function](#)
- [Customizing Playback Information Display](#)

- [Displaying the Highlight Alert](#)
- [AF Point Display](#)
- [Playback Grid](#)
- [Movie Play Count](#)
- [HDMI HDR Output](#)

## Tab Menus: Playback

---

### ● Playback 1

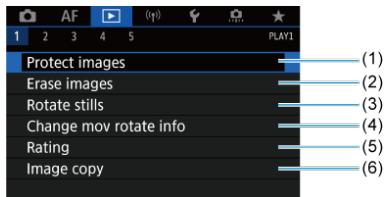

- (1) [Protect images](#)
- (2) [Erase images](#)
- (3) [Rotate stills](#)
- (4) [Change mov rotate info](#)
- (5) [Rating](#)
- (6) [Image copy](#)

### ● Playback 2

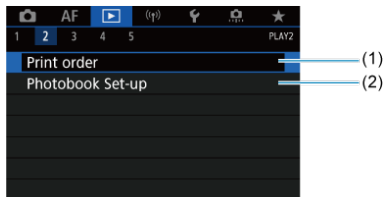

- (1) [Print order](#)
- (2) [Photobook Set-up](#)

### ● Playback 3

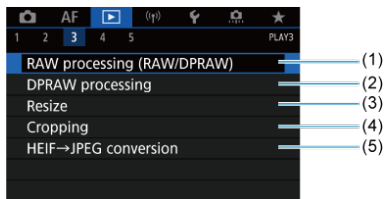

- (1) [RAW processing \(RAW/DPRAW\)](#)
- (2) [DPRAW processing](#)
- (3) [Resize](#)
- (4) [Cropping](#)
- (5) [HEIF→JPEG conversion](#)

#### ! Caution

- [▶]: [RAW processing \(RAW/DPRAW\)](#)], [▶]: [DPRAW processing](#)], and [▶]: [HEIF→JPEG conversion](#)] are not displayed in [A+] or [A+] mode.

### ● Playback 4

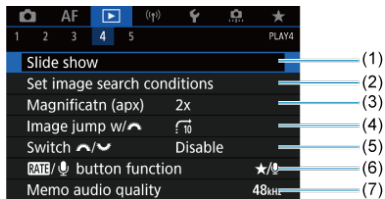

- (1) [Slide show](#)
- (2) [Set image search conditions](#)
- (3) [Magnificatn \(apx\)](#)
- (4) [Image jump w/ \[sun icon\]](#)
- (5) [Switch \[sun icon\] / \[moon icon\]](#)
- (6) [\[RATE\]/\[mic icon\] button function](#)
- (7) [Memo audio quality](#)

## ● Playback 5

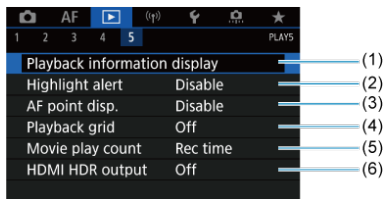

- (1) [Playback information display](#)
- (2) [Highlight alert](#)
- (3) [AF point disp.](#)
- (4) [Playback grid](#)
- (5) [Movie play count](#)
- (6) [HDMI HDR output](#)



# Image Playback

---

[Single-Image Display](#)

[Shooting Information Display](#)

[Touch Playback](#)

## Single-Image Display

---

### 1. Switch to playback.

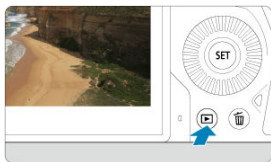

- Press the <  > button.
- The last image captured or played back is displayed.

## 2. Browse images.

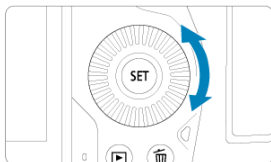

- To play back images starting with your most recent shot, turn the <  > dial counterclockwise. To play back images starting with the first captured image, turn the dial clockwise.
- Each time you press the < INFO > button, the display will change.

No information

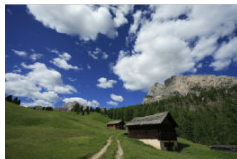

Basic information display

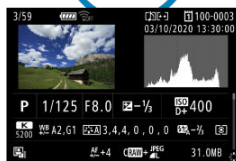

Shooting information display

## 3. Exit image playback.

- Press the <  > button to exit image playback and return to shooting standby.



#### Note

- Lines indicating the image area are shown on RAW images captured with [: **Cropping/aspect ratio**] set to [1:1 (aspect ratio)], [4:3 (aspect ratio)], or [16:9 (aspect ratio)] ([🔗](#)).
- If the search conditions are set with [: **Set image search conditions**] ([🔗](#)), only the filtered images will be displayed.

## Shooting Information Display

---

With the shooting information screen displayed (📷), you can press < ⌘ > up or down to view other information. You can also customize the information displayed, in [▶]: **Playback information display** (📷).

## Touch Playback

The camera features a touch-screen panel that you can touch to control playback. Supported touch operations are like those used with smartphones and similar devices. First, press the <  > button to prepare for touch playback.

### Browse images



### Jump display



### Index display

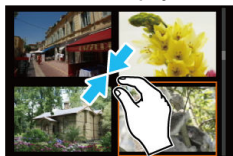

## Magnified view



### Note

- You can also magnify display by double-tapping with one finger.

# Magnified Image Display

## [Setting the Initial Magnification Ratio and Position](#)

You can magnify display of your captured images.





---

### 1. Magnify the image.



- Turn the <  > dial clockwise.



- The magnified view will appear. The position of the magnified area (1) is displayed in the lower right of the screen, along with [ Q].
- To magnify images, turn the <  > dial clockwise.
- To reduce magnification, turn the <  > dial counterclockwise. For index display () , keep turning the dial.

## 2. Scroll the image.

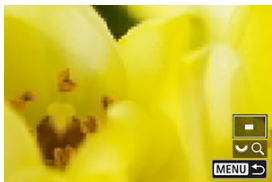
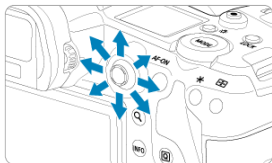

- Use < \* > to scroll around the magnified image.
- Press the < Q > or < MENU > button to exit magnified view.

### Note

- To switch to other images while maintaining magnified view, turn the <  > dial.
- Magnification is not available for movies.



## Setting the Initial Magnification Ratio and Position

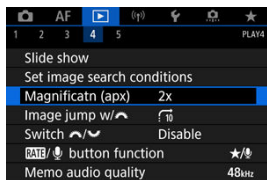

You can set the initial magnification ratio and magnified position by selecting [▶]: **Magnificatn (apx)**.

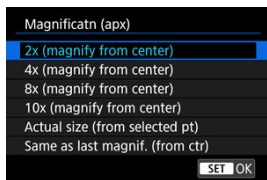

- **2x, 4x, 8x, 10x (magnify from center)**

The magnified view starts at the image center at the selected magnification ratio.

- **Actual size (from selected pt)**

The recorded image's pixels will be displayed at approx. 100%. The magnified view starts at the AF point that achieved focus. If the photo is taken with manual focus, the magnified view starts at the image center.

- **Same as last magnif. (from ctr)**

The magnification will be the same as the last time you exited the magnified view with the <▶> or <Q> button. The magnified view starts at the image center.

## Index Display (Multiple-Image Display)

---

### 1. Switch to the index display.



- During image playback, turn the <  > dial counterclockwise.

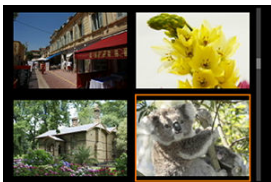

- The 4-image index display will appear. The selected image is highlighted with an orange frame.
- Turning the <  > dial further counterclockwise will switch the display from 9 to 36 to 100 images. Turning the dial clockwise cycles through 100, 36, 9, 4, and single-image display.

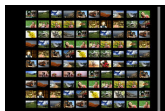
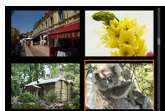

## 2. Browse images.



- Use < \* > or the < ⌚ > dial to move the orange frame for image selection.
- Press < SET > in the index display to display the selected image in the single-image display.

# Voice Memo Recording and Playback

---

 [Recording Voice Memos](#)

 [Memo Audio Quality](#)

 [Playing Voice Memos](#)

You can add (record) voice memos to your shots. Voice memos are recorded as WAV audio files with the same file number as the image. They can be played back by the camera or a computer.

---

## Recording Voice Memos

---

1. Switch to playback.
2. Select an image to add a voice memo to.
  - Turn the <  > dial to select an image to add a voice memo to.

### 3. Record a voice memo.

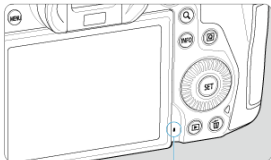
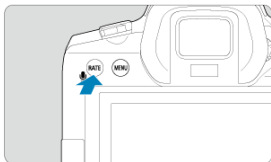

(1)



- Hold down the **<RATE>** button for approx. 2 sec.
- Keep holding down the **<RATE>** button after **[Recording memo...]** appears, and speak into the voice memo microphone (1). Each recording can be up to approx. 30 sec.
- To end the voice memo, release the button.
- A **[🎤]** icon is displayed at the top of the screen.

 **Caution**

- Voice memos cannot be added to movies or protected images.
- Voice memos cannot be recorded with an external microphone.

 **Note**

- Audio quality of voice memo recording can be changed in : **Memo audio quality**.
- To record voice memos longer than 30 sec., repeat step 3.
- You can record a single voice memo during image review (immediately after shooting) by following step 3.
- Even during transfer to an FTP server, you can add a voice memo to images from the playback screen. However, voice memos cannot be added to the image currently being transferred.

## Memo Audio Quality

You can set the audio quality for recording voice memos.

1. Select [▶: Memo audio quality].

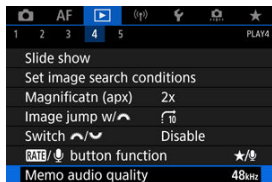

2. Select an option.

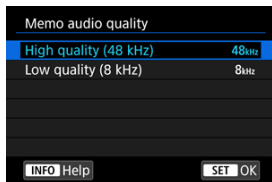

- **48 kHz: High quality (48 kHz)**  
Enables voice memo recording at the same level of audio quality as movies.
- **8 kHz: Low quality (8 kHz)**  
Enables smaller voice memo file sizes than with [High quality (48 kHz)].

### ⚠ Caution

- Additional voice memo recording for images with existing voice memos is performed at the same level of audio quality as the first recording, regardless of this setting.



1. Select [**▶**: **RATE**/**🎤** button function].

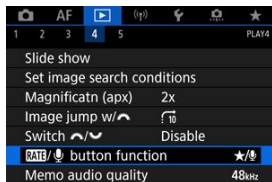

2. Select [**▶**: **Play memo(Hold:Rec. memo)**].

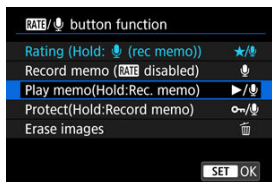

3. Select an image for voice memo playback.



- Press the < **▶** > button to switch to image playback.
- Turn the < **🎚** > dial to select an image labeled with a [**🎤**] icon at the top of the screen.

#### 4. Playback the voice memo.

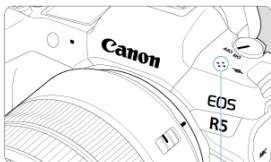
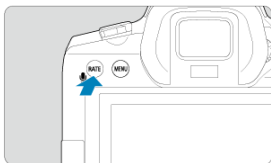

(1)

##### (1) Speaker

- Press the < **RATE** > button to play the voice memo.
- You can adjust the sound volume by turning the <  > dial.
- To stop playback, press the < **RATE** > button.

#### Note

- Multiple voice memos added to an image are played back consecutively.
- Added voice memos cannot be erased by themselves using the camera.
- Erasing images () also erases any voice memos added to the images.

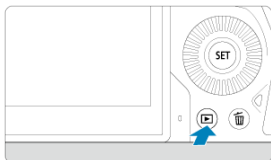

## 1. Switch to playback.





- Press the <  > button.

## 2. Select a movie.

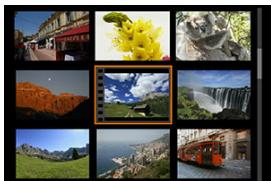

- Turn the <  > dial to select a movie to play.
- In single-image display, the [] icon displayed in the upper left of the screen indicates a movie.





- In index display, perforations at the left edge of a thumbnail indicate a movie. Movies cannot be played back from index display, so press <  > to switch to single-image display.

3. In the single-image display, press <  >.

4. Press <  > to play back the movie.



- The movie will start playing back.
- You can pause playback and display the movie playback panel by pressing <  >. Press it again to resume the playback.
- Turn the <  > dial to adjust the volume (even during playback).

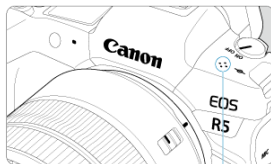

(1) Speaker

## Movie playback panel

Item	Playback Operations
Playback	Pressing <  > toggles between playback and stop.
Slow motion	Adjust the slow motion speed by turning the <  > dial. The slow motion speed is indicated in the upper right of the screen.
Skip backward	Skips backward approx. 4 sec. each time you press <  >.
Previous frame	Displays the previous frame each time you press <  >. Holding <  > down will rewind the movie.
Next frame	Plays the movie frame-by-frame each time you press <  >. Holding <  > down will fast forward the movie.
Skip forward	Skips forward approx. 4 sec. each time you press <  >.
Edit	Displays the editing screen ().
Frame Grab	Available when you play 8K or 4K movies. Enables you to extract the current frame and save it as a JPEG or HEIF still image ().
	Playback position
mm' ss"	Playback time (minutes:seconds, when [Movie play count] is set to [Rec time])
hh:mm:ss.ff (DF) hh:mm:ss:ff (NDF)	Time code (hours:minutes:seconds:frames, when [Movie play count] is set to [Time code])
Volume	Turn the <  > dial to adjust the volume of the built-in speaker () or headphones.
	Press the < MENU > button to return to single-image display.

### Caution

- Adjust the volume using television controls when the camera is connected to a television for movie playback () , because volume cannot be adjusted by turning the < > dial.
- Movie playback may stop if the card's read speed is too slow or movie files have corrupted frames.

## Editing a Movie's First and Last Scenes

---

You can edit out the first and last scenes of a movie in approx. 1-sec. increments.

---

1. In single-image display, press < **SET** >.



2. On the movie playback panel, select [**SC**].



### 3. Specify the part to be edited out.



- Select either [X] (Cut beginning) or [Y] (Cut end).



- Press < \* > left or right to go back or forward one frame. Keep pressing the multi-controller to fast rewind or fast forward frames. Each turn of the < ⦿ > dial goes back or forward one frame.
- After deciding which part to edit out, press < SET >. The portion indicated by a line at the bottom of the screen will remain.

### 4. Check the edited movie.



- Select [▶] to play back the edited movie.
- To change the edited part, go back to step 3.
- To cancel the editing, press the < MENU > button.

## 5. Save.

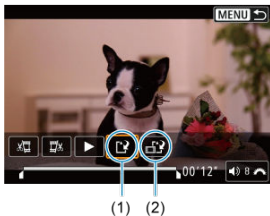

- Select **[⏏]** (1).
- The save screen will appear.
- To save it as a new file, select **[New file]**, or to save it and overwrite the original movie file, select **[Overwrite]**.  
Select **[⏏]** (2) to save a compressed version of the file. 4K and 8K movies are converted to Full HD movies before compression.
- On the confirmation screen, select **[OK]** to save the edited movie and return to the movie playback screen.

### ! Caution

- Because editing is performed in approx. 1 sec. increments (at the position indicated by **[⏏]** at the bottom of the screen), the actual position where movies are trimmed may differ from your specified position.
- Movies shot with another camera cannot be edited with this camera.
- You cannot edit a movie when the camera is connected to a computer.
- Compress and save is not available for movies recorded with **[HDR shooting HDR PQ]** set to **[Enable]** or **[Canon Log]** set to **[On]**, for movies recorded in **[FHD 29.97P [IPB]** (NTSC) or **[FHD 25.00P [IPB]** (PAL) sizes, or for **[4K-D/8K-D]** movies.











# 4K/8K Movie Frame Grab

From 4K or 8K movies, you can select individual frames to save as JPEG or HEIF still images. This function is called "Frame Grab."

## 1. Select a 4K or 8K movie.



- Turn the <  > dial to select a movie in 4K or 8K quality.
- On the shooting information screen () , 4K movies are labeled with , , and  icons, and 8K movies with  and  icons.
- In index display, press <  > to switch to single-image display.

## 2. In the single-image display, press < >.

- The movie playback panel will appear.

## 3. Select a frame to grab.



- Use the movie playback panel to select the frame to grab as a still image.
- For movie playback panel instructions, see [Movie playback panel](#).

4. Select [Frame Grab].



5. Save.



- Select [OK] to save the current frame as a JPEG still image. Frame grabs from HDR movie files are saved as HEIF images.
- Check the destination folder and image file number.

6. Select the image to display.

- Select [View original movie] or [View extracted still image].

**Caution**

- Frame grabbing is not possible from the following 4K movies, or from 8K movies.
  - RAW movies
  - Movies recorded with [📷: Canon Log settings] set to [On]
  - Movies recorded with other cameras
- Frame grabbing is not possible while the camera is connected to a computer.

## Playback on a TV Set

---

By connecting the camera to a television with a commercially available HDMI cable, you can play back the captured still photos and movies on the television.

If the image does not appear on the TV screen, confirm that [📺: Video system] is correctly set to [For NTSC] or [For PAL] (depending on the video system of your television).

---

### 1. Connect the HDMI cable to the camera.

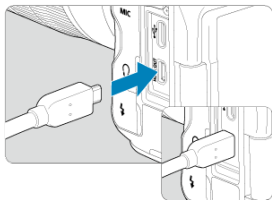

- Insert the HDMI cable in the camera's < **HDMI OUT** > terminal.

### 2. Connect the HDMI cable to the television.

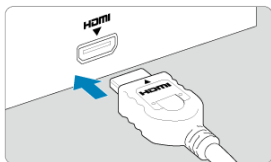

- Connect the HDMI cable to the television's HDMI IN port.

### 3. Turn on the television and switch the television's video input to select the connected port.

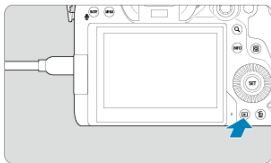

### 4. Set the camera's power switch to < ON >.

5. Press the <  > button.



- Images are now displayed on the television, with nothing displayed on the camera screen.
- The images will automatically be displayed at the optimum resolution matching the connected television.

 **Caution**

- Adjust movie sound volume with the television. The sound volume cannot be adjusted with the camera.
- Before connecting or disconnecting the cable between the camera and television, turn off the camera and television.
- Depending on the television, part of the image displayed may be cut off.
- Do not connect any other device's output to the camera's < **HDMI OUT** > terminal. Doing so may cause a malfunction.
- Certain televisions may not display the images due to incompatibility.
- It may take some time before images are displayed. To avoid delay, set [: **HDMI resolution**] to [**1080p**] ().
- Touch-screen operations are not supported while the camera is connected to a television.

## Protecting Images

---

[✔ Protecting Individual Images via the Menu](#)

[✔ Specifying the Range of Images to Protect](#)

[✔ Protecting All Images in a Folder or on a Card](#)

You can protect important images from being accidentally erased.

### ! Caution

- If you format the card (🗑️), the protected images will also be erased.

### 📄 Note

- Once an image is protected, it cannot be erased by the camera's erase function. To erase a protected image, you must first cancel the protection.
- If you erase all the images (🗑️), only the protected images will remain. This is convenient when you want to erase all unneeded images at once.

---

## Protecting Individual Images via the Menu

---

1. Select [📄: Protect images].

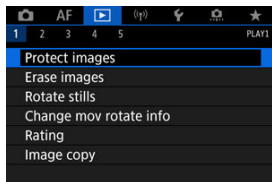

## 2. Select [Select images].

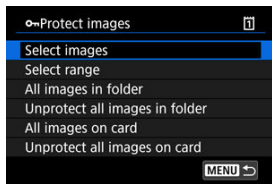





## 3. Select the image to protect.



- Turn the <  > dial to select an image to protect.

## 4. Protect the image.



- Press <  > to protect the selected image, after which it will be labeled with a  icon (1) at the top of the screen.
- To cancel protection and clear the  icon, press <  > again.
- To protect another image, repeat steps 3 and 4.

### Note

- You can protect individual images during playback by pressing the < **RATE** > button when [: **RATE**/ button function] is assigned to [**Protect(Hold:Record memo)**] ().

## Specifying the Range of Images to Protect

While looking at the images in the index display, you can specify the first and last images for a range to protect all the specified images at once.

### 1. Select [Select range].

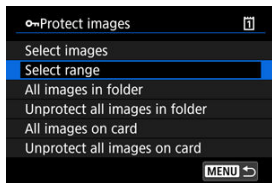

- Select [Select range] in [**1**]: Protect images].

### 2. Specify the range of images.



- Select the first image (start point).
- Next, select the last image (end point). The images in the specified range will be protected and the [**1**] icon will appear.
- To select another image to protect, repeat step 2.

## Protecting All Images in a Folder or on a Card

You can protect all the images in a folder or on a card at once.

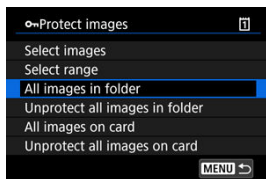

- When you select **[All images in folder]** or **[All images on card]** in **[▶]: Protect images**, all the images in the folder or on the card will be protected.
- To cancel protection, select **[Unprotect all images in folder]** or **[Unprotect all images on card]**.
- If the search conditions are set with **[▶: Set image search conditions]** (🔍), the display will change to **[All found images]** and **[Unprotect all found]**.

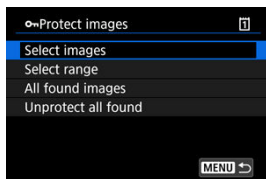

- If you select **[All found images]**, all the images filtered by the search conditions will be protected.
- If you select **[Unprotect all found]**, the protection of all the filtered images will be canceled.



## Erasing Images

---

- [Erasing Images Individually](#)
- [Selecting \(\[√\]\) Multiple Images to Erase Together](#)
- [Specifying the Range of Images to Erase](#)
- [Erasing All Images in a Folder or on a Card](#)

You can either select and erase unnecessary images individually or erase them in one batch. Protected images (🔒) will not be erased.

### ! Caution

- **Once an image is erased, it cannot be recovered. Make sure you no longer need the image before erasing it. To prevent important images from being erased accidentally, protect them.**

---

## Erasing Images Individually

---

1. Press the < ▶ > button.
2. Select the image to be erased.
  - Turn the < ⦿ > dial to select the image to erase.
3. Press the < 🗑 > button.

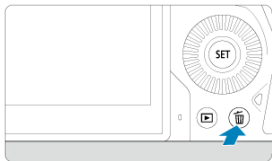

#### 4. Erase the images.

JPEG/HEIF/RAW images or movies

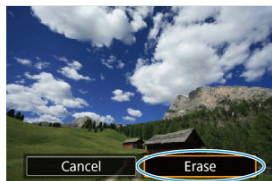

- Select [Erase].

RAW+JPEG/RAW+HEIF images



- Select an option.

#### Note

- You can erase individual images during playback by pressing the <RATE> button when [▶: RATE/🔊 button function] is assigned to [Erase images] (🔗).

## Selecting ([✓]) Multiple Images to Erase Together

By adding checkmarks to the images to be erased, you can erase all those images at once.

### 1. Select [▶]: Erase images].

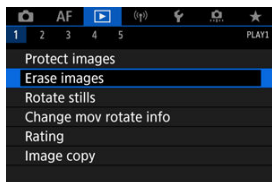

### 2. Select [Select and erase images].

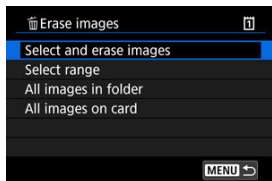

### 3. Select an image.



- Turn the <◉> dial to select an image to erase, then press <Ⓢ>.
- To select another image to be erased, repeat step 3.

#### 4. Erase the images.

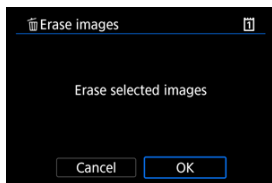

- Press the < [Q] > button, then press [OK].

## Specifying the Range of Images to Erase

While looking at the images in the index display, you can specify the first and last images for a range to erase all the specified images at once.

### 1. Select [Select range].

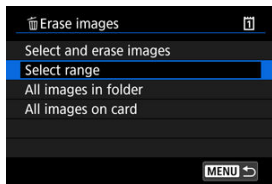

- Select [Select range] in [▶]: Erase images].

### 2. Specify the range of images.



- Select the first image (start point).
- Next, select the last image (end point). A checkmark [✓] will be appended to all the images within the range between first and last images.
- To select another image to be erased, repeat step 2.

### 3. Press the <Q> button.

#### 4. Erase the images.

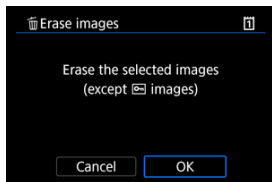

- Select **[OK]**.

## Erasing All Images in a Folder or on a Card

You can erase all the images in a folder or on a card at once.

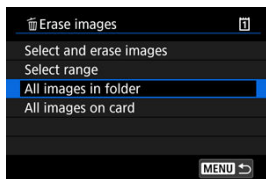

- When you select **[All images in folder]** or **[All images on card]** in **[▶]: Erase images**, all the images in the folder or on the card will be erased.
- If the search conditions are set with **[▶]: Set image search conditions** (🔗), the display will change to **[All found images]**.

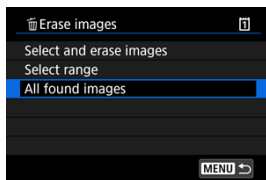

- If you select **[All found images]**, all the images filtered by the search conditions will be erased.

### Note

- To erase all the images including protected images, format the card (🔗).

# Rotating Still Photos

---

You can use this feature to rotate the displayed image to the desired orientation.

---

1. Select [▶]: Rotate stills].

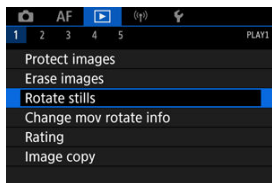

2. Select an image to rotate.

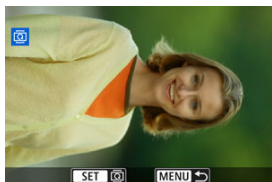

- Turn the <⦿> dial to select the image.





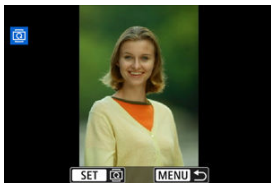

### 3. Rotate the image.



- Each time you press < **SET** >, the image will rotate clockwise as follows: 90°→270°→0°.
- To rotate another image, repeat steps 2 and 3.

#### Note

- If you set [**F**: **Auto rotate**] to [**On**  ] () before taking pictures, you need not rotate the image with this function.
- If the rotated image is not displayed in the rotated orientation during image playback, set [**F**: **Auto rotate**] to [**On**  ].
- Movies cannot be rotated.

# Changing Movie Orientation Information

---

You can manually edit movie playback orientation information (which determines which side is up).

---

1. Select []: Change mov rotate info].

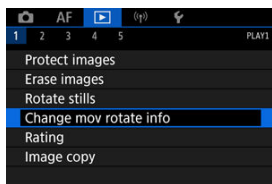



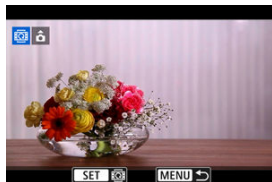



2. Select a movie.

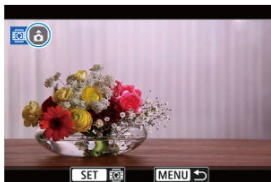



- Turn the <  > dial to select a movie with orientation information to change.

### 3. Change the orientation information.



- As you watch the camera and  icon in the upper left of the screen, press <  > to specify which side is up. Each press of <  > edits the movie rotation information as follows: [] → [] → [].

#### Caution

- Movies are played horizontally on the camera and via HDMI video output, regardless of the [: **Add  rotate info**] setting ().
- Movie orientation information of movies recorded with other cameras cannot be edited with this camera.

# Rating Images

---

[Rating Individual Images With the < RATE > Button](#)

[Rating Individual Images via the Menu](#)

[Rating by Specifying the Range](#)

[Rating All Images in a Folder or on a Card](#)

You can rate images on a scale of 1–5 ([\*]/[\* \*]/[\* \* \*]/[\* \* \* \*]/[\* \* \* \* \*]). This function is called rating.



\* Rating images can help you organize them.

---

## Rating Individual Images With the < RATE > Button

---

### 1. Select the image to be rated.

- Press the <  > button to switch to image playback.
- Turn the <  > dial to select the image to be rated.



### 2. Rate the image.



- Press the < **RATE** > button to rate the image, after which a message is displayed on the screen.
- To rate another image, repeat steps 1 and 2.



## Note

- In the detailed settings for **[Rating (Hold:  (rec memo))]** in **[: **RATE**/ button function]**, you can select the rating to apply.

## Rating Individual Images via the Menu

1. Select [▶]: Rating.

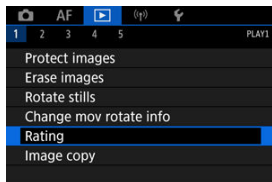

2. Select [Select images].

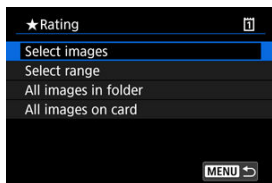

3. Select the image to be rated.

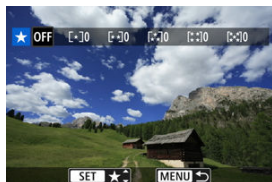

- Turn the <◉> dial to select the image to be rated.

#### 4. Rate the image.

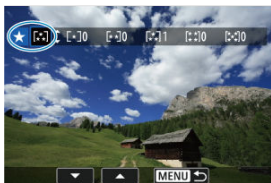

- Press  $\langle \text{SET} \rangle$ , and a blue highlight frame will appear as shown in the screen shown above.
- Turn the  $\langle \text{DIAL} \rangle$  dial to select a rating mark, then press  $\langle \text{SET} \rangle$ .
- When you append a rating mark to the image, the number beside the set rating will increase by one.
- To rate another image, repeat steps 3 and 4.

## Rating by Specifying the Range

While looking at the images in the index display, you can specify the first and last images for a range to rate all the specified images at once.

### 1. Select [Select range].

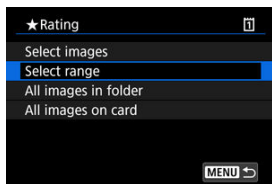

- Select [Select range] in [ ]: Rating.

### 2. Specify the range of images.

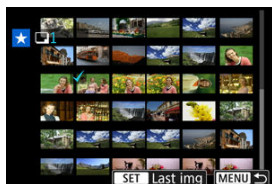

- Select the first image (start point).
- Next, select the last image (end point).  
A checkmark [✓] will be appended to all the images within the range between first and last images.

### 3. Press the < [Q] > button.



## 4. Rate the images.



- Turn the <  > dial to select a rating mark, then select **[OK]**. All the images in the specified range will be rated (same rating) at once.

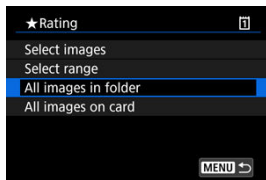

## Rating All Images in a Folder or on a Card

You can rate all the images in a folder or on a card at once.



- Under [  : **Rating** ], when you select [**All images in folder**] or [**All images on card**], all the images in the folder or on the card will be rated.



- Turn the <  > dial to select a rating, then select [**OK**].
- When you are not rating images or canceling the rating, select [**OFF**].
- If the search conditions are set with [  : **Set image search conditions** ] (  ), the display will change to [**All found images**].

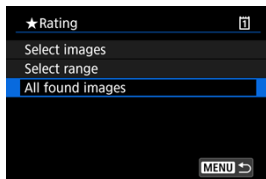

- If you select [**All found images**], all the images filtered by the search conditions will be rated as specified.



#### Note

- Values next to ratings are displayed as [###] if more than 1,000 images have that rating.
- With [▶]: **Set image search conditions**] and [▶]: **Image jump w/🌅**], you can display only the images given a specific rating.

## Copying Images

---



 [Copying Individual Images](#)

 [Copying a Range of Images](#)

 [Copying All Images in a Folder or on a Card](#)

You can copy the images on one card to the other card to save duplicates.  
All images in a folder or on a card can also be copied at the same time.

### Caution

- If the target folder or card already has an image with the same file number, **[Skip image and continue]**, **[Replace existing image]**, and **[Cancel copy]** are displayed. Select a copying method, then press <  >.
  - **[Skip image and continue]**: Any images with the same file number are skipped and not copied.
  - **[Replace existing image]**: Any images with the same file number (including protected images) are overwritten.Overwriting images that had print order information () will require you to set the print order information again.
- Print order and image transfer information is not included in copies of images.
- Shooting is not possible during the copying process. Select **[Cancel]** before shooting.

### Note

- Copies of images have the same file name as the original image.
- With **[Sel. Image]**, images in multiple folders cannot be copied at the same time. Select images to copy from one folder at a time.
- Any voice memos added to images are also copied.

## Copying Individual Images

1. Select [**▶**]: Image copy].

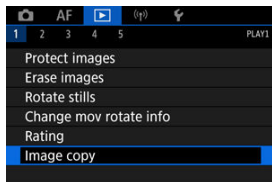

2. Select [**Sel.Image**].

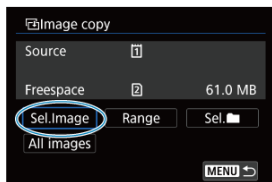

- Check the source and target card numbers and the free space on the target card.
- Select [**Sel.Image**], then press < **SET** >.

### 3. Select the folder.

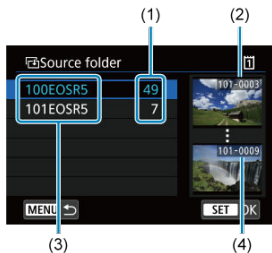

- (1) Number of images in folder
- (2) Lowest file number
- (3) Folder name
- (4) Highest file number

- Select the source folder, then press  $\langle \text{SET} \rangle$ .
- When selecting the folder, refer to the images displayed at right of the screen.

### 4. Select an image to copy.



- (1) Total images selected

- Turn the  $\langle \text{DIAL} \rangle$  dial to select an image to copy, then press  $\langle \text{SET} \rangle$ .
- To select another image to copy, repeat step 4.

5. Press the <Q> button.

6. Select [OK].

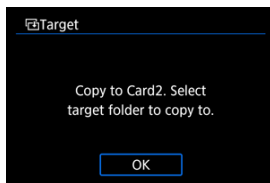

- Check the target card, then select [OK].

7. Select the target folder.

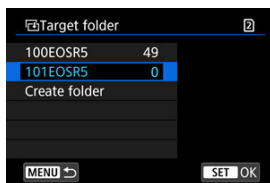

- Select the folder to copy the image to, then press <SET>.
- To create a new folder, select [Create folder].

## 8. Select [OK].

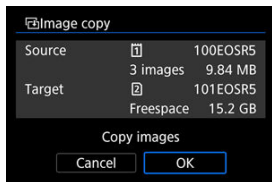

- Check the information about the source and target card, then select [OK].

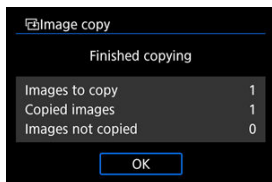

- Results are displayed after copying is finished. Select [OK] to return to the screen in step 2.



## Copying a Range of Images

You can copy all specified images at once by selecting the first and last images in a range as you look at images in the index display.

### 1. Select [Range].

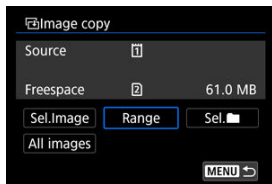

### 2. Select the folder.

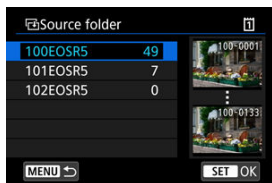

- Select the source folder, then press < (SET) >.
- When selecting the folder, refer to the images displayed at right of the screen.

### 3. Specify the range of images.



- Select the first image (start point).
- Next, select the last image (end point). A checkmark [✓] will be appended to all the images within the range between first and last images.
- To select another image to copy, repeat step 3.

## Copying All Images in a Folder or on a Card

---

You can copy all the images in a folder or on a card at once.

Selecting [Sel. : Image copy] copies all the images it contains.

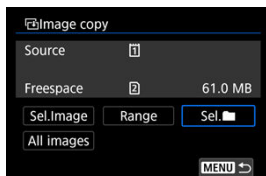

# Print Ordering (DPOF)

---

 [Print Options](#)

 [Selecting Images for Printing](#)

DPOF (Digital Print Order Format) enables you to print images recorded on the card according to your printing instructions such as the image selection, quantity to print, etc. You can print multiple images in one batch or create a print order for a photofinisher.

You can set the print settings such as print type, date imprinting, file number imprinting, etc. The print settings will be applied to all the images specified for printing. (They cannot be set individually for each image.)

---

## Print Options

---

1. Select [: Print order].

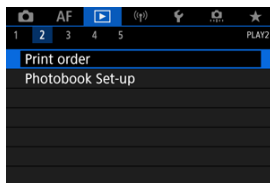

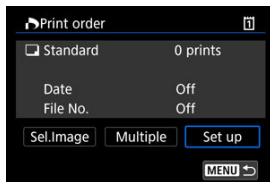

2. Select [Set up].



### 3. Set the options as desired.

- Set **[Print type]**, **[Date]**, and **[File No.]** options.

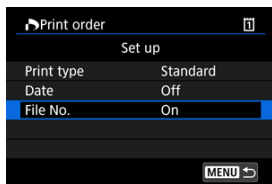

<b>Print type</b>	 <b>Standard</b>	Prints one image on one sheet.
	 <b>Index</b>	Multiple thumbnail images are printed on one sheet.
	 <b>Both</b>	Prints both the standard and index prints.
<b>Date</b>	<b>On</b>	[On] imprints the recorded date of the captured image.
	<b>Off</b>	
<b>File No.</b>	<b>On</b>	[On] imprints the file number.
	<b>Off</b>	

### 4. Exit the setting.



- Press the < **MENU** > button.
- Next, select **[Sel.Image]** or **[Multiple]** to specify the images to be printed.

## Caution

- If you print an image with a large image size using the **[Index]** or **[Both]** setting () , the index print may not be printed with certain printers. In this case, resize the image () , then print the index print.
- Even if **[Date]** and **[File No.]** are set to **[On]**, the date or file number may not be imprinted, depending on the print type setting and printer.
- With **[Index]** prints, the **[Date]** and **[File No.]** cannot both be set to **[On]** at the same time.
- When printing with DPOF, use the card for which print order specifications are set. You cannot print in the specified print order if you extract just the images from the card for printing.
- Certain DPOF-compliant printers and photofinishers may not be able to print the images as you specified. When using a printer, refer to the printer's instruction manual. When requesting service from a photofinisher, ask in advance.
- Do not use this camera to configure print settings for images with DPOF settings set up on another camera. All the print orders may be overwritten inadvertently. Also, the print order may not be possible, depending on the image type.

## Selecting Images for Printing

### Sel.Image

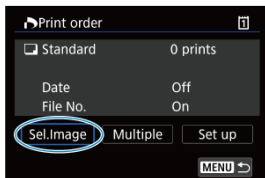

Select and specify the images individually.

Press the < MENU > button to save the print order to the card.

#### ● Standard/Both



Press < SET > to print a copy of the displayed image. By turning the < dial >, you can set a print quantity of up to 99 copies.

#### ● Index

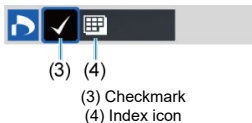

Press < SET > to add a checkmark [✓] to the box. The image will be included in the index print.

## Multiple

- **Select range**

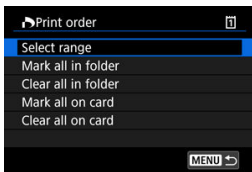

Select **[Select range]** in **[Multiple]**. Selecting the first and last images of the range marks all the images in the range with a checkmark [✓], and one copy of each image will be specified for printing.

- **All images in a folder**

Select **[Mark all in folder]** and select the folder. A print order for one copy of all the images in the folder will be specified.

If you select **[Clear all in folder]** and select the folder, the print order for all the images in the folder will be canceled.

- **All images on a card**

If you select **[Mark all on card]**, one copy of all the images on the card will be specified for printing.

If you select **[Clear all on card]**, the print order will be cleared for all the images on the card.

If the search conditions are set with [▶]: **Set image search conditions** (🔍) and you select **[Multiple]**, the display will change to **[Mark all found images]** and **[Clear all found images]**.

- **All found images**

If you select **[Mark all found images]**, one copy of all the images filtered by the search conditions will be specified for printing.

If you select **[Clear all found images]**, all the print order of the filtered images will be cleared.

### ⚠ Caution

- RAW images or movies cannot be specified for printing. Note that RAW images or movies will not be specified for printing even if you specify all images with **[Multiple]**.



# Photobook Set-up

---

- [Specifying Individual Images via the Menu](#)
- [Specifying the Image Range for a Photobook](#)
- [Specifying All Images in a Folder or Card](#)

You can specify up to 998 images to be printed in a photobook. When you use EOS Utility (EOS software) to import images to a computer, the specified images for a photobook will be copied to a dedicated folder. This function is useful for ordering photobooks online.

---

## Specifying Individual Images via the Menu

---

1. Select []: Photobook Set-up].

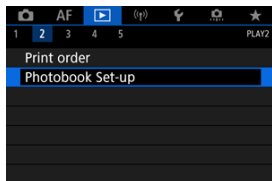

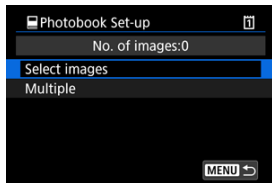

2. Select [Select images].



### 3. Select the image to be specified.



- Use the <  > dial to select the image to be specified for a photobook, then press <  >.
- To select other images to be specified for a photobook, repeat step 3.

## Specifying the Image Range for a Photobook

While looking at the images in the index display, you can specify the range (start point to end point) of images to be specified for a photobook at once.

### 1. Select [Multiple].

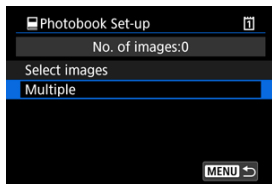

- Select [Multiple] in [▶]: Photobook Set-up.

### 2. Select [Select range].

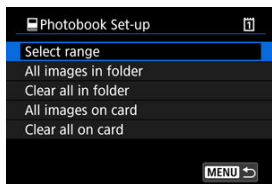

### 3. Specify the range of images.



- Select the first image (start point).
- Next, select the last image (end point).

A checkmark [✓] will be appended to all the images within the range between first and last images.

## Specifying All Images in a Folder or Card

You can specify all the images in a folder or on a card at once for a photobook.

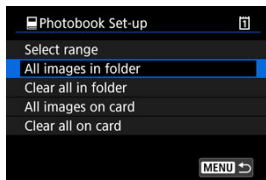

All images in the folder or on the card are specified for the photobook when you select [**All images in folder**] or [**All images on card**] in the [**Multiple**] option for [**▶**]: **Photobook Set-up**].

To clear selection, select [**Clear all in folder**] or [**Clear all on card**].

If the search conditions are set with [**▶**]: **Set image search conditions**] (**🔍**) and you select [**Multiple**], the display will change to [**All found images**] and [**Clear all found images**].

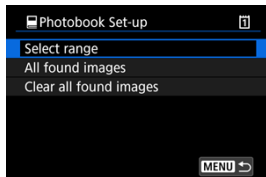

[**All found images**]: All images filtered by the search conditions are specified for the photobook.

[**Clear all found images**]: Clears photobook designation of all filtered images.

### ! Caution

- RAW images or movies cannot be specified for the photobook. Note that RAW images or movies will not be specified for the photobook even if you specify all images with [**Multiple**].
- Do not use this camera to configure photobook settings for images with photobook settings set up on another camera. All the photobook settings may be overwritten inadvertently.

# RAW Processing (RAW/DPRAW)

---

[Magnified View](#)

[Processing Images with Specified Aspect Ratios](#)

[RAW Image Processing Options](#)

You can process **RAW** or **CRRAW** images with the camera to create JPEG or HEIF images. RAW images are not affected, so different conditions can be applied to create JPEG or HEIF images.

You can also use Digital Photo Professional (EOS software) to process RAW images.

## Caution

- Processing into HEIF is not available for **RAW** or **CRRAW** images captured with multiple exposure, expanded ISO speed (L or H), or electronic shutter selected.

1. Select []: RAW processing (RAW/DPRAW)].

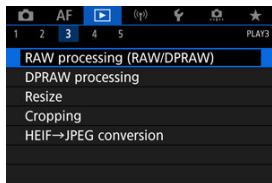



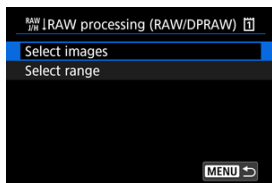

## 2. Select an option, then select images.

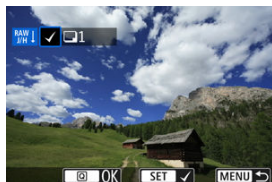

- You can select multiple images to process at once.



### Select images



- Turn the <  > dial to select images to process, then press <  >.
- Press the <  > button.

### Select range



- Select the first image (start point).
- Next, select the last image (end point). A checkmark [] will be appended to all the images within the range between first and last images.
- Press the <  > button.
- To process other images, repeat this step.

### 3. Set the desired processing conditions.

#### Use shot settings

- Images are processed using image settings at the time of capture.
- Images captured with [CAMERA: HDR PQ settings] set to [Enable] are processed to create HEIFs, and images captured with this function set to [Disable] are processed to create JPEGs.

#### Set up processing → JPEG/Set up processing → HEIF



- Use < > to select an item.
- Turn the < > or < > dial to switch the setting.
- Press < > to access the function setting screen.
- To return to the image settings at the time of shooting, press the < > button.

#### Comparison screen

- You can switch between the [After change] and [Shot settings] screens by pressing the < INFO > button and turning the < > dial.
- Items in orange on the [After change] screen have been modified since the time of capture.
- Press the < MENU > button to return to the processing conditions screen.



#### 4. Save.

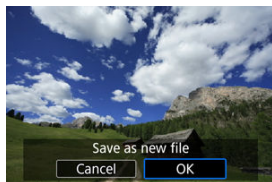

- When using **[Set up processing→JPEG]** or **[Set up processing→HEIF]**, select **[S]** (Save).
- Read the message and select **[OK]**.
- To process other images, select **[Yes]** and repeat steps 2–4.

#### 5. Select the image to display.



- Select **[Original image]** or **[Processed img.]**.
- Your selected image is displayed.

## Magnified View

---



You can magnify images displayed for **[Set up processing→JPEG]** or **[Set up processing→HEIF]** by pressing the **< Q >** button. The magnification ratio varies depending on the **[Image quality]** setting. With **< \* >**, you can scroll around the magnified image. To cancel the magnified view, press the **< Q >** button again.

 **Caution**

- Results of processing with **[Digital Lens Optimizer]** set to **[High]** are only applied in magnified view. Results are not applied in normal display.

## Processing Images with Specified Aspect Ratios

---



JPEG or HEIF images at the specified aspect ratio are created when you process RAW images shot with [: Cropping/aspect ratio] () set to [1:1 (aspect ratio)], [4:3 (aspect ratio)], or [16:9 (aspect ratio)].

## RAW Image Processing Options

-   $\pm 0$  **Brightness adjustment**





You can adjust the image brightness up to  $\pm 1$  stop in 1/3-stop increments.

-  **White balance** 

You can select the white balance. Selecting  enables you to select **[Auto: Ambience priority]** or **[Auto: White priority]**. If you select , you can set the color temperature.

-  **Picture Style** 



You can select the Picture Style. You can adjust the sharpness, contrast, and other parameters.

\* , , , and  are not available when **[Set up processing]→HEIF** is set.

-   $\pm 0$  **Clarity** 

You can adjust clarity in a range of  $-4$  to  $+4$ .

\* Not available when **[Set up processing]→HEIF** is set.

-  **Auto Lighting Optimizer**  +  **Adj face lighting**

You can specify Auto Lighting Optimizer details. With automatic, optimal adjustment of lighting on faces, you can effectively correct images captured with oblique lighting or illuminated by flash.

\* Not available when **[Set up processing]→HEIF** is set.

### Caution

#### When adjustment of face lighting is set

- Suitable adjustment may not be possible in some shooting situations unless faces can be detected in detail and are not too dark.
- Noise may increase.
- Adjustment may be less effective at high ISO speeds.

-  **High ISO speed NR** 

You can set the noise reduction processing for high ISO speeds. If the effect is difficult to discern, magnify the image .

## ● Image quality

You can set the image quality when creating a JPEG or HEIF image.



## ● sRGB Color space

You can select either sRGB or Adobe RGB. Since the camera screen is not compatible with Adobe RGB, the difference in the image will hardly be perceptible when either color space is set.

\* **[HDR PQ]** is displayed when **[Set up processing→HEIF]** is set but is not an option for selection.

## ● Lens aberr correction

### • OFF **Peripheral illum corr**

A phenomenon that makes the image corners look darker due to the lens characteristics can be corrected. If **[Enable]** is set, the corrected image will be displayed. If the effect is difficult to discern, magnify the image  and check the four corners. Less correction is applied than for maximum correction with Digital Photo Professional (EOS software, ). If the effects of correction are not apparent, use Digital Photo Professional to apply the peripheral illumination correction.

### • OFF **Distortion correction**

Image distortion due to lens characteristics can be corrected. If **[Enable]** is set, the corrected image will be displayed. The image periphery will be trimmed in the corrected image.

Since the image resolution may look slightly lower, adjust the sharpness with the Picture Style's sharpness parameter setting as necessary.

### • OFF **Digital Lens Optimizer**

Correct lens aberration, diffraction, and low-pass filter-induced loss of resolution by applying optical design values. To check the effect of setting this option to **[High]** or **[Standard]**, use magnified view . Without magnification, the effect when Digital Lens Optimizer is set to **[High]** is not applied. Selecting **[High]** or **[Standard]** corrects both chromatic aberration and diffraction, although these options are not displayed.

### • OFF **Chromatic aberr corr**

Chromatic aberrations (color fringing along the subject's outline) due to the lens characteristics can be corrected. If **[Enable]** is set, the corrected image will be displayed. If the effect is difficult to discern, magnify the image .

•  OFF **Diffraction correction** ()

The diffraction by the lens aperture degrading the image sharpness can be corrected. If **[Enable]** is set, the corrected image will be displayed. If the effect is difficult to discern, magnify the image () .

 **Caution**

- Processing RAW images in the camera will not produce exactly the same results as processing RAW images with Digital Photo Professional (EOS software).
- If you perform **[Brightness adjustment]**, noise, banding, etc. may be intensified with the effects of adjustment.
- When **[Digital Lens Optimizer]** is set, noise may be intensified together with the effects of correction.
- When **[Digital Lens Optimizer]** is set, image edges may be emphasized, under some shooting conditions. Adjust sharpness of the Picture Style as needed.
- Processing with **[Digital Lens Optimizer]** set to **[High]** may take some time.

 **Note**

- Effects of lens aberration correction vary by lens and by shooting conditions. Also, the effect may be difficult to discern depending on the lens used, shooting conditions, etc.
- RAW movies cannot be processed. Process them with Digital Photo Professional (EOS software).

# DPRAW Processing

---

[Portrait Relighting](#)

[Background Clarity](#)

When you use the camera in RAW image processing (📷) for images captured with Dual Pixel RAW enabled (📷), dual pixel data and detailed face information can be used in image correction.

---

## Portrait Relighting

---

Oblique or insufficient lighting on human subjects can be corrected by applying a virtual light source.

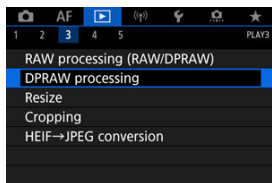

Unlike the Auto Lighting Optimizer feature that adjusts lighting in the face area automatically, portrait relighting is for manual adjustment of lighting. You can apply correction to the face as well as the body and other areas.

1. Select [▶]: DPRAW processing].

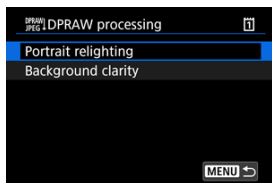

## 2. Select [Portrait relighting].



- Turn the <  > dial to select an image to adjust, then press <  >.



### 3. Adjust the image.



- Select [OFF], then press <SET>.



- Adjust the image, then press <SET>.
  - (1) Use <☼> to position the light source.
  - (2) represents the position of the selected face. By adjusting (1) relative to (2), you can adjust the direction of lighting. Overlapping positions of (1) and (2) place the light source directly in front of the face. You can also drag to adjust the direction of lighting.
  - (3) To set the light intensity (☼low/☼standard/☼high), press the <Q> button.
  - (4) To set the light coverage (☼spot/☼medium/☼wide), press the <Q> button.
  - (5) For images with multiple human subjects, you can press the <RATE> button and turn the <☼> dial to select a face for adjustment before you specify processing conditions. You can also tap the screen to select a face.

## Comparison screen

- You can switch between the **[After change]** and **[Shot settings]** screens by pressing the **[INFO]** button, then turning the <  > dial.
- Items in orange on the **[After change]** screen have been modified since the time of capture.

### Caution

- Selection is possible from up to 10 people.
- Faces cannot be selected unless they are large enough and away from the edge of the screen, and the camera must be able to acquire detailed face information.

## 4. Save.

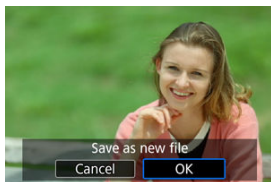

- Select **[S]** (Save), read the message, and select **[OK]**.

## Background Clarity

To adjust hazy backgrounds in images of people and landscapes, you can set the level of clarity in a range of 0–4.

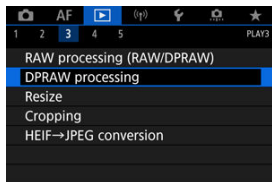

For clarity adjustment in RAW image processing, you can set the level of image edge contrast in a range of -4 to +4.

1. Select [▶]: DPRAW processing].

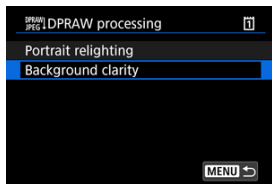

2. Select [Background clarity].



- Turn the <  > dial to select an image to adjust, then press <  >.

### 3. Adjust the image.



- Select  $\langle \text{▲} 0 \rangle$ , then press  $\langle \text{SET} \rangle$ .
- With  $\langle \text{▲} 0 \rangle$  selected, you can select the level by turning the  $\langle \text{☀} \rangle$  or  $\langle \text{🕒} \rangle$  dial without pressing  $\langle \text{SET} \rangle$ .

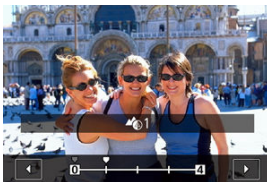

- Turn the  $\langle \text{☀} \rangle$  or  $\langle \text{🕒} \rangle$  dial to select the level, then press  $\langle \text{SET} \rangle$ .

#### Comparison screen

- You can switch between the **[After change]** and **[Shot settings]** screens by pressing the **[INFO]** button, then turning the  $\langle \text{🕒} \rangle$  dial.
- Items in orange on the **[After change]** screen have been modified since the time of capture.

## 4. Save.

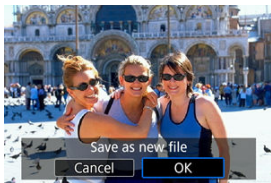

- Select **[S]** (Save), read the message, and select **[OK]**.

### Note

- For settings other than **[Portrait relighting]** and **[Background clarity]**, you can specify processing based on setting items of **[RAW image processing]** .

### Caution

#### Portrait relighting and background clarity

- HEIF images cannot be processed this way.
- Magnified view is not available during adjustment.
- Images for which the camera could not acquire detailed face information cannot be selected. When shooting, try to ensure that faces are large enough and near the center of the screen.
- Portrait relighting and background clarity cannot be used together.

#### Portrait Relighting

- Images are displayed horizontally even if shot in vertical orientation.
- Results of processing may differ from the preview. Check images after processing.
- If areas other than the selected subject are adjusted, this can be reduced by narrowing the adjustment area.
- Adjustment may be applied to other subjects near the selected subject. This can be reduced by narrowing light source coverage.

#### Background Clarity

- Background clarity is less effective for images with significant background blurring. To control the amount of background blurring, see [Av: Aperture-Priority AE](#).
- Fringing may appear on subjects that include adjacent bright and dark areas. This can be avoided by reducing the level of adjustment.
- Areas other than the background may also be adjusted.

## Resizing JPEG/HEIF Images

---

You can resize a JPEG or HEIF image to reduce the pixel count and save it as a new image. Resizing is available for **L**, **M**, or **S1** JPEGs or HEIFs (sizes except **S2**), including those captured in RAW+JPEG and RAW+HEIF shooting. **S2** images and RAW images or movies cannot be resized.

---

1. Select [**▶**]: Resize].

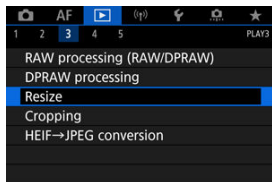

2. Select an image.

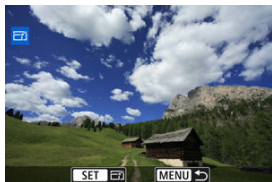

- Turn the <  > dial to select the image to resize.

### 3. Select the desired image size.

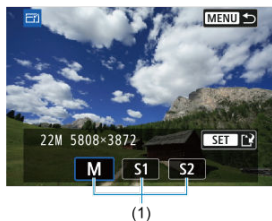

- Press < **SET** > to display the image sizes.
- Select the desired image size (1).

### 4. Save.

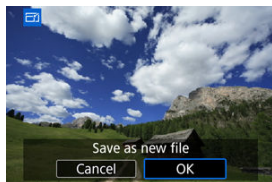

- Select [**OK**] to save the resized image.
- Check the destination folder and image file number, then select [**OK**].
- To resize another image, repeat steps 2 to 4.

# Cropping JPEG/HEIF Images

---

You can crop a captured JPEG image and save it as another image. Cropping is available for JPEG or HEIF images. RAW images and frame-grab images from 4K or 8K movies cannot be cropped.

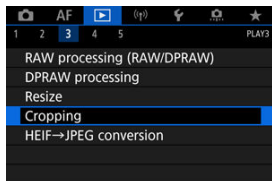

---

## 1. Select [ ]: Cropping].

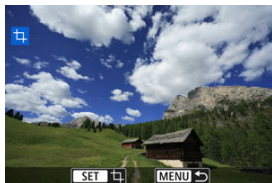

## 2. Select an image.









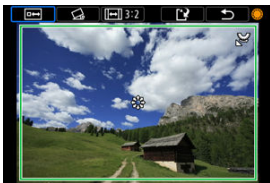



- Turn the <  > dial to select the image to crop.
- Press <  > to display the cropping frame.





### 3. Set the cropping frame.



- The image area within the cropping frame will be cropped.
- **Resizing the cropping frame size**  
Turn the <  > dial to resize the cropping frame size. The smaller the cropping frame, the more magnified the cropped image will look.
- **Correcting tilt**  
You can correct image tilt by  $\pm 10^\circ$ . Turn the <  > dial to select [], then press <  >. While checking tilt relative to the grid, turn the <  > dial (in  $0.1^\circ$  increments) or tap the left or right arrow (in  $0.5^\circ$  increments) in the upper left of the screen to correct tilt. After completing the tilt correction, press <  >.
- **Changing the cropping frame aspect ratio and orientation**  
Turn the <  > dial and select []. Each press of <  > changes the cropping frame aspect ratio.
- **Moving the cropping frame**  
Use <  > to move the cropping frame vertically or horizontally.



### 4. Check the image area to be cropped.





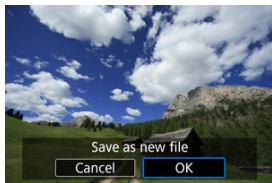

- Turn the <  > dial to select [], then press <  >. The image area to crop is displayed.

## 5. Save.



- Turn the <  > dial to select [>], then press <  >.
- Select [**OK**] to save the cropped image.
- Check the destination folder and image file number, then select [**OK**].
- To crop another image, repeat steps 2 to 5.

### Caution

- The position and size of the cropping frame may change depending on the angle set for tilt correction.
- Once a cropped image is saved, it cannot be cropped again or resized.
- AF point display information () and Dust Delete Data () will not be appended to the cropped images.
- Available aspect ratios vary depending on whether you use []: **Cropping**] or []: **Add cropping information**].

# Converting HEIF to JPEG

---

You can convert HEIF images captured in HDR shooting and save them as JPEG images.

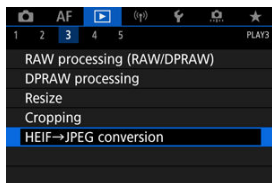

---

1. Select []: HEIF→JPEG conversion].

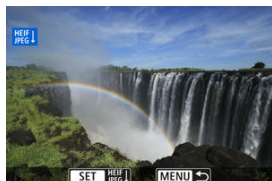

2. Select an image.



- Turn the < > dial to select an HEIF image to convert to JPEG.
- Press < > to convert to JPEG.

### 3. Save.

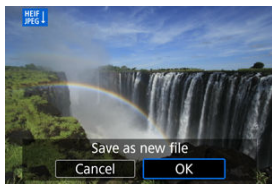

- Select **[OK]** to save the JPEG image.
  - Check the destination folder and image file number, then select **[OK]**.
  - To convert another image, repeat steps 2 and 3.

#### Note

- Some scenes may look different after conversion (if original and converted images are compared).
- Conversion is not available for cropped images, or for frame-grab images from 4K or 8K movies.

# Slide Show

---

You can play back the images on the card as an automatic slide show.

---

## 1. Specify the images to be played back.

- To play back all the images on the card, go to step 2.
- If you want to specify the images to be played back in the slide show, filter the images with [▶]: **Set image search conditions** (🔍).

## 2. Select [▶]: **Slide show**.

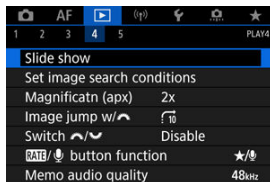

### 3. Set the playback as desired.

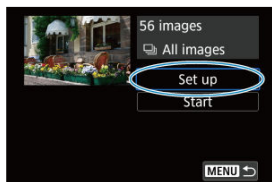

- Select [**Set up**].
- Set the [**Display time**] and [**Repeat**] (repeated playback) settings for the still photos.
- After completing the settings, press the < **MENU** > button.

#### Display time

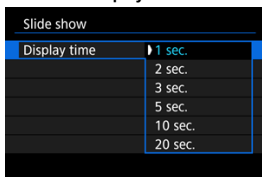

#### Repeat

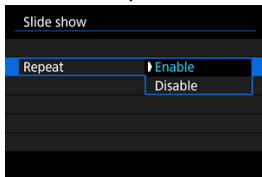

#### 4. Start the slide show.

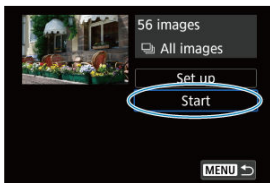





- Select [**Start**].
- After [**Loading image...**] is displayed, the slide show will start.

#### 5. Exit the slide show.

- To exit the slide show and return to the setting screen, press the < **MENU** > button.

#### Note

- To pause the slide show, press < **SET** >. During pause,  will be displayed in the upper left of the screen. Press < **SET** > again to resume the slide show.
- During the automatic playback of still photos, you can press the < **INFO** > button to switch the display format ().
- During movie playback, you can adjust the sound volume by turning the <  > dial.
- During auto playback or when playback is paused, you can turn the <  > dial to view another image.
- During auto playback, auto power off will not take effect.
- The display time may differ depending on the image.

# Setting Image Search Conditions

---

## [Clearing the Search Conditions](#)

You can filter image display according to your search conditions. After setting the image search conditions, you can play back and display only the found images. You can also protect, rate, play a slide show, erase, and apply other operations to filtered images.

---

1. Select [: Set image search conditions].

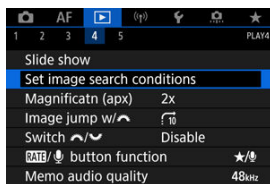





## 2. Set the search conditions.



(1)

- Turn the <  > dial to select an option.
- Turn the <  > dial to set the option.
- A checkmark [✓] (1) is appended to the left of the option. (Specified as the search condition.)
- If you select the option and press the < INFO > button, the checkmark [✓] will be removed (which cancels the search condition).

Option	Description
★ Rating	Displays images with the selected (rating) condition.
📅 Date	Displays images taken on the selected shooting date.
📁 Folder	Displays images in the selected folder.
🔒 Protect	Displays images with the selected (protect) condition.
📄 Type of file (1)	Displays images of the selected file type.
📄 Type of file (2)	

### 3. Apply the search conditions.

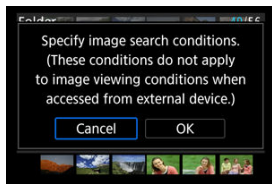

- Press < **SET** > and read the message displayed.
- Select [**OK**].  
The search condition is applied.

### 4. Display the found images.



(2)

- Press the < **▶** > button.  
Only the images that match the set conditions (filtered) will be played back.  
When the images are filtered for display, the screen will have an outer yellow frame (2).

#### **!** Caution

- If no images match the search conditions, < **SET** > cannot be pressed in step 3.



#### Note

- Search conditions may be cleared after operations involving camera power or card changes and editing, adding, or erasing images.
- Auto power off time may be extended while the [▶]: **Set image search conditions**] screen is displayed.



## Clearing the Search Conditions

---

Access the screen in step 2, then press the <  > button to clear all the search conditions.

## Browsing Images with the Main Dial

In single-image display, you can turn the <  > dial to jump through the images forward or backward according to the jump method set.

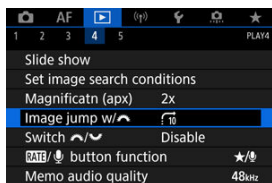

1. Select [: Image jump w/].

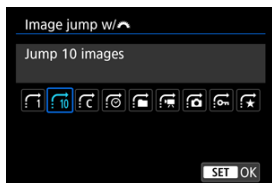

2. Select the jump method.



### Note

- With [**Jump images by the specified number**], you can turn the <  > dial to select the number of images to jump by.
- With [**Display by image rating**], turn the <  > dial to select the rating (). Selecting ★ will show all rated images as you browse.

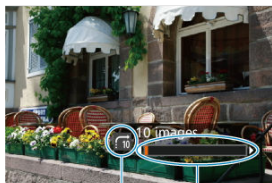

### 3. Browse by jumping.



(1)



(2)

- (1) Jump method
- (2) Playback position

- Press the <  > button.
- In single-image display, turn the <  > dial.  
You can browse by the jump method set.

## Switching the Main Dial and Quick Control Dial 2



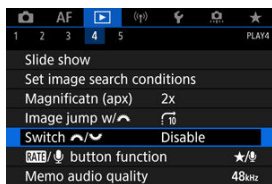

You can switch the functions assigned to these dials, as used on the image playback screen.

1. Select []: Switch /.

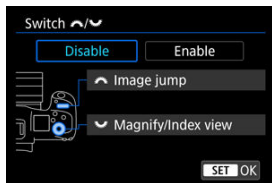

2. Select an option.



- [Disable]
  -  Image jump
  -  Magnify/Index view
- [Enable]
  -  Magnify/Index view
  -  Image jump

### Note

- Corresponding icons in menus and on screens such as the Quick Control and Magnify/Reduce screen are changed accordingly.

## Rate/Voice Memo Button Function

---

You can assign image rating/protection/erasure or voice memo recording/playback to the < **RATE** > button.

---

1. Select [▶]: **RATE**/🎤 button function].

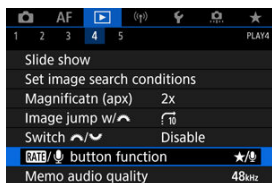

## 2. Select an option.

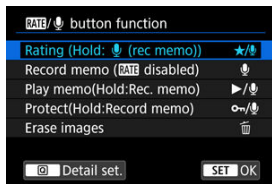

- ★/[voice icon]: **Rating (Hold: [voice icon] (rec memo))**  
Assigns rating to the < **RATE** > button. (Default setting.)  
You can press the < [Q] > button to select the rating to use.  
During playback, you can rate images or clear ratings by pressing the < **RATE** > button. You can also hold it down for 2 sec. to start recording a voice memo.
- [voice icon]: **Record memo (RATE disabled)**  
Assigns voice memo recording to the < **RATE** > button.  
During image playback, you can start recording a voice memo by pressing the < **RATE** > button.
- ▶/[voice icon]: **Play memo(Hold:Rec. memo)**  
Assigns voice memo playback to the < **RATE** > button.  
During image playback, you can play a voice memo by pressing the < **RATE** > button. You can also hold it down for 2 sec. to start recording a voice memo.
- [lock icon]/[voice icon]: **Protect(Hold:Record memo)**  
Assigns protection to the < **RATE** > button.  
During playback, you can protect images or clear protection by pressing the < **RATE** > button. You can also hold it down for 2 sec. to start recording a voice memo.
- [trash icon]: **Erase images**  
Assigns erasure to the < **RATE** > button.  
During playback, you can erase images by pressing the < **RATE** > button.



# Customizing Playback Information Display

## [Histogram](#)



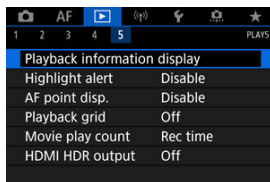

You can specify screens and accompanying information displayed during image playback.

1. Select []: Playback information display].



2. Add a checkmark [✓] next to the number of screens to display.



- Select numbers with the  dial.
- Press  to add a checkmark [✓].
- Repeat these steps to add a checkmark [✓] to the number of each screen to display, then select [OK].
- Your selected information can be accessed by pressing the  button during playback, or by using  when shooting information is displayed.

## Histogram

---

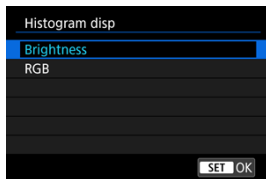

The histograms show signal levels across the tonal range. Brightness display (for checking the general exposure level and overall gradation) and RGB display (for checking saturation and gradation of red, green, and blue) are available. You can switch the histogram displayed by pressing the <INFO> button when [INFO] is displayed in the lower left of the [▶]: **Playback information display** screen.

- **[Brightness] display**

This histogram is a graph showing the distribution of the image's brightness level, with the horizontal axis indicating the brightness level (darker on the left and brighter on the right) and the vertical axis indicating the pixel count at each brightness level. The more pixels there are toward the left, the darker the image, and the more pixels there are toward the right, the brighter the image. If there are too many pixels on the left, detail in shadows will be lost, and if there are too many pixels on the right, detail in highlights will be lost. The gradation in-between will be reproduced. By checking the image and its brightness histogram, you can see the exposure level inclination and the overall gradation.

### Sample histograms



Dark image



Normal brightness



Bright image

- **[RGB] display**

This histogram is a graph showing the distribution of each primary color's brightness level in the image (RGB or red, green, and blue), with the horizontal axis indicating the color's brightness level (darker on the left and brighter on the right) and the vertical axis indicating the pixel count at each color brightness level. The more pixels there are toward the left, the darker and less prominent the color, and the more pixels there are toward the right, the brighter and denser the color. If there are too many pixels on the left, the corresponding color information will be lacking, and if there are too many pixels on the right, the color will be too saturated, without gradation. By checking the image's RGB histogram, you can see the color's saturation and gradation conditions, as well as the white balance bias.

# Displaying the Highlight Alert

---

You can specify blinking display of overexposed highlights on the playback screen. To obtain more detailed gradation in the blinking areas where you want the gradation to be faithfully reproduced, set the exposure compensation to a negative amount and shoot again for a better result.

---

1. Select [: Highlight alert].

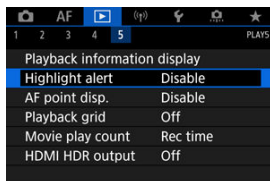

2. Select [Enable].

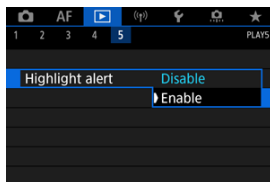

# AF Point Display

---

You can display the AF points that were used to focus, which will be outlined in red on the playback screen. If automatic AF point selection is set, multiple AF points may be displayed.

1. Select [: AF point disp.].

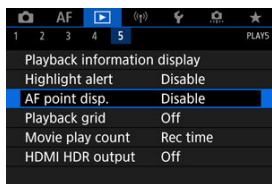

2. Select [Enable].

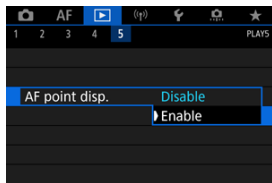

# Playback Grid

---

You can display a grid over still photos shown in single-image display on the playback screen. This function is convenient for checking the image's vertical or horizontal tilt as well as composition.

---

1. Select [: Playback grid].

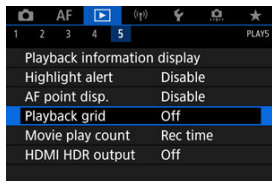

2. Select an option.

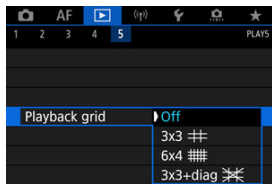

# Movie Play Count

---

You can select how time is displayed on the movie playback screen.

---

1. Select [▶]: Movie play count].

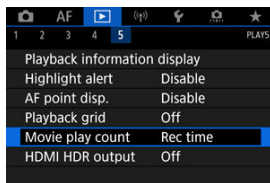



## 2. Select an option.

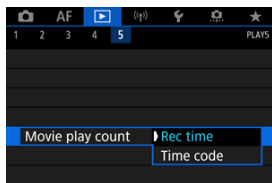

- **Rec time**

Displays the recording or playback time during movie playback.



- **Time code**

Displays the time code during movie playback.



### Note

- Time codes are always recorded to movie files (except for High Frame Rate movies set to **[Free run]**), regardless of the **[Movie rec count]** setting.
- The **[Movie play count]** setting in **[Camera icon]: Time code** is linked to the **[Play button icon]: Movie play count**, so that these settings always match.
- The “frame” count is not displayed during movie recording or playback.

# HDMI HDR Output

You can view RAW or HEIF images in HDR by connecting the camera to an HDR TV.

1. Select [▶]: HDMI HDR output].

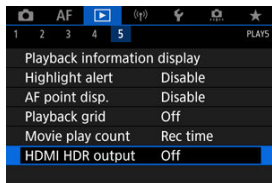

2. Select [On].

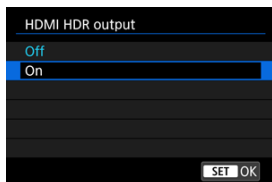

## Note

- Make sure the HDR TV is set up for HDR input. For details on how to switch inputs on the TV, refer to the TV manual.
- Depending on the TV used, images may not look as expected.
- On HDR TVs, some information may not be displayed.
- Quick Control RAW processing of displayed images is recommended if you will process RAW images while viewing HDMI HDR output.

## Wireless Features

---

This chapter describes how to connect the camera to a smartphone, computer, FTP server, or Web service wirelessly via Bluetooth or Wi-Fi and send images, as well as how to use a wireless remote control or GPS device.

### Caution

#### Important

- Note that Canon cannot be held liable for any loss or damage caused by erroneous wireless communication settings when using the camera. In addition, Canon cannot be held liable for any other loss or damage caused by use of the camera. When using wireless communication functions, establish appropriate security at your own risk and discretion. Canon cannot be held liable for any loss or damage caused by unauthorized access or other security breaches.

- [Tab Menus: Wireless Features](#)
- [Wi-Fi/Bluetooth Connection](#)
- [Connecting to a Smartphone](#)
- [Connecting to a Computer via Wi-Fi](#)
- [Sending Images to a Web Service](#)
- [Image Transfer to FTP Servers](#)
- [Wi-Fi Connection via Access Points](#)
- [Connecting to a Wireless Remote Control](#)
- [Reconnecting via Wi-Fi](#)
- [Registering Multiple Connection Settings](#)
- [Airplane Mode](#)
- [Wi-Fi Settings](#)
- [Bluetooth Settings](#)
- [Nickname](#)
- [GPS Device Settings](#)
- [Changing or Deleting Connection Settings](#)
- [Resetting Communication Settings](#)
- [View Info Screen](#)
- [Virtual Keyboard Operations](#)
- [Responding to Error Messages](#)
- [Wireless Communication Function Precautions](#)
- [Security](#)
- [Checking Network Settings](#)
- [Wireless Communication Status](#)

## Tab Menus: Wireless Features

---

### ● Wireless features 1

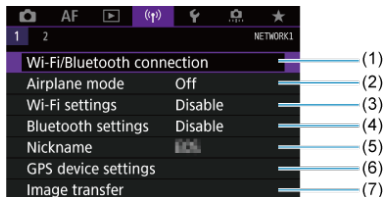

- (1) [Wi-Fi/Bluetooth connection](#)
- (2) [Airplane mode](#)
- (3) [Wi-Fi settings](#)
- (4) [Bluetooth settings](#)
- (5) [Nickname](#)
- (6) [GPS device settings](#)
- (7) [Image transfer](#)

### ● Wireless features 2

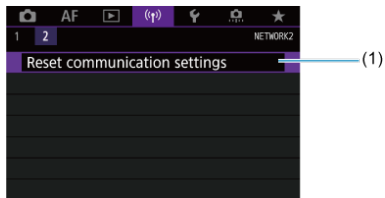

- (1) [Reset communication settings](#)

 **Caution**

- Wireless communication is not available while the camera is connected via an interface cable to a computer or other device.
- Other devices, such as computers, cannot be used with the camera by connecting them with an interface cable while the camera is connected to devices via Wi-Fi.
- The camera cannot be connected via Wi-Fi if there is no card in it (except for [📄], [📱], or [📶]).
- The Wi-Fi connection will be terminated if you set the camera's power to <OFF>, or open the card slot cover or battery compartment cover (but FTP transfer connections will continue even with the power set to <OFF>).
- With a Wi-Fi connection established, the camera's auto power off does not function.

## Wi-Fi/Bluetooth Connection

---

1. Select []: **Wi-Fi/Bluetooth connection**].

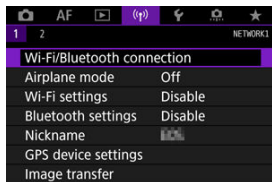

2. Select an option for the camera to connect to.

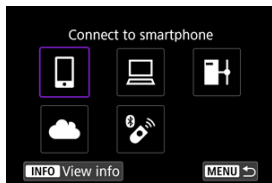

### **Connect to smartphone**

Control the camera remotely and browse images on the camera over a Wi-Fi connection by using the dedicated Camera Connect app on smartphones or tablets (collectively referred to as “smartphones” in this manual). After pairing the camera with a smartphone supporting Bluetooth low energy technology (hereafter, “Bluetooth”), you only need to use the smartphone to connect via Wi-Fi.

### **Remote control (EOS Utility)**

Connect the camera to a computer via Wi-Fi and operate the camera remotely using EOS Utility (EOS software). Images on the camera can also be sent to the computer.

### **Transfer images to FTP server**

Your images can be transferred to an FTP server on the network the camera is connected to.

## **Upload to Web service**

Images can be sent automatically to the image.canon cloud service for Canon customers after you complete member registration (free of charge). Original files of images sent to image.canon are retained for 30 days, without storage limitations, and can be downloaded to computers or transferred to other Web services.

## **Connect to Wireless Remote**





This camera can also be connected to Wireless Remote Control BR-E1 (sold separately) via Bluetooth for remote control shooting.

## Connecting to a Smartphone



---

- [!\[\]\(cd3e54d951a9fb854f48e4697cf550f9\_img.jpg\) Turning on Bluetooth and Wi-Fi on a Smartphone](#)
- [!\[\]\(cc729e263f29c0a76fbdc4cfe67fceb0\_img.jpg\) Installing Camera Connect on a Smartphone](#)
- [!\[\]\(90d36d418f8f7ab67431ba2525e00a5e\_img.jpg\) Connecting to a Bluetooth-Compatible Smartphone via Wi-Fi](#)
- [!\[\]\(f70e40faeec369ff477dbaef549ee05b\_img.jpg\) Camera Connect Functions](#)
- [!\[\]\(ca68c0c79a5dc0026aa1d011fda2b676\_img.jpg\) Maintaining a Wi-Fi Connection When the Camera Is Off](#)
- [!\[\]\(caba7331972dceb944f99aa56fee2f81\_img.jpg\) Canceling the Pairing](#)
- [!\[\]\(c8a030d79816aa5f757cd6099c7d9a8e\_img.jpg\) Wi-Fi Connection without Using Bluetooth](#)
- [!\[\]\(4a09161e9d0b0aaec8ec1149656d0974\_img.jpg\) Automatic Image Transfer as You Shoot](#)
- [!\[\]\(9223deec401f24808aa5e7273d7c177a\_img.jpg\) Sending Images to a Smartphone from the Camera](#)
- [!\[\]\(30209071fbd04bbf3436f8eccf8c6fd7\_img.jpg\) Terminating Wi-Fi Connections](#)
- [!\[\]\(5d5ad7b451faf49eae298b1de6b23ef7\_img.jpg\) Settings to Make Images Viewable from Smartphones](#)

You can do the following after pairing the camera with a Bluetooth-compatible smartphone.

- Establish a Wi-Fi connection using only the smartphone ()
- Establish a Wi-Fi connection with the camera even when it is off ()
- Geotag images with GPS information acquired by the smartphone ()
- Control the camera remotely from a smartphone ()

You can also do the following after connecting the camera to a smartphone via Wi-Fi.

- Browse and save images on the camera from a smartphone ()
  - Control the camera remotely from a smartphone ()
  - Send images to a smartphone from the camera ()
-



## Turning on Bluetooth and Wi-Fi on a Smartphone

---

Turn on Bluetooth and Wi-Fi from the smartphone settings screen. Note that pairing with the camera is not possible from the smartphone's Bluetooth settings screen.



### Note

- To establish a Wi-Fi connection via an access point, see [Wi-Fi Connection via Access Points](#).

## Installing Camera Connect on a Smartphone

---

The dedicated app Camera Connect (free of charge) must be installed on the smartphone on which Android or iOS is installed.

- Use the latest version of the smartphone OS.
- Camera Connect can be installed from Google Play or App Store. Google Play or App Store can also be accessed using the QR codes that appear when the camera is paired or connected via Wi-Fi to a smartphone.



### Note

- For the operating system versions supported by Camera Connect, refer to the download site of Camera Connect.
- Sample screens and other details in this guide may not match the actual user interface elements after camera firmware updates or updates to Camera Connect, Android, or iOS.

## Connecting to a Bluetooth-Compatible Smartphone via Wi-Fi

### Steps on the camera (1)

1. Select [(Ⓜ): Wi-Fi settings].

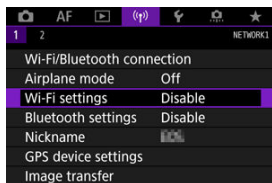

2. Select [Enable].

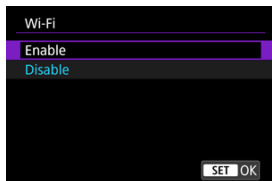

3. Select [(Ⓜ): Bluetooth settings].

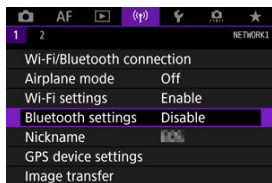

4. Select [Enable].

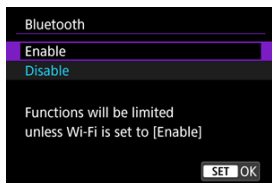

5. Select [Wi-Fi/Bluetooth connection].

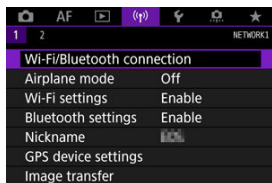

6. Select [Connect to smartphone].

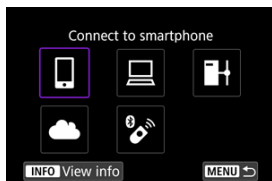

7. Select [Add a device to connect to].

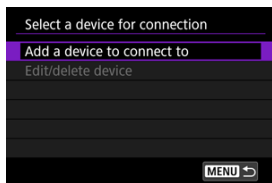

8. Select an option.

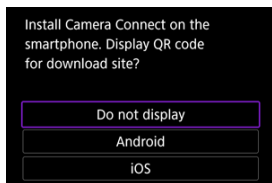

- If Camera Connect is already installed, select [**Do not display**].
- If Camera Connect is not installed, select [**Android**] or [**iOS**], scan the displayed QR code with the smartphone to access Google Play or App Store and install Camera Connect.

## 9. Select [Pair via Bluetooth].

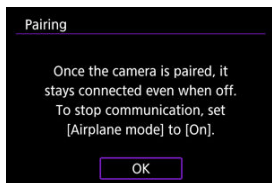

- Press < > to start pairing.



- To pair with a different smartphone after pairing with one initially, select [OK] on the screen shown above.

## Steps on the smartphone (1)

### 10. Start Camera Connect.



### 11. Tap the camera for pairing.

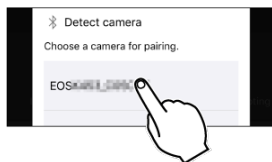

- In Android, go to [Steps on the camera \(2\)](#).

### 12. Tap [Pair] (iOS only).

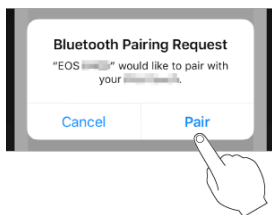

## Steps on the camera (2)

### 13. Select [OK].

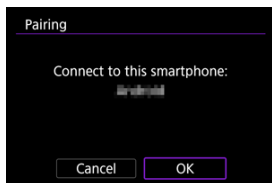

### 14. Press the <SET> button.

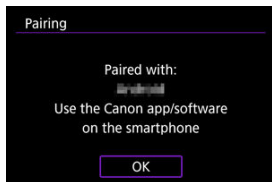

- Pairing is now complete, and the camera is connected to the smartphone via Bluetooth.

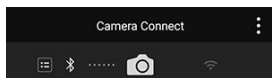

- A Bluetooth icon appears on the main Camera Connect screen.



### Caution

- The camera cannot be connected to two or more devices at the same time via Bluetooth. To switch to a different smartphone for the Bluetooth connection, see [Changing or Deleting Connection Settings](#).
- Bluetooth connection consumes battery power even after the camera's auto power off is activated. Therefore, the battery level may be low when you use the camera.

### **Troubleshooting pairing**

- Keeping pairing records for previously paired cameras on your smartphone will prevent it from pairing with this camera. Before you try pairing again, remove pairing records for previously paired cameras from your smartphone's Bluetooth settings screen.

### Note

- With a Bluetooth connection established, you can operate the camera to send images to the smartphone ()

## Steps on the smartphone (2)

### 15. Tap a Camera Connect function.

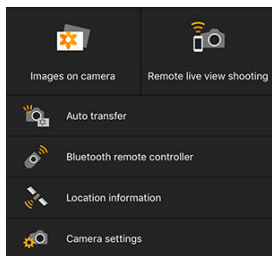

- In iOS, tap **[Join]** when a message is displayed to confirm camera connection.
- For the Camera Connect functions, see [Camera Connect Functions](#).
- When a Wi-Fi connection is established, the screen for the selected function will appear.

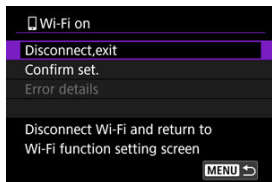

- **[Wi-Fi on]** is displayed on the camera screen.

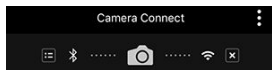

- The Bluetooth and Wi-Fi icons are lit on the main Camera Connect screen.

#### The Wi-Fi connection to a Bluetooth-compatible smartphone is now complete.

- For how to terminate the Wi-Fi connection, see [Terminating Wi-Fi Connections](#).
- Terminating the Wi-Fi connection will switch the camera to the Bluetooth connection.
- To reconnect via Wi-Fi, start Camera Connect and tap the function you will use.

## Wi-Fi on] screen

### **Disconnect,exit**

- Terminates the Wi-Fi connection.

### **Confirm set.**

- You can check the settings.

### **Error details**

- When a Wi-Fi connection error occurs, you can check the details of the error.

## Camera Connect Functions

---

### Images on camera

- Images can be browsed, deleted, or rated.
- Images can be saved on a smartphone.

### Remote live view shooting

- Enables remote shooting as you view a live image on the smartphone.

### Auto transfer

- Enables camera and app setting adjustment for automatic transfer of your shots (📷).

### Bluetooth remote controller

- Enables remote control of the camera from a smartphone paired via Bluetooth. (Not available when connected via Wi-Fi.)
- Auto power off is disabled while you are using the Bluetooth remote controller feature.

### Location information

- Not supported on this camera.

### Camera settings

- Camera settings can be changed.

## Maintaining a Wi-Fi Connection When the Camera Is Off

Even when the camera power switch is set to <OFF>, as long as it is paired to a smartphone via Bluetooth, you can use the smartphone to connect via Wi-Fi and browse images on the camera or perform other operations.

If you prefer not to connect via Wi-Fi to the camera when it is off, either set [Airplane mode] to [On] (📵) or set [Bluetooth settings] to [Disable].

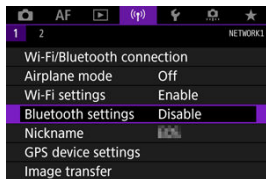

### ⚠ Caution

- This function can no longer be used if the wireless settings are reset or the smartphone connection information is erased.

## Canceling the Pairing

Cancel pairing with a smartphone as follows.

1. Select [(P): Wi-Fi/Bluetooth connection].

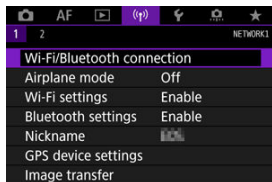

2. Select [☎Connect to smartphone].

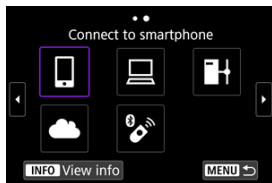

- If the history (☎) is displayed, switch screens with the < ⌂ > < ☰ > dial or < \* >.

3. Select [Edit/delete device].

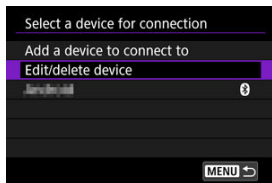

4. Select the smartphone to cancel pairing with.

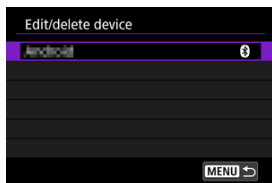

- Smartphones currently paired with the camera are labeled [0].

5. Select [Delete connection information].

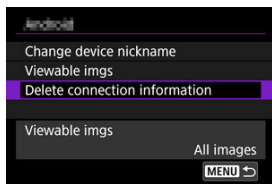

6. Select [OK].

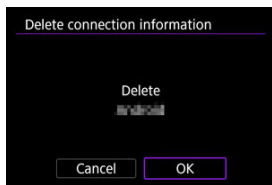

7. Clear the camera information on the smartphone.

- In the smartphone's Bluetooth setting menu, clear the camera information registered on the smartphone.

## Wi-Fi Connection without Using Bluetooth

### Steps on the camera (1)

1. Set Wi-Fi settings to [Enable].

- See steps 1–2 in [Connecting to a Bluetooth-Compatible Smartphone via Wi-Fi](#).

2. Select [(Wi-Fi/Bluetooth connection)].

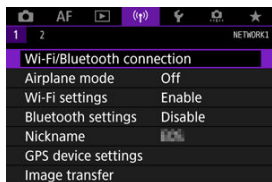

3. Select [☑ Connect to smartphone].

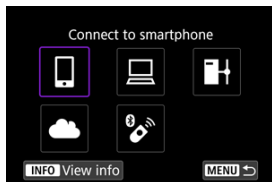

- If the history (☑) is displayed, switch screens with the < ⦿ > < ☺ > dial or < ✨ >.



4. Select [Add a device to connect to].



5. Select an option.

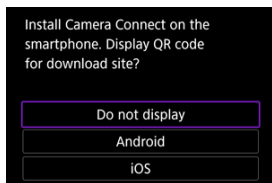

- If Camera Connect is already installed, select [Do not display].

6. Select [Connect via Wi-Fi].



## 7. Check the SSID (network name) and password.

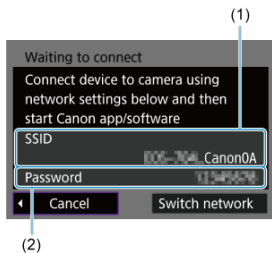

- Check the SSID (1) and Password (2) displayed on the camera screen.

### Note

- By selecting [**Switch network**] in step 7, you can establish a Wi-Fi connection via an access point (📶).

## Steps on the smartphone

### 8. Operate the smartphone to establish a Wi-Fi connection.

Smartphone's screen (sample)

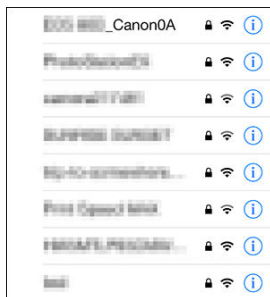

- Activate the smartphone's Wi-Fi function, then tap the SSID (network name) checked in step 7 in [Steps on the camera \(1\)](#).
- For the password, enter the password checked in step 7 in [Steps on the camera \(1\)](#).

### 9. Start Camera Connect and tap the camera to connect to via Wi-Fi.

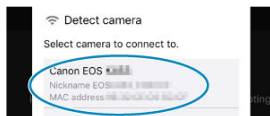

## Steps on the camera (2)

### 10. Select [OK].

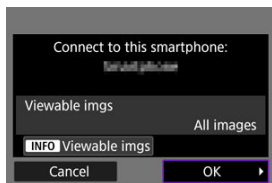

- To specify viewable images, press the <INFO > button. Configure as described in [Settings to Make Images Viewable from Smartphones](#), starting in step 5.

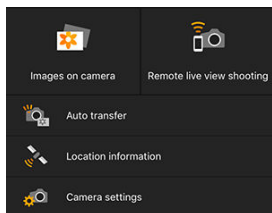

- The main window of Camera Connect will be displayed on the smartphone.

### The Wi-Fi connection to a smartphone is now complete.

- Operate the camera using Camera Connect (📷).
- For how to terminate the Wi-Fi connection, see [Terminating Wi-Fi Connections](#).
- To reconnect via Wi-Fi, see [Reconnecting via Wi-Fi](#).

#### Note

- When connected via Wi-Fi, you can send images to a smartphone from the Quick Control screen during playback (📷).

## Automatic Image Transfer as You Shoot

Your shots can be automatically sent to a smartphone. Before following these steps, make sure the camera and smartphone are connected via Wi-Fi.

1. Select [(Wi-Fi): Wi-Fi settings].

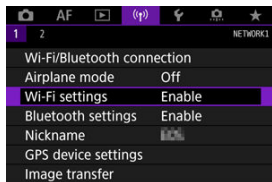

2. Select [Send to smartphone after shot].

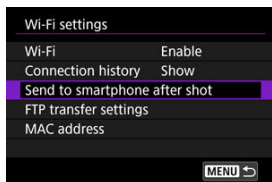

3. Set [Auto send] to [Enable].

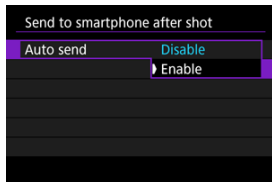

4. Set [Size to send].

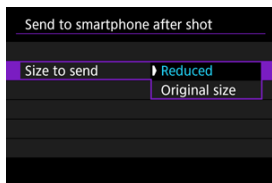

5. Take the picture.

## Sending Images to a Smartphone from the Camera

You can use the camera to send images to a smartphone paired via Bluetooth (Android devices only) or connected via Wi-Fi.

### 1. Switch to playback.

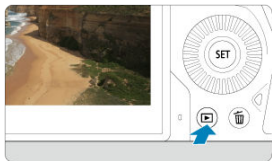

### 2. Press the < Q > button.

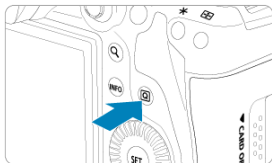

### 3. Select [☎ Send images to smartphone].

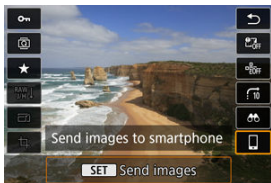



- If you perform this step while connected via Bluetooth, a message is displayed, and the connection switches to a Wi-Fi connection.

### 4. Select sending options and send the images.

## (1) Sending images individually

### 1. Select an image to send.



- Use the  dial to select an image to send, then press  >.
- You can turn the  dial counterclockwise to select the image using the index display.

### 2. Select [Send img shown].

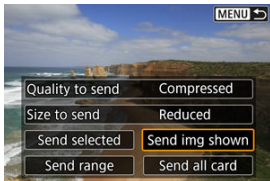

- In [**Size to send**], you can select the image sending size.
- When sending movies, you can select the image quality of movies to send in [**Quality to send**].



## (2) Sending multiple selected images

1. Press <SET>.



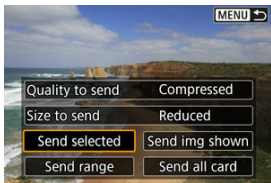

2. Select [Send selected].





### 3. Select images to send.

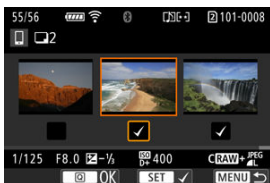

- Use the <  > dial to select images to send, then press <  >.



- You can turn the <  > dial counterclockwise to switch to select the images from 3-image display. To return to single-image display, turn the <  > dial clockwise.
- After selecting the images to send, press the <  > button.

#### 4. Select [Size to send].

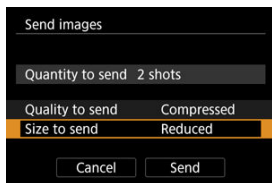

- On the displayed screen, select an image size.

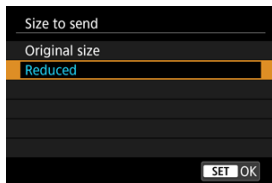

- When sending movies, select the image quality in [Quality to send].

#### 5. Select [Send].

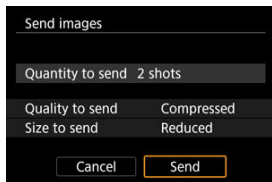

### (3) Sending a specified range of images

1. Press <  >.



2. Select [Send range].

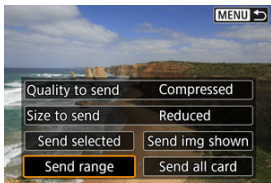

3. Specify the range of images.



- Select the first image (start point).
- Select the last image (end point).
- To cancel the selection, repeat this step.
- To change the number of images in index display, turn the <  > dial.

#### 4. Confirm the range.

- Press the < **Q** > button.

#### 5. Select [Size to send].

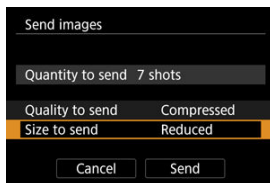

- On the displayed screen, select an image size.

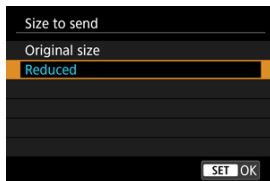

- When sending movies, select the image quality in [Quality to send].

#### 6. Select [Send].

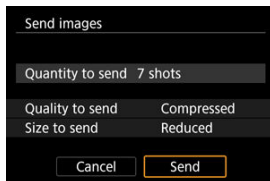

#### (4) Sending all images on the card

1. Press <SET>.



2. Select [Send all card].

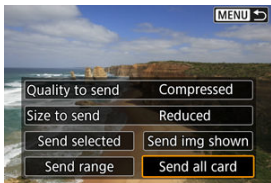

### 3. Select [Size to send].

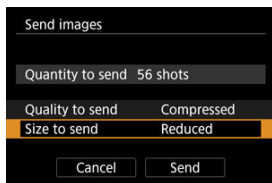

- On the displayed screen, select an image size.

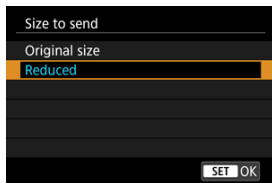

- When sending movies, select the image quality in [Quality to send].

### 4. Select [Send].

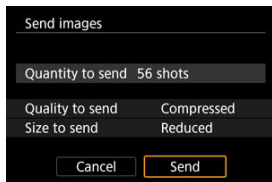

## (5) Sending images that match the search conditions

Send all the images that match the search conditions set in [Set image search conditions] at once. For details on [Set image search conditions], see [Setting Image Search Conditions](#).

1. Press < **SET** >.



2. Select [Send all found].

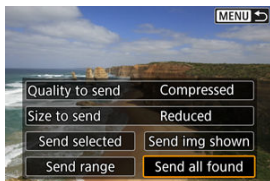



### 3. Select [Size to send].

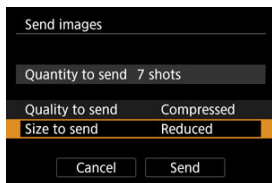

- On the displayed screen, select an image size.

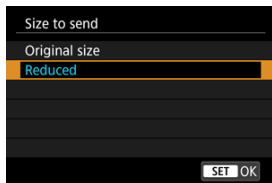

- When sending movies, select the image quality in [Quality to send].

### 4. Select [Send].

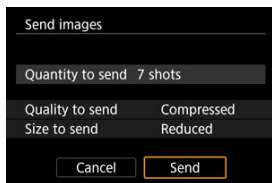

## Ending image transfer

### Sending images from the camera when paired via Bluetooth (Android devices only)



- Press the < **MENU** > button on the image transfer screen.

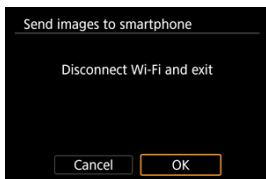

- Select [**OK**] to end image transfer and the Wi-Fi connection.

### Sending images from the camera over a Wi-Fi connection

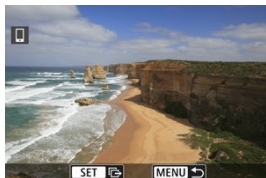

- Press the < **MENU** > button on the image transfer screen.
- To terminate the Wi-Fi connection, see [Terminating Wi-Fi Connections](#).

#### Caution

- During the image transfer operation, a picture cannot be taken even if the camera's shutter button is pressed.

 **Note**

- You can cancel the image transfer by selecting **[Cancel]** during the transfer.
- You can select up to 999 files at a time.
- With a Wi-Fi connection established, disabling the smartphone's power saving function is recommended.
- Selecting the reduced size for still photos applies to all still photos sent at that time. Note that **S2** size still photos are not reduced.
- Selecting compression for movies applies to all movies sent at that time. Note that **FHD 29.97P 1PB** and **FHD 25.00P 1PB** movies are not reduced.
- When you use a battery to power the camera, make sure it is fully charged.

## Terminating Wi-Fi Connections

---

Perform either of the following operations.

On the Camera Connect screen, tap [X].

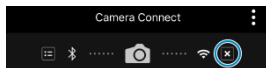

On the [Wi-Fi on] screen, select [Disconnect,exit].

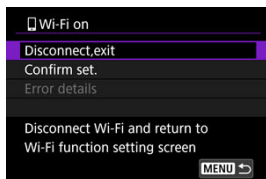

- If the [Wi-Fi on] screen is not displayed, select [(⌂): Wi-Fi/Bluetooth connection].
- Select [Disconnect,exit], then select [OK] on the confirmation screen.

## Settings to Make Images Viewable from Smartphones

Images can be specified after the Wi-Fi connection is terminated.

1. Select [(P): Wi-Fi/Bluetooth connection].

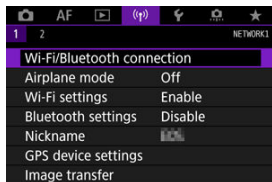

2. Select [☎Connect to smartphone].

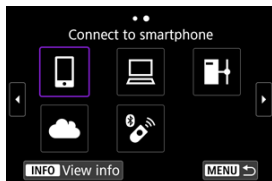

- If the history (☎) is displayed, switch screens with the < ⌂ > < ☰ > dial or < \* >.

3. Select [Edit/delete device].

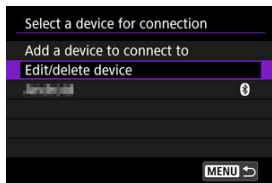

#### 4. Select a smartphone.

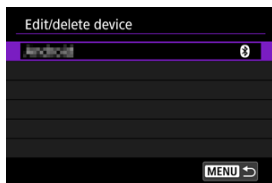

- Select the name of the smartphone on which you want to make the images viewable.

#### 5. Select [Viewable imgs].

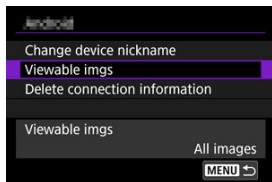

## 6. Select an option.

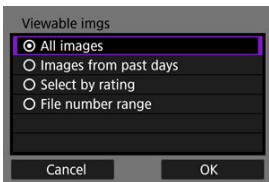

- Select **[OK]** to access the setting screen.

### **[All images]**

- All images stored on the card become viewable.

### **[Images from past days]**

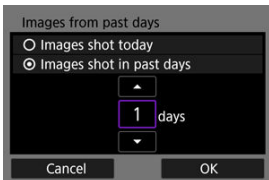

- Specify viewable images on the shooting-date basis. Images shot up to nine days ago can be specified.
- When **[Images shot in past days]** is selected, images shot up to the specified number of days before the current date become viewable. Use the **[▲]** **[▼]** keys to specify the number of days, then press **< [SET] >** to confirm the selection.
- Once you select **[OK]**, the viewable images are set.

### **! Caution**

- If **[Viewable imgs]** is set to any setting other than **[All images]**, remote shooting is not possible.

### [Select by rating]

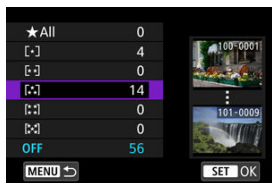

- Specify viewable images depending on whether a rating is appended (or not appended) or by the type of rating.
- Once you select the type of rating, the viewable images are set.

### [File number range] (Select range)

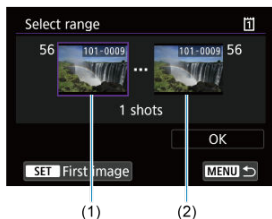

- Select the first and last images from images arranged by the file number to specify the viewable images.
  1. Press  $\langle \text{SET} \rangle$  to display the image selection screen. To select images, use the  $\langle \text{DIAL} \rangle$  dial or other controls.  
You can turn the  $\langle \text{DIAL} \rangle$  dial counterclockwise to select the image using the index display.
  2. Select an image as the starting point (1).
  3. Use the  $\langle \text{DIAL} \rangle$  dial to select an image as the ending point (2).
  4. Select [OK].



 **Caution**

- If the Wi-Fi connection is terminated while recording a movie with remote shooting, the following will occur.
  - Any movie recording in progress in movie recording mode will continue.
  - Any movie recording in progress in still photo shooting mode will end.
- With a Wi-Fi connection to a smartphone established, certain functions are unavailable.
- In remote shooting, the AF speed may become slower.
- Depending on the communication status, image display or shutter release timing may be delayed.
- When saving images to a smartphone, you cannot take a picture even if you press the camera's shutter button. Also, the camera screen may turn off.

 **Note**

- With a Wi-Fi connection established, disabling the smartphone's power saving function is recommended.

## Connecting to a Computer via Wi-Fi

---

[✔ Operating the Camera Using EOS Utility](#)

[✔ Direct Transfer](#)

[✔ Creating and Registering Captions](#)

This section describes how to connect the camera to a computer via Wi-Fi and perform camera operations using EOS Utility (EOS software). Install the latest version of EOS Utility on the computer before setting up a Wi-Fi connection.

For computer operating instructions, refer to the computer user manual.

---

### Operating the Camera Using EOS Utility

---

Using EOS Utility, you can import images from the camera, control the camera, and perform other operations.

#### Steps on the camera (1)

##### 1. Set Wi-Fi settings to [Enable].



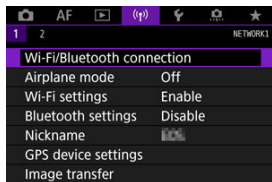

- See steps 1–2 in [Connecting to a Bluetooth-Compatible Smartphone via Wi-Fi](#).

##### 2. Select [(Wi-Fi): Wi-Fi/Bluetooth connection].

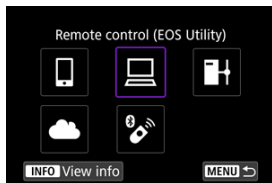

3. Select [ Remote control (EOS Utility)].



- If the history () is displayed, switch screens with the <  > <  > dial or <  >.

4. Select [**Add a device to connect to**].



5. Check the SSID (network name) and password.

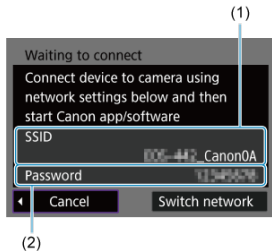

- Check the SSID (1) and password (2) displayed on the camera screen.

## Steps on the computer (1)

6. Select the SSID, then enter the password.

### Computer's screen (sample)

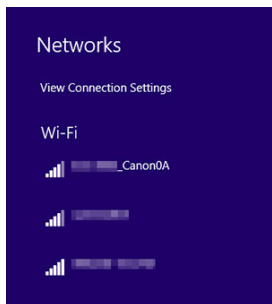

- On the computer's network setting screen, select the SSID checked in step 5 in [Steps on the camera \(1\)](#).
- For the password, enter the password checked in step 5 in [Steps on the camera \(1\)](#).

## Steps on the camera (2)

### 7. Select [OK].

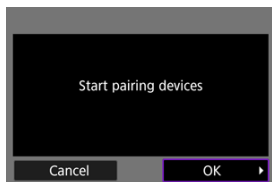

- The following message is displayed. "\*\*\*\*\*" represents the last six digits of the MAC address of the camera to be connected.

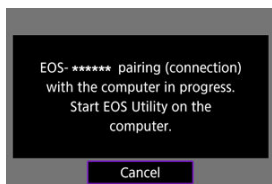

## Steps on the computer (2)

### 8. Start EOS Utility.

### 9. In EOS Utility, click [Pairing over Wi-Fi/LAN].

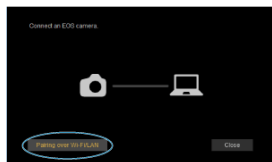

- If a firewall-related message is displayed, select [Yes].

## 10. Click [Connect].

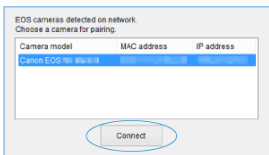

- Select the camera to connect to, then click **[Connect]**.

## Steps on the camera (3)

## 11. Establish a Wi-Fi connection.

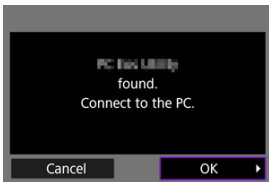

- Select **[OK]**.

## [Wi-Fi on] screen

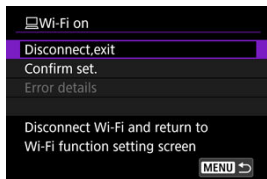

### **Disconnect,exit**

- Terminates the Wi-Fi connection.

### **Confirm set.**

- You can check the settings.

### **Error details**

- When a Wi-Fi connection error occurs, you can check the details of the error.

### **The Wi-Fi connection to a computer is now complete.**

- Operate the camera using EOS Utility on the computer.
- To reconnect via Wi-Fi, see [Reconnecting via Wi-Fi](#).

### **Caution**

- If the Wi-Fi connection is terminated while recording a movie with remote shooting, the following will occur.
  - Any movie recording in progress in movie recording mode will continue.
  - Any movie recording in progress in still photo shooting mode will end.
- You cannot use the camera to shoot in still photo shooting mode when it is set to movie recording mode in EOS Utility.
- With a Wi-Fi connection to EOS Utility established, certain functions are unavailable.
- In remote shooting, the AF speed may become slower.
- Depending on the communication status, image display or shutter release timing may be delayed.
- In Remote Live View shooting, the rate of image transmission is slower compared to a connection via an interface cable. Therefore, moving subjects cannot be displayed smoothly.

## Direct Transfer

With the camera connected to EOS Utility and the main EOS Utility window displayed, you can use the camera to transfer images to computer.

### Selecting images to transfer

1. Select [**(i)**: Image transfer].

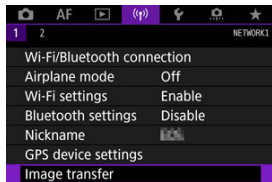

2. Select [**Image sel./transfer**].

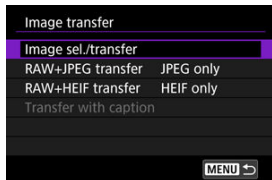

3. Select [**Direct transfer**].











#### 4. Select [Sel.Image].



#### 5. Select images to transfer.



- Use the  dial to select an image to transfer, then press .
- Use the  dial to add a checkmark [✓] in the upper left of the screen, then press .
- You can turn the  dial counterclockwise to switch to selecting images from 3-image display. To return to single-image display, turn the  dial clockwise.
- To select other images to transfer, repeat step 5.
- After image selection, press the .

#### 6. Select [Direct transfer].



7. Select [OK].



- The selected images are transferred to the computer.

## Selecting multiple images

Multiple images can be transferred at once after you choose a selection method.

### 1. Access the [Image sel./transfer] screen.

- Follow steps 1–3 in [Selecting Images to Transfer](#).

### 2. Select [Multiple].



### 3. Select a selection method to use.

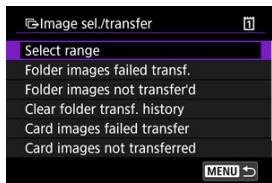

#### ● Select range



- Select **[Select range]**. Selecting the first and last images of the range marks all the images in the range with a checkmark [✓], and one copy of each image will be sent.
- To change the number of images in index display, turn the <  > dial.

● In a folder

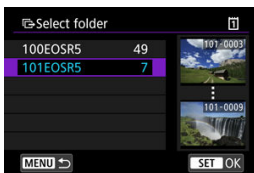

- Selecting [**Folder images failed transf.**] selects all images in the selected folder for which transfer failed.
- Selecting [**Folder images not transfer'd**] selects all unsent images in the selected folder.
- Selecting [**Clear folder transf. history**] clears the transfer history of images in the selected folder. After clearing the transfer history, you can select [**Folder images not transfer'd**] and transfer all images in the folder again.

● In a card



- Selecting [**Card images failed transfer**] selects all images in the selected card for which transfer failed.
- Selecting [**Card images not transferred**] selects all unsent images in the selected card.
- Selecting [**Clear card's transf. history**] clears the transfer history of images in the selected card. After clearing the transfer history, you can select [**Card images not transferred**] and transfer all images in the card again.

4. Select [**Direct transfer**].



5. Select [OK].



- The selected images are transferred to the computer.

## Transferring RAW+JPEG or RAW+HEIF images

For RAW+JPEG or RAW+HEIF images, you can specify which image to transfer.

1. Select [(P): Image transfer].

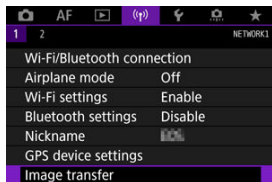

2. Select the type of images to transfer.

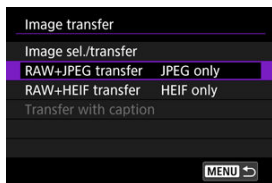

- **RAW+JPEG transfer**

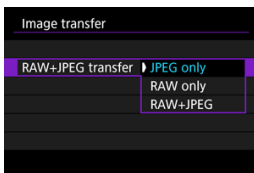

- Select [**RAW+JPEG transfer**], then select [**JPEG only**], [**RAW only**], or [**RAW+JPEG**].

- **RAW+HEIF transfer**

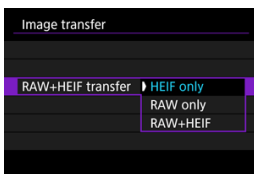

- Select [**RAW+HEIF transfer**], then select [**HEIF only**], [**RAW only**], or [**RAW+HEIF**].

 **Caution**

- Some menu items are not available during image transfer.

 **Note**

- This setting is linked to [**RAW+JPEG transfer**] and [**RAW+HEIF transfer**] settings on the [**Transfer type/size**] screen .

## Creating and Registering Captions

You can create captions and register them on the camera to use them as described in [Adding a Caption Before Transfer](#).

1. Start EOS Utility and select [Camera settings].

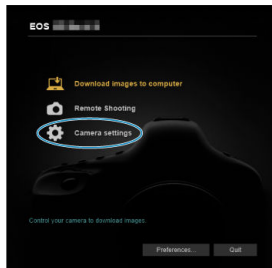

2. Select [WFT Captions].

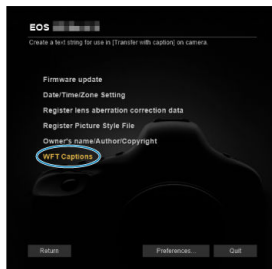

3. Enter the caption or captions.

Register text to use with  
[Transfer with caption] feature.

1	<input type="text" value="Canon"/>
2	<input type="text" value="1"/>
3	<input type="text" value="2"/>
4	<input type="text" value="3"/>

- Enter up to 31 characters (in ASCII format).
- To acquire caption data stored on the camera, select [Load settings].



#### 4. Set the captions on the camera.

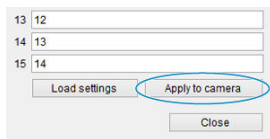

A screenshot of a camera settings dialog box. It features three input fields with the following values: 13, 14, and 15. Below the input fields are three buttons: 'Load settings', 'Apply to camera', and 'Close'. The 'Apply to camera' button is circled in blue.

13	12
14	13
15	14

Buttons: Load settings, Apply to camera, Close

- Select [**Apply to camera**] to set your new captions on the camera.

# Sending Images to a Web Service

---

This section describes how to send images to image.canon.

---

## Registering Image.Canon and Setting Up Auto Send

---

You can register image.canon on the camera and prepare to send your shots automatically.

- A computer or smartphone with a browser and internet connection is required.
- You will need to enter an email address used on your computer or smartphone.
- For instructions on how to use image.canon services and details on countries and regions where it is available, visit the image.canon site (<https://image.canon/>).
- Separate ISP connection and access point fees may apply.

### Steps on the camera (1)

#### 1. Set Wi-Fi settings to [Enable].

- See steps 1–2 in [Connecting to a Bluetooth-Compatible Smartphone via Wi-Fi](#).

#### 2. Select [(Wi-Fi): Wi-Fi/Bluetooth connection].

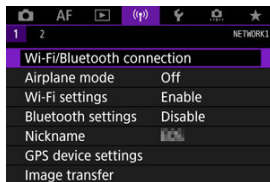

3. Select [ Upload to Web service].

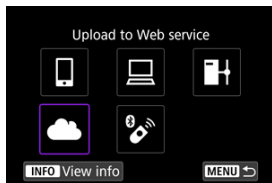

4. Select [**I Agree**].

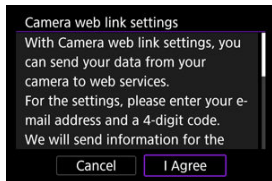

5. Establish a Wi-Fi connection.

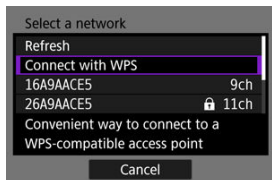

- Connect to an access point via Wi-Fi. Go to step 6 in [Wi-Fi Connection via Access Points](#).

## 6. Enter your email address.

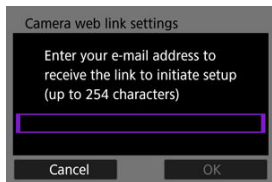

- Enter your email address, then select **[OK]**.

## 7. Enter a four-digit number.

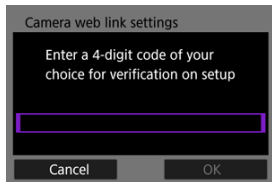

- Enter a four-digit number of your choice, then select **[OK]**.

## 8. Select [OK].

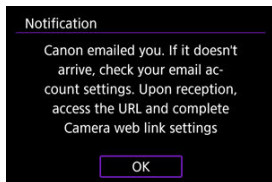

- The [🌩️] icon changes to [🌩️📧].

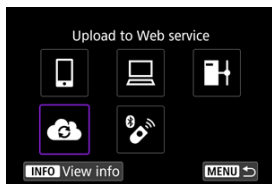

## Steps on the computer or smartphone

## 9. Set up camera web link.

- Access the page in the notification message.
- Follow the instructions to complete the settings on the camera web link settings page.

## Steps on the camera (2)

### 10. Select [OK].

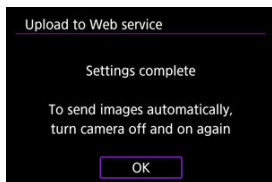

- The [📶] icon changes to [☁️].

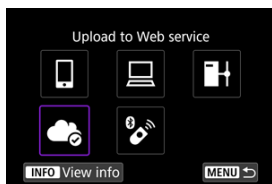

### 11. Select [Upload to Web service].

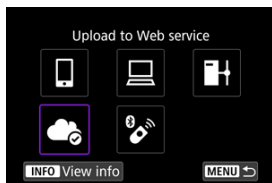

## 12. Select [Auto send].

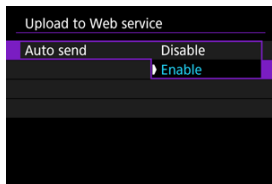

- Once **[Enable]** is set, images are automatically sent when you turn the camera on.

## 13. Select [Type to send].

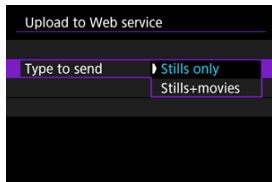

- Set to **[Stills only]** or **[Stills+movies]**.

## 14. Restart the camera.

- The images are now sent automatically.

- To switch networks, select **[Switch network]** and follow steps 5–8.
- To remove the connection, select **[Clear camera web link settings]** and then **[OK]**.

### Note

- All image files on cards are sent when **[Auto send]** is set to **[Enable]**.
- When **[Auto send]** is set to **[Enable]**, auto send starts after the camera starts up (or recovers from auto power off).
- Any images captured during auto sending are also sent.

 **Caution**

- Auto send does not start during interval timer shooting.
- Transfer stops in the following cases.
  - **[Airplane mode]** is set to **[On]**
  - Movie recording is started
  - A USB connection is started
  - Battery capacity is low
  - The camera's power switch is set to **< OFF >**



# Image Transfer to FTP Servers

---

- [✔ Preparation](#)
- [✔ Connecting to the Access Point](#)
- [✔ Configuring FTP Server Connection Settings](#)
- [✔ FTP Transfer Settings](#)
- [✔ Transferring Multiple Images at Once](#)
- [✔ Adding a Caption Before Transfer](#)
- [✔ Auto Retry If Transfer Fails](#)
- [✔ Viewing Transferred Images](#)

Your images can be transferred to an FTP server on the network the camera is connected to.

---

## Preparation

---

A computer running one of the following OSes is required. The computer must also be set up in advance to function as an FTP server.

- Windows 10 (ver. 1607 or later)
- Windows 8.1, Windows 8.1 Pro

For instructions on setting up the computer to function as an FTP server, refer to documentation for your computer.

Connect the computer to use as an FTP server to the access point in advance.

## Connecting to the Access Point

1. Set Wi-Fi settings to [Enable].
  - See steps 1–2 in [Connecting to a Bluetooth-Compatible Smartphone via Wi-Fi](#).
2. Select [(⌘): Wi-Fi/Bluetooth connection].

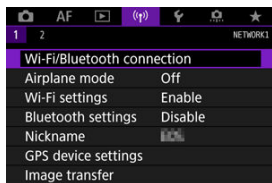

3. Select [📷+Transfer images to FTP server].

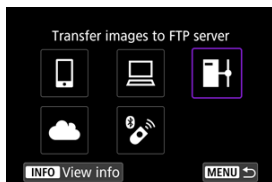

4. Select [Add a device to connect to].



## 5. Select [Setting method].

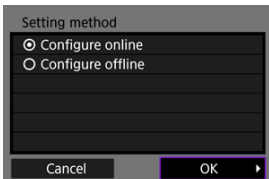

- Select an option and then **[OK]** to go to the next screen.
- Select **[Configure online]** to configure connection settings and then join the network.
- Select **[Configure offline]** to configure FTP server connection settings without connecting.

## 6. Select [Connect with WPS].

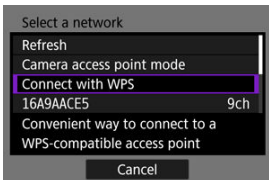

- Follow these steps to connect via WPS (PBC mode). To connect to access points in other ways, see [Wi-Fi Connection via Access Points](#).

## 7. Select [WPS (PBC mode)].

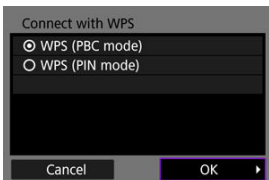

- Select **[OK]**.

8. Press the WPS button on the access point.

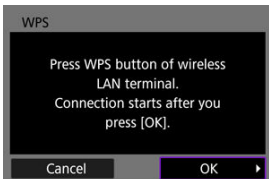

- For details on where the WPS button is and how long to press it, refer to the access point user manual.
- Select **[OK]** to initiate connection with the access point. The following screen is displayed once the camera is connected to the access point.

9. Select an IP address setting option.

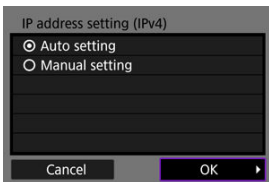

- Select **[OK]**.

10. Select an IPv6 option.

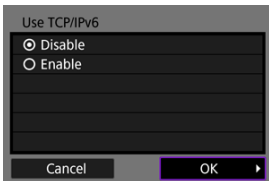

- Select **[OK]**.

## Configuring FTP Server Connection Settings

### 1. Select an FTP mode.

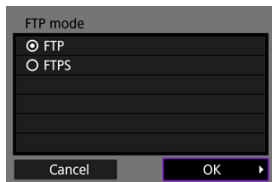

- For secure FTP transfer using a root certificate, select **[FTPS]**. For details on root certificate settings, see [Set Root Certif.](#)
- Select **[OK]** to go to the next screen.

### 2. Select **[Address setting]**.

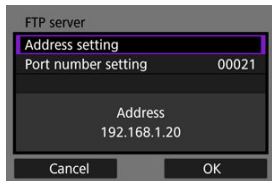

- Select **[OK]** to go to the next screen.
- The virtual keyboard is displayed if you have specified **[Auto setting]** for the IP address or **[Manual setting]** for the DNS address.
- A screen for numerical input is displayed if you have specified **[Disable]** for the DNS address.

### 3. Enter the FTP server IP address.



- Use the virtual keyboard (🖱️) to enter the IP address. If DNS is used, enter the domain name.
- To set the entered values and return to the screen for step 2, press the <MENU> button.

### 4. Configure the port number.

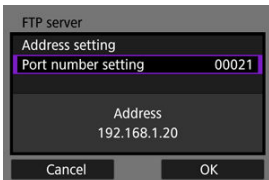

- Normally, set [**Port number setting**] to 00021.
- Select [**OK**] to go to the next screen.

### 5. Configure the passive mode setting.

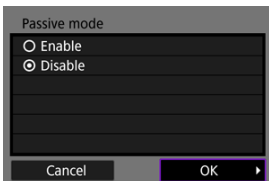

- Select [**OK**] to go to the next screen.
- If an Error 41 (**Cannot connect to FTP server**) is displayed in step 8, setting [**Passive mode**] to [**Enable**] may resolve it.

## 6. Configure proxy server settings.

The screenshot shows a dialog box titled "Proxy server". It contains the following fields and values:

Proxy server	Disable
Address setting	
Port number setting	10021
Address	0.0.0.0

At the bottom of the dialog box, there are two buttons: "Cancel" and "OK". The "OK" button is highlighted with a red border.

- Not displayed if you selected [FTPS] in step 1.
- Select [OK] to go to the next screen.

## 7. Configure the login method.

The screenshot shows a dialog box titled "Login method". It contains the following options and fields:

- Anonymous
- Login password

Below the radio buttons, there is a field for "Login name" with the value "anonymous" displayed below it.

At the bottom of the dialog box, there are two buttons: "Cancel" and "OK". The "OK" button is highlighted with a red border.

- Select [OK] to go to the next screen.

## 8. Specify a target folder.

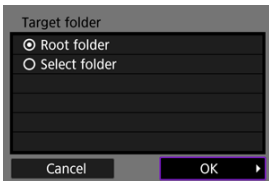

- Select [**Root folder**] to have images saved in the root folder, as specified in FTP server settings.
- Select [**Select folder**] to specify a target folder in the root folder. If the folder does not exist, it is created automatically.
- Select [**OK**] to go to the next screen.
- When the following message appears, select [**OK**] to trust the target server.

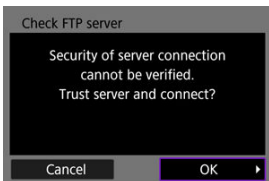

## 9. Select [OK].

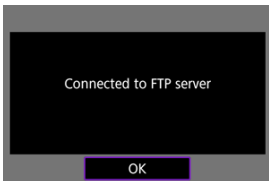

- Not displayed in offline configuration.

Connection settings for FTP transfer are now complete.



## FTP Transfer Settings

You can configure settings related to FTP transfer and power saving.

1. Select [(Wi-Fi): Wi-Fi settings].

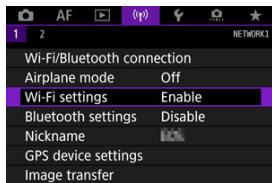

2. Select [FTP transfer settings].

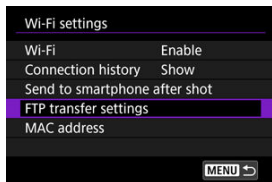

### 3. Select an option to configure.

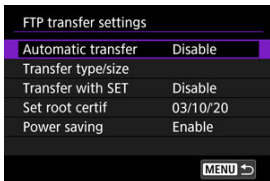

#### ● Automatic transfer

Select **[Enable]** for automatic image transfer to the FTP server immediately after shooting. You can continue shooting still photos as usual while images are being transferred.

#### ⚠ Caution

- Before shooting, make sure a card is in the camera. If you shoot without recording images, they cannot be transferred.
- Automatic transfer of movies during recording is not supported. After recording, transfer movies as described in [Transferring Multiple Images at Once](#) or [Adding a Caption Before Transfer](#).
- Images cannot be erased during image transfer.

#### 📄 Note

- During continuous shooting, images are transferred to the FTP server in the order they are captured.
- Captured images are also stored on the card.
- In the case of any images for which transfer fails or is interrupted, the camera attempts transfer again automatically when the connection is recovered (🔍). You can also try again later to manually transfer all of these images at once (🔍).
- Repeated automatic transfer is not attempted if network settings (such as FTP server settings) are changed before automatic FTP transfer begins.

- **Transfer type/size**

In **[JPEG size to trans.]**, you can specify the size of images to transfer. For example, to transfer smaller JPEGs when the camera is set to record larger JPEGs to one card and smaller JPEGs to the other, set to **[SmallerJPEG]**.

In **[RAW+JPEG transfer]** or **[RAW+HEIF transfer]**, you can specify the type of images to transfer.

 **Note**

- When the camera is set to record RAW images to one card and JPEGs or HEIFs to the other, specify which images to transfer in the **[RAW+JPEG transfer]** or **[RAW+HEIF transfer]** setting. Similarly, specify your transfer preference when RAW+JPEG images or RAW+HEIF images are simultaneously recorded to a single card.
- Captured images are also stored on the card.
- When images of the same size are recorded to both cards simultaneously, images recorded to the card selected for **[📷 Record/play]** or **[📷 Play]** in **[🔧: Record func+card/folder sel.]** are given priority for transfer.

- **Transfer with SET**

When set to **[Enable]**, simply press <  > to transfer the image displayed. You can continue shooting still photos as usual while images are being transferred.

 **Note**

- Movies cannot be transferred this way.

- **Set root certif**

If you specified **[FTPS]** FTP mode when configuring connection settings, the root certificate used by the FTPS server must be imported to the camera.

**Caution**

- Only the root certificate with a file name of "ROOT.CER," "ROOT.CRT," or "ROOT.PEM" can be imported to the camera.
- Only one root certificate file can be imported to the camera. Insert a card containing the root certificate file in advance.
- The priority card selected for **[Record/play]** or **[Play]** in **[Func: Record func+card/folder sel.]** is used to import a certificate.
- It may not be possible to trust servers you try to connect to in FTPS connections with a self-signed certificate.

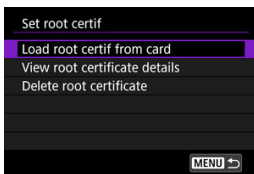

Select **[Load root certif from card]** to import the root certificate on the card.

To check who the root certificate was issued to and issued by, and the period of validity, select **[View root certificate details]**.

To delete the root certificate imported to the camera, select **[Delete root certificate]**.

- **Power saving**

When **[Enable]** is set and no image is transferred for a certain period, the camera will log off from the FTP server and end the Wi-Fi connection. The connection is re-established automatically when the camera is ready for image transfer again. If you prefer not to end the Wi-Fi connection, set to **[Disable]**.

## Transferring Multiple Images at Once

- ☑ [Selecting images to transfer](#)
- ☑ [Selecting multiple images](#)
- ☑ [Transferring RAW+JPEG or RAW+HEIF images](#)

After shooting, you can select multiple images and transfer them all at once, or you can transfer unsend images or images that could not be sent previously. You can continue shooting still photos as usual during transfer.

### ⚠ Caution

- Image transfer in progress is paused if you switch to movie mode. To resume image transfer, switch to photo mode.

## Selecting images to transfer

1. Select [(P): Image transfer].

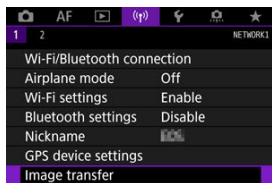

2. Select [Image sel./transfer].

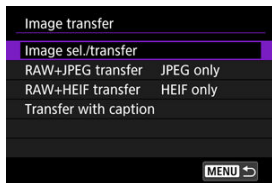

3. Select [FTP transfer].









4. Select [Sel.Image].



5. Select the image to transfer.



- Use the <  > dial to select an image to transfer, then press <  >.
- Use the <  > dial to add a checkmark [✓] in the upper left of the screen, then press <  >.
- You can turn the <  > dial counterclockwise to switch to select the images from 3-image display. To return to single-image display, turn the <  > dial clockwise.
- To select other images to transfer, repeat step 5.
- After image selection, press the < **MENU** > button.

6. Select [FTP transfer].



7. Select [OK].



- The selected images are transferred to the FTP server.

## Selecting multiple images

Multiple images can be transferred at once after you choose a selection method. You can continue shooting still photos as usual while images are being transferred.

### 1. Access the [Image sel./transfer] screen.

- Follow steps 1–3 in [Selecting Images to Transfer](#).

### 2. Select [Multiple].



### 3. Select a selection method to use.



- **Select range**



- Select [**Select range**]. Selecting the first and last images of the range marks all the images in the range with a checkmark [✓], and one copy of each image will be sent.
- To change the number of images in index display, turn the <  > dial.



● In a folder

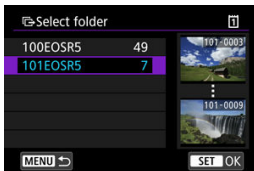

- Selecting [**Folder images failed transf.**] selects all images in the selected folder for which transfer failed.
- Selecting [**Folder images not transfer'd**] selects all unsent images in the selected folder.
- Selecting [**Clear folder transf. history**] clears the transfer history of images in the selected folder. After clearing the transfer history, you can select [**Folder images not transfer'd**] and transfer all images in the folder again.

● In a card



- Selecting [**Card images failed transfer**] selects all images in the selected card for which transfer failed.
- Selecting [**Card images not transferred**] selects all unsent images in the selected card.
- Selecting [**Clear card's transf. history**] clears the transfer history of images in the selected card. After clearing the transfer history, you can select [**Card images not transferred**] and transfer all images in the card again.

4. Select [**FTP transfer**].

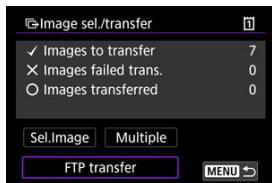

5. Select [OK].



- The selected images are transferred to the FTP server.

## Transferring RAW+JPEG or RAW+HEIF images

For RAW+JPEG or RAW+HEIF images, you can specify which image to transfer.

1. Select [(P): Image transfer].

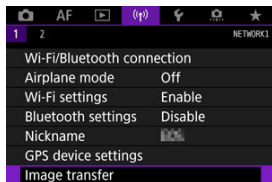

2. Select the type of images to transfer.

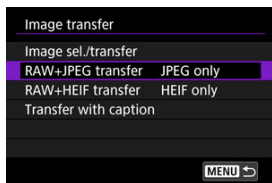

### ● RAW+JPEG transfer

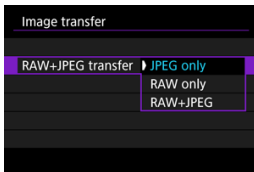

- Select **[RAW+JPEG transfer]**, then select **[JPEG only]**, **[RAW only]**, or **[RAW+JPEG]**.

### ● RAW+HEIF transfer

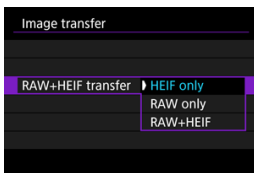

- Select **[RAW+HEIF transfer]**, then select **[HEIF only]**, **[RAW only]**, or **[RAW+HEIF]**.

### ⚠ Caution

- Some menu items are not available during image transfer.

### 📄 Note

- This setting is linked to **[RAW+JPEG transfer]** and **[RAW+HEIF transfer]** settings on the **[Transfer type/size]** screen (🔗).
- Image transfer in progress is paused if you switch to movie mode.

## Adding a Caption Before Transfer

You can add a registered caption to each image before transfer. This is convenient if you want to inform the recipient of the printing quantity, for example. Captions are also added to images saved to the camera.

- You can check captions added to images by examining the Exif information, in the user comments.
- Captions can be created and registered with EOS Utility (📷).

### 1. Select [(P): Image transfer].

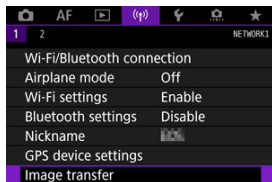

### 2. Select [Transfer with caption].

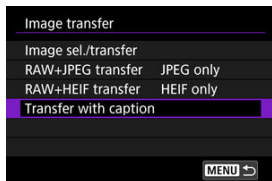

- The last image viewed is displayed.

### 3. Specify the caption.

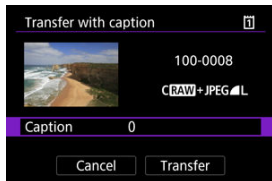

- Select [**Caption**], and on the screen displayed, select the content of the caption.

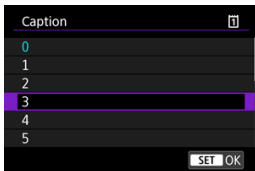

### 4. Select [**Transfer**].

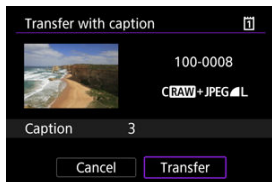

- The image is transferred with the caption. After transfer, display returns to the [**Image transfer**] screen.

#### ⚠ Caution

- Other images cannot be selected from the [**Transfer with caption**] screen. To select another image for transfer with a caption, view that image before following these steps.

## Auto Retry If Transfer Fails

If transfer fails, the camera's access lamp blinks in red. In this case, the following screen is displayed after you press the <MENU> button and select [(1): **Wi-Fi/Bluetooth connection**].

To resolve the error displayed, see the troubleshooting information (🔗).

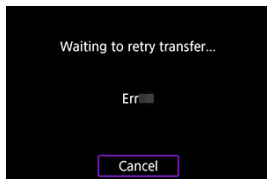

Once you have resolved the issue, the images that could not be sent initially will be transferred automatically. With this option activated, transfer is attempted again automatically after failure, whether automatic transfer is used or captured images are transferred manually via FTP. Note that if you cancel transfer or turn the camera off, auto retry is not attempted.

See [Transferring Multiple Images at Once](#) and transfer images as needed.

### Note

- To automatically log off and end the Wi-Fi connection after transfer, you can configure power-saving on the [**FTP transfer settings**] screen (🔗).
- If you prefer not to end the Wi-Fi connection, set [**Power saving**] on the [**FTP transfer settings**] screen (🔗) to [**Disable**].

## Viewing Transferred Images

---

Images transferred to the FTP server are stored in the following folder as specified in the FTP server settings.

### Target folder of the FTP server

- Under the default settings of the FTP server, images are stored in [C drive] → [Inetpub] folder → [ftproot] folder, or in a subfolder of this folder.
- If the root folder of the transfer destination has been changed in the FTP server settings, ask the FTP server administrator where images are transferred.



# Wi-Fi Connection via Access Points

[☑ Camera Access Point Mode](#)

[☑ Manual IP Address Setup](#)

This section describes how to join a Wi-Fi network via an access point compatible with WPS (PBC mode).

First, check the position of the WPS button and how long to press it. It may take approx. 1 min. to establish a Wi-Fi connection.

---

## 1. Set Wi-Fi settings to [Enable].

- See steps 1–4 in [Connecting to a Bluetooth-Compatible Smartphone via Wi-Fi](#).

## 2. Select [(P): Wi-Fi/Bluetooth connection].

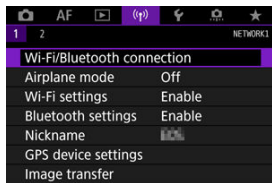

## 3. Select an option.

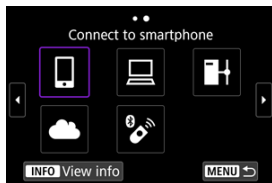

- If the history (☑) is displayed, switch screens with the < ⌂ > dial or < \* >.

#### 4. Select [Add a device to connect to].



- The following message is displayed if you have selected [📱 **Connect to smartphone**]. If Camera Connect is already installed, select [**Do not display**].

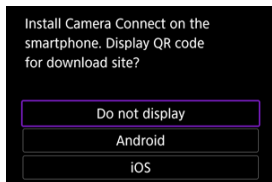

- On the [**Connect to smartphone**] screen displayed next, select [**Connect via Wi-Fi**].

#### 5. Select [Switch network].

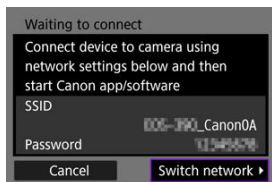

- Displayed when [📱] or [🖨️] is selected.

## 6. Select [Connect with WPS].

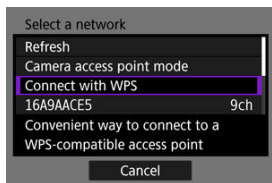

### Note

- For [Camera access point mode] displayed in step 6, see [Camera Access Point Mode](#).

## 7. Select [WPS (PBC mode)].

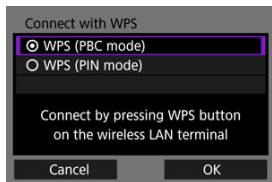

- Select [OK].

## 8. Connect to the access point via Wi-Fi.

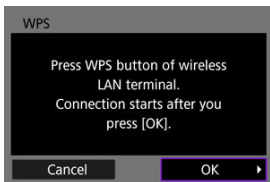

- Press the access point's WPS button.
- Select **[OK]**.

## 9. Select **[Auto setting]**.

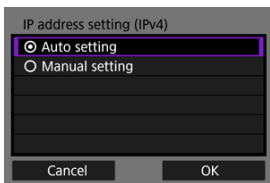

- Select **[OK]** to access the setting screen for the Wi-Fi function.
- If an error occurs with **[Auto setting]**, see [Manual IP Address Setup](#).

## 10. Specify the settings for the Wi-Fi function.

### [📱 Connect to smartphone]

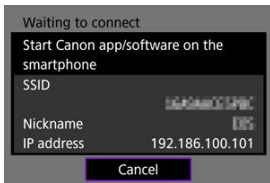

- On the smartphone's Wi-Fi setting screen, tap the SSID (network name) shown on the camera screen, then enter the password of the access point for the connection.

Go to step 8 in [Wi-Fi Connection without Using Bluetooth](#).

### [🖨️ Remote control (EOS Utility)]

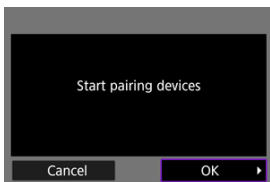

Go to step 7 or 8 in [Operating the Camera Using EOS Utility](#).

### [📁 Transfer images to FTP server]

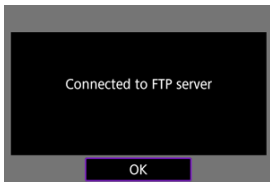

Go to step 10 in [Connection via Access Points](#).

### [📶 Upload to Web service]

Go to step 5 in [Registering Image.Canon and Setting Up Auto Send](#).

## Camera Access Point Mode

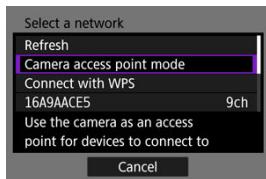

Camera access point mode is a connection mode for connecting the camera directly to each device via Wi-Fi. Displayed when [📺], [🖨️], or [📶] is selected after [(Ⓜ️): **Wi-Fi/Bluetooth connection**].

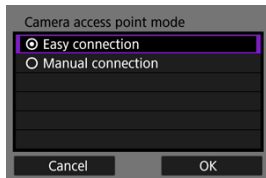

- **Easy connection**

Use the other device to establish a Wi-Fi connection with the SSID shown on the camera screen.

- **Manual connection**

Enter the SSID of the other device to establish a connection. Follow the instructions on the camera screen to complete the connection settings.

## Manual IP Address Setup

The options displayed vary depending on the Wi-Fi function.

### 1. Select [Manual setting].

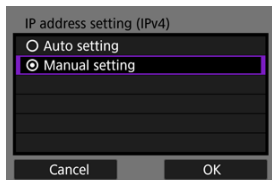

- Select [OK].

### 2. Select an option.

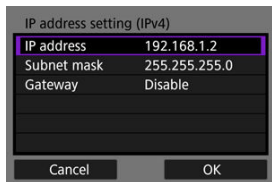



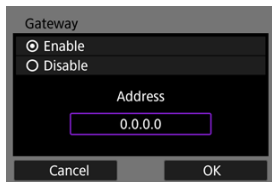

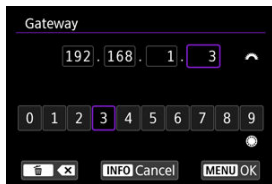

- Select an option to access the screen for numerical input.
- To use a gateway, select [Enable], then select [Address].



### 3. Enter the number.



- Turn the <  > dial to move the input position in the upper area, and use the <  > <  > <  > dials or <  > to select numbers to enter. Press <  > to enter the selected number.
- To set the entered numbers and return to the screen for step 2, press the < **MENU** > button.

### 4. Select [OK].

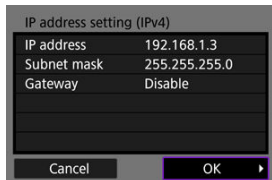

- When you have completed setting the necessary items, select [**OK**].
- If you are not sure what to enter, see [Checking Network Settings](#), or ask the network administrator or another person knowledgeable about the network.



# Connecting to a Wireless Remote Control

## [Canceling the Pairing](#)

This camera can also be connected to Wireless Remote Control BR-E1 (sold separately, ) via Bluetooth for remote control shooting.

---

### 1. Set Wi-Fi settings to [Enable].

- See steps 1–4 in [Connecting to a Bluetooth-Compatible Smartphone via Wi-Fi](#).

### 2. Select []: Wi-Fi/Bluetooth connection].

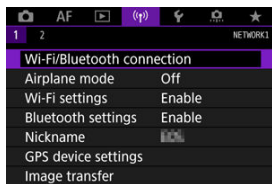

### 3. Select [] Connect to Wireless Remote].

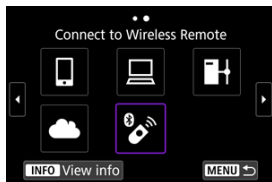

4. Select [Add a device to connect to].

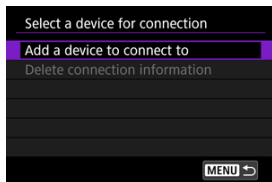

5. Press <SET>.



6. Pair the devices.

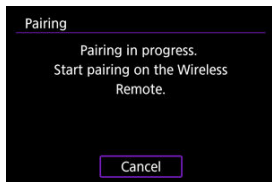

- When the [Pairing] screen appears, press and hold the <W> and <T> buttons on the BR-E1 simultaneously for at least 3 sec.
- After a message confirms that the camera is paired with the BR-E1, press <SET>.

## 7. Set up the camera for remote shooting.

- When shooting still photos, select [] or [] as the drive mode ().
- For movie recording, set [: Remote control] to [Enable].
- For instructions after the pairing is complete, refer to the BR-E1's Instruction Manual.

### Caution

- Bluetooth connections consume battery power even after the camera's auto power off is activated.

### Note

- When you will not use Bluetooth, setting this function to [Disable] in step 1 is recommended.

## Canceling the Pairing

Before pairing with a different BR-E1, clear the information about the connected remote control.

1. Select [**(P)**: Wi-Fi/Bluetooth connection].

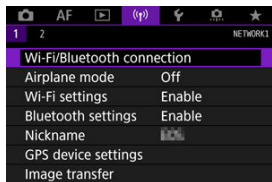

2. Select [**(P)**: Connect to Wireless Remote].

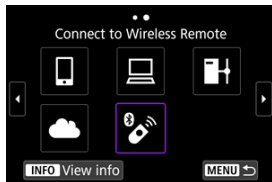

3. Select [**(P)**: Delete connection information].

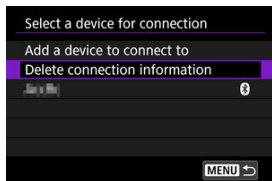

4. Select [OK].

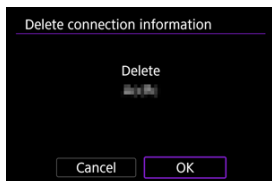

# Reconnecting via Wi-Fi

---

Follow these steps to reconnect via Wi-Fi using registered connection settings.

---

1. Select [(Wi-Fi): Wi-Fi/Bluetooth connection].

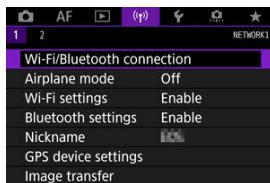

2. Select an option.



- Select an option to connect to via Wi-Fi from the displayed history. If the option is not displayed, use the < > dial to switch screens.
- If [**Connection history**] is set to [**Do not display**], the history will not be displayed (🔒).

### 3. Operate the connected device.

#### Smartphone

- Start Camera Connect.
- If the smartphone's connection destination has been changed, restore the setting to connect via Wi-Fi to the camera or the same access point as the camera.  
When directly connecting the camera to a smartphone via Wi-Fi, “\_Canon0A” is displayed at the end of the SSID.

#### Computer

- On the computer, start the EOS software.
- If the computer's connection destination has been changed, restore the setting to connect via Wi-Fi to the camera or the camera's access point.  
When directly connecting the camera to a computer via Wi-Fi, “\_Canon0A” is displayed at the end of the SSID.

#### FTP transfer

- If the FTP server's settings were changed to connect to other devices, restore the settings to connect via Wi-Fi to the camera or the camera's access point.  
When the camera is directly connected to an FTP server via Wi-Fi, “\_Canon0A” is displayed at the end of the SSID.

# Registering Multiple Connection Settings

You can register up to 10 connection settings for the wireless communication functions.

1. Select [**(Wi-Fi/Bluetooth)**: Wi-Fi/Bluetooth connection].

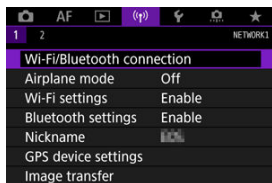

2. Select an option.

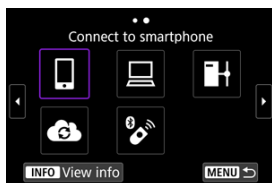

- If the history (**(Wi-Fi/Bluetooth)**) is displayed, switch screens with the < **(Wi-Fi/Bluetooth)** > < **(Wi-Fi/Bluetooth)** > dial or < **(Wi-Fi/Bluetooth)** >.
- For details on [**(Wi-Fi/Bluetooth)** Connect to smartphone], see [Connecting to a Smartphone](#).
- For details on [**(Wi-Fi/Bluetooth)** Remote control (EOS Utility)], see [Connecting to a Computer via Wi-Fi](#).
- For details on [**(Wi-Fi/Bluetooth)** Transfer images to FTP server], see [Image Transfer to FTP Servers](#).
- For details on [**(Wi-Fi/Bluetooth)** Upload to Web service], see [Sending Images to a Web Service](#).





#### Note

- To delete connection settings, see [Changing or Deleting Connection Settings](#).

# Airplane Mode

---

You can temporarily disable Wi-Fi and Bluetooth functions.

---

1. Select []: Airplane mode].

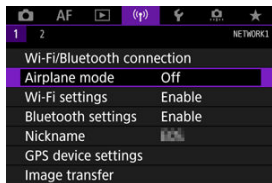

2. Set to [On].

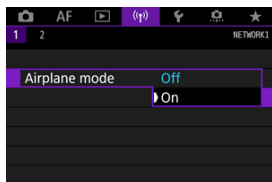

- [] is displayed on the screen.

## Note

- [] may not be displayed in still photo shooting, movie recording, or playback, depending on display settings. If it is not displayed, press the <INFO> button repeatedly to access detailed information display.

# Wi-Fi Settings

---

1. Select [(Wi-Fi icon): Wi-Fi settings].

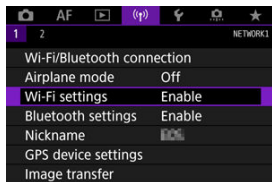

2. Select an option.

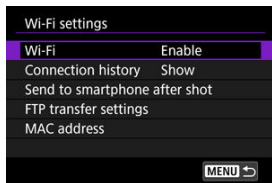

- **Wi-Fi**

When the use of electronic devices and wireless devices is prohibited, such as on board airplanes or in hospitals, set it to **[Disable]**.

- **Connection history**

You can set the connection history for devices connected via Wi-Fi to **[Show]** or **[Do not display]**.

- **Send to smartphone after shot**

Images can be transferred to a smartphone automatically (📱).

- **FTP transfer settings**

Images can be transferred to an FTP server (🌐).

- **MAC address**

You can check the MAC address of the camera.

# Bluetooth Settings

---

1. Select [(P): Bluetooth settings].

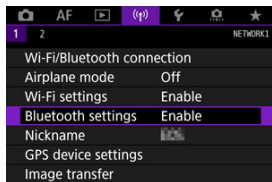

2. Select an option.

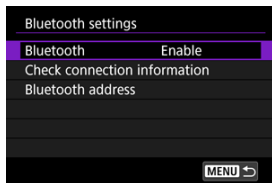

- **Bluetooth**  
If you will not use the Bluetooth function, select [**Disable**].
- **Check connection information**  
You can check the name and communication status of the paired device.
- **Bluetooth address**  
You can check the camera's Bluetooth address.

# Nickname

---

You can change the camera nickname (displayed on smartphones and other cameras) as needed.

---

1. Select [(?)]: Nickname].

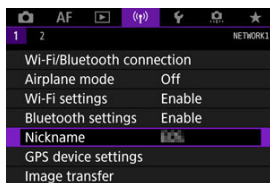

2. Enter text using the [Virtual Keyboard Operations](#).

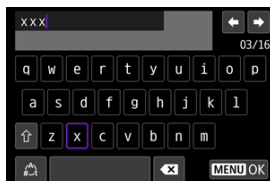

- When you finish entering characters, press the < MENU > button.

# GPS Device Settings

---

[GP-E2](#)

[Smartphone](#)

[GPS Connection Display](#)

You can geotag images with GPS Receiver GP-E2 (sold separately) or a Bluetooth-compatible smartphone.

---

## GP-E2

---

### 1. Attach GP-E2 to the camera.

- Attach GP-E2 to the camera's hot shoe and turn it on. For details, refer to the GP-E2 Instruction Manual.

### 2. Select [(P): GPS device settings].

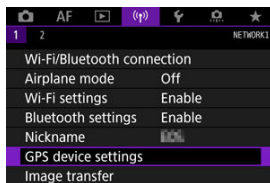

3. In [Select GPS device], select [GPS receiver].

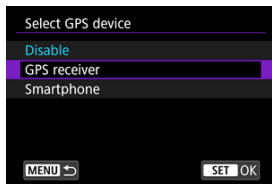

4. Take the picture.

- For details on [Set up], refer to the GP-E2 Instruction Manual.

**Caution**

**Precautions when using GP-E2**

- Before use, check the countries and regions where use of GPS is allowed, and follow local regulations.
- Update the GP-E2 firmware to Ver. 2.0.0 or later.  
Firmware updating requires an interface cable. For updating instructions, visit the Canon website.
- GP-E2 cannot be connected to the camera with a cable.
- The camera does not record the shooting direction.

## Smartphone

Complete these settings after installing the dedicated Camera Connect app (📷) on the smartphone.

1. On the smartphone, activate location services.

2. Establish a Bluetooth connection.

- Start Camera Connect and pair the camera and smartphone via Bluetooth.

3. Select [(📶): GPS device settings].

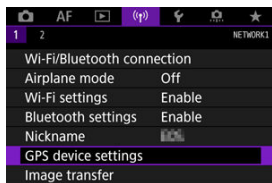

4. In [Select GPS device], select [Smartphone].

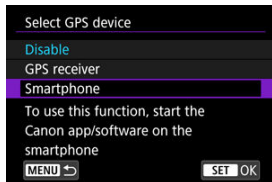

5. Take the picture.

- Images are geotagged with the information from the smartphone.



## GPS Connection Display

You can check the status of smartphone location information acquisition in the GPS connection icon on the screens for still photo shooting or movie recording (📍 and 📍, respectively).

- Gray: Location services are off
- Blinking: Location information cannot be acquired
- On: Location information acquired

For details on how GPS connection status is indicated when GP-E2 is used, refer to the GP-E2 Instruction Manual.

### Geotagging images as you shoot

Images you shoot while the GPS icon is on are geotagged.

### Geotagging information

You can check the location information added to your shots on the shooting information screen (📍).

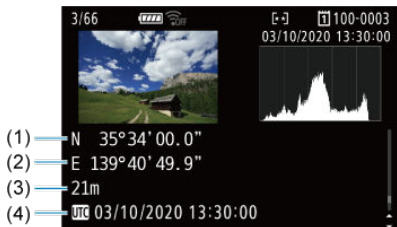

- (1) Latitude
- (2) Longitude
- (3) Elevation
- (4) UTC (Coordinated Universal Time)

 **Caution**

- The smartphone can acquire location information only while it is paired with the camera via Bluetooth.
- Direction information is not acquired.
- Acquired location information may not be accurate, depending on traveling conditions or smartphone status.
- It may take some time to acquire location information from the smartphone after you turn the camera on.
- Location information is no longer acquired after any of the following operations.
  - Pairing with a wireless remote control via Bluetooth
  - Turning the camera off
  - Quitting Camera Connect
  - Deactivating location services on the smartphone
- Location information is no longer acquired in any of the following situations.
  - The camera power turns off
  - The Bluetooth connection is ended
  - The smartphone's remaining battery level is low

 **Note**

- Coordinated Universal Time, abbreviated as UTC, is essentially the same as Greenwich Mean Time.
- For movies, the GPS information initially acquired is added.

# Changing or Deleting Connection Settings

To change or delete the connection settings, terminate the Wi-Fi connection first.

1. Select [(Wi-Fi/Bluetooth connection)].

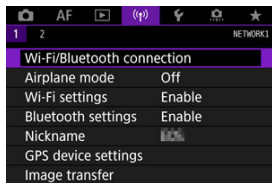

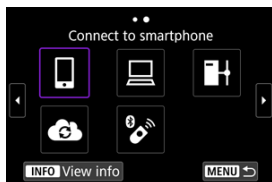

2. Select an option.

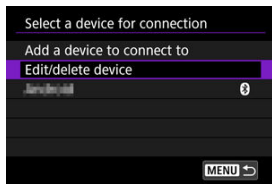

- If the history (📄) is displayed, switch screens with the < 🌐 > < 📄 > dial or < ✨ >.

### 3. Select [Edit/delete device].



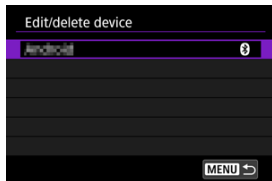

- You can change the Bluetooth connection by selecting a smartphone labeled with  in gray. After the [Connect to smartphone] screen is displayed, select [Pair via Bluetooth], then press < > on the next screen.

### 4. Select the device for which to change or delete the connection settings.

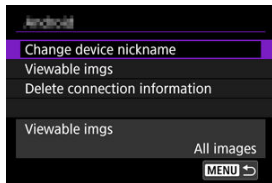

### 5. Select an option.



- Change or delete the connection settings on the displayed screen.
- **Change device nickname**  
You can change the nickname using the virtual keyboard ().

- **Viewable imgs** (🔗)

Displayed when [📱 **Connect to smartphone**] is selected. Settings will appear at the bottom of the screen.

- **Delete connection information**

When deleting connection information for a paired smartphone, also delete the camera information registered on the smartphone (🔗).

# Resetting Communication Settings

---

All wireless communication settings can be deleted. By deleting the wireless communication settings, you can prevent their information from being exposed when you lend or give your camera to other people.

---

1. Select **[ⓘ]: Reset communication settings**.

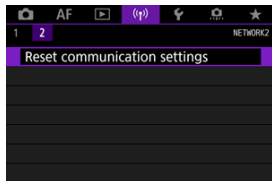

2. Select **[OK]**.



## ⚠ Caution

- If you have paired the camera with a smartphone, on the smartphone's Bluetooth settings screen, delete the connection information of the camera for which you restored default wireless communication settings.

## 📄 Note

- All wireless communication settings can be cleared by selecting the **[Communication settings]** option for **[Other settings]** in **[ⓘ: Reset camera]**.

## View Info Screen

---

You can check error details and the camera's MAC address.

---

1. Select [(P): Wi-Fi/Bluetooth connection].

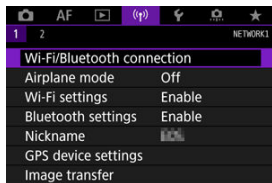

2. Press the <INFO> button.

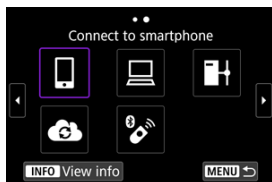

- The [View info] screen will appear.

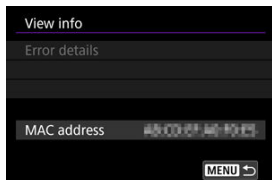



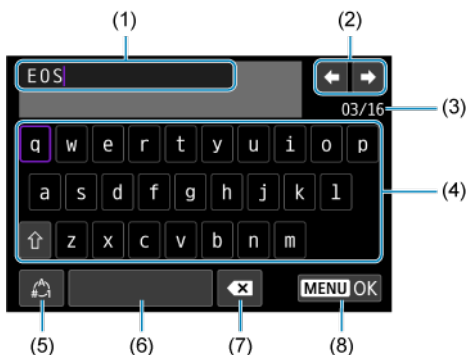

- When an error has occurred, press <SET> to display the error content.

## Virtual Keyboard Operations



- 
- |     |   |
|-----|---|
| (1) | Input area, for entering text             |
| (2) | Cursor keys, for moving in the input area |
| (3) | Current no. of characters/no. available   |
| (4) | Keyboard                                  |
| (5) | Switch input modes                        |
| (6) | Space                                     |
| (7) | Delete a character in the input area      |
| (8) | Exit input                                |
- 

- Use the <  > dial to move within (1).
- Use <  > or the <  > or <  > dial to move within (2) and (4)–(7).
- Press <  > to confirm input or when switching input modes.



## Responding to Error Messages

---

When an error occurs, display the details of the error by following one of the procedures below. Then, eliminate the cause of the error by referring to the examples shown in this chapter.

- On the **[View info]** screen, press <  >.
- Select **[Error details]** on the **[Wi-Fi on]**.

Click the following error numbers to jump to the corresponding section.

<a href="#">11</a>	<a href="#">12</a>						
<a href="#">21</a>	<a href="#">22</a>	<a href="#">23</a>					
<a href="#">41</a>	<a href="#">43</a>	<a href="#">44</a>	<a href="#">45</a>	<a href="#">46</a>	<a href="#">47</a>	<a href="#">48</a>	
<a href="#">61</a>	<a href="#">63</a>	<a href="#">64</a>	<a href="#">65</a>	<a href="#">66</a>	<a href="#">67</a>	<a href="#">68</a>	<a href="#">69</a>
<a href="#">91</a>							
<a href="#">121</a>	<a href="#">125</a>	<a href="#">126</a>	<a href="#">127</a>				
<a href="#">151</a>	<a href="#">152</a>						



### Note

- When an error occurs, **[Err\*\*]** is displayed in the upper right of the **[Wi-Fi/Bluetooth connection]** screen. It disappears when the camera's power is set to < **OFF** >.

## 11: Connection target not found

- **In the case of [📷], is Camera Connect running?**
  - Establish a connection using Camera Connect (🔗).
- **In the case of [💻], is EOS Utility running?**
  - Start EOS Utility and try to connect again (🔗).
- **Are the camera and the access point set to use the same encryption key for authentication?**
  - This error occurs if the encryption keys do not match when the authentication method for encryption is **[Open system]**.  
Check upper- and lower-case letters, and make sure the correct encryption key for authentication is set on the camera (🔗).

## 12: Connection target not found

- **Are the target device and access point turned on?**
  - Turn on the target device and access point, then wait a while. If a connection still cannot be established, perform the procedures to establish the connection again.

## 21: No address assigned by DHCP server

### What to check on the camera

- **On the camera, IP address is set to [Auto setting]. Is this the correct setting?**
  - If no DHCP server is used, specify the settings after setting the IP address to [Manual setting] on the camera (🔗).

### What to check on the DHCP server

- **Is the power of the DHCP server on?**
  - Turn on the DHCP server.
- **Are there enough addresses for assignment by the DHCP server?**
  - Increase the number of addresses assigned by the DHCP server.
  - Remove devices assigned addresses by the DHCP server from the network to reduce the number of addresses in use.
- **Is the DHCP server working correctly?**
  - Check the DHCP server settings to make sure it is working correctly as a DHCP server.
  - If applicable, ask your network administrator to ensure the DHCP server is available.

## 22: No response from DNS server

### What to check on the camera

- **On the camera, the DNS address is set to [Manual setting]. Is this the correct setting?**
  - If no DNS server is used, set the camera's DNS address setting to [Disable] (🔗).
- **On the camera, does the DNS server's IP address setting match the server's actual address?**
  - Configure the IP address on the camera to match the actual DNS server address (🔗, 🔗).

### What to check on the DNS server

- **Is the power of the DNS server on?**
  - Turn on the DNS server.
- **Are the DNS server settings for IP addresses and the corresponding names correct?**
  - On the DNS server, make sure IP addresses and the corresponding names are entered correctly.
- **Is the DNS server working correctly?**
  - Check the DNS server settings to make sure it is working correctly as a DNS server.
  - If applicable, ask your network administrator to ensure the DNS server is available.

### What to check on the network as a whole

- **Does your network include a router or similar device that serves as a gateway?**
  - If applicable, ask your network administrator for the network gateway address and set it on the camera (🔗, 🔗).
  - Make sure that the gateway address setting is correctly entered on all network devices including the camera.

## 23: Device with same IP address exists on selected network

- **Is another device on the camera network using the same IP address as the camera?**
  - Change the camera's IP address to avoid using the same address as another device on the network. Otherwise, change the IP address of the device that has a duplicate address.
  - If the camera's IP address is set to **[Manual setting]** in network environments using a DHCP server, change the setting to **[Auto setting]** (🔗).



### Note

#### Responding to error messages 21–23

- Also check the following points when responding to errors numbered 21–23.  
**Are the camera and the access point set to use the same password for authentication?**
  - This error occurs if the passwords do not match when the authentication method for encryption is set to **[Open system]**. Check upper- and lower-case letters, and make sure the correct password for authentication is set on the camera (🔗).

## 41: Cannot connect to FTP server

### What to check on the camera

- **The camera's proxy server setting is [Enable]. Is this the correct setting?**
  - If no proxy server is used, set the camera's proxy server setting to **[Disable]** (🔗).
- **Do the camera's [Address setting] and [Port No.] settings match those of the proxy server?**
  - Configure the camera's proxy server address and port number to match those of the proxy server (🔗).
- **Are the camera's proxy server settings correctly set on the DNS server?**
  - Make sure the proxy server's **[Address]** is correctly set on the DNS server.
- **On the camera, does the FTP server's IP address setting match the server's actual address?**
  - Configure the IP address on the camera to match the actual FTP server address (🔗).
- **Are the camera and the access point set to use the same encryption key for authentication?**
  - This error occurs if the encryption keys do not match when the authentication method for encryption is **[Open system]**.  
Check upper- and lower-case letters, and make sure the correct encryption key for authentication is set on the camera (🔗).
- **On the camera, does the [Port number setting] for the FTP server match the actual port number of the FTP server?**
  - Configure the same port number (usually 21 for FTP/FTPS or 22 for SFTP) on the camera and FTP server. Configure the port number on the camera to match the actual FTP server port number (🔗).
- **Are the camera's FTP server settings correctly set on the DNS server?**
  - Make sure the FTP server's **[Server name]** is correctly set on the DNS server. Make sure the **[Server name]** for the FTP server is correctly set on the camera (🔗).

### What to check on the FTP server

- **Is the FTP server working correctly?**
  - Configure the computer correctly to function as an FTP server.
  - If applicable, ask your network administrator for the FTP server address and port number, then set them on the camera.
- **Is the FTP server on?**
  - Turn on the FTP server. The server may have been turned off because of an energy-saving mode.

- **On the camera, does the FTP server's IP address setting (in [Address]) match the server's actual address?**
  - Configure the IP address on the camera to match the actual FTP server address (🔗).
- **Is a firewall or other security software enabled?**
  - Some security software uses a firewall to restrict access to the FTP server. Change the firewall settings to allow access to the FTP server.
  - You may be able to access the FTP server by setting [Passive mode] to [Enable] on the camera (🔗).
- **Are you connecting to the FTP server via a broadband router?**
  - Some broadband routers use a firewall to restrict access to the FTP server. Change the firewall settings to allow access to the FTP server.
  - You may be able to access the FTP server by setting [Passive mode] to [Enable] on the camera (🔗).

## What to check on the proxy server

- **Is the proxy server on?**
  - Turn on the proxy server.
- **Is the proxy server working correctly?**
  - Check the proxy server settings to make sure the server is working correctly as a proxy server.
  - If applicable, ask your network administrator for the proxy server's address setting and port number, then set them on the camera.

## What to check on the network as a whole

- **Does your network include a router or similar device that serves as a gateway?**
  - If applicable, ask your network administrator for the network gateway address and set it on the camera (🔗, 🔗).
  - Make sure that the gateway address setting is correctly entered on all network devices including the camera.

#### 43: Cannot connect to FTP server. Error code received from server.

##### What to check on the proxy server

- **Is the proxy server on?**
  - Turn on the proxy server.
- **Is the proxy server working correctly?**
  - Check the proxy server settings to make sure the server is working correctly as a proxy server.
  - If applicable, ask your network administrator for the proxy server's address setting and port number, then set them on the camera.

##### What to check on the network as a whole

- **Does your network include a router or similar device that serves as a gateway?**
  - If applicable, ask your network administrator for the network gateway address and set it on the camera (📎, 📎).
  - Make sure that the gateway address setting is correctly entered on all network devices including the camera.

##### What to check on the FTP server

- **Have you exceeded the maximum number of FTP server connections?**
  - Disconnect some network devices from the FTP server or increase the maximum number of connections.

#### 44: Cannot disconnect FTP server. Error code received from server.

- **This error occurs from a failure to disconnect from the FTP server for some reason.**
  - Restart the FTP server and camera.



### **What to check on the camera**

- **On the camera, is the [Login name] set correctly?**
  - Check the login name for accessing the FTP server. Check upper- and lower-case letters, and make sure the correct login name is set on the camera (🔗).
- **On the camera, is the [Login password] set correctly?**
  - Check upper- and lower-case letters, and make sure the correct login password is set on the camera (🔗).

### **What to check on the FTP server**

- **Do the user rights for the FTP server allow reading, writing, and log access?**
  - Configure the FTP server's user rights to allow reading, writing, and log access.
- **Is the folder specified as the transfer destination on the FTP server named with ASCII characters?**
  - Use ASCII characters for the folder name.

## 46: For the data session, error code received from FTP server

### What to check on the FTP server

- **The connection was terminated by the FTP server.**
  - Restart the FTP server.
- **Do the user rights for the FTP server allow reading, writing, and log access?**
  - Configure the FTP server's user rights to allow reading, writing, and log access.
- **Do user rights allow access to the target folder on the FTP server?**
  - Configure the user rights for access to the target folder on the FTP server to allow saving images from the camera.
- **Is the FTP server on?**
  - Turn on the FTP server. The server may have been turned off because of an energy-saving mode.
- **Is the hard disk of the FTP server full?**
  - Increase available space on the hard disk.

## 47: Image file transfer completion not confirmed by FTP server

- **This error occurs from a failure to receive confirmation from the FTP server that image file transfer is complete for some reason.**
  - Restart the FTP server and camera and send the images again.

## 48: Security of the connection to the target server cannot be verified. If you trust this server and connect, set [Trust target server] to [Enable].

- **This error occurs from a failure to confirm security of the target server connection when connecting via FTPS.**
  - Confirm that the certificate is set correctly.
  - Change [Trust target server] to [Enable] if you prefer to trust target servers regardless of certificate settings.

## 61: Selected SSID wireless LAN network not found

- **Are any obstacles blocking the line of sight between the camera and the antenna of the access point?**
  - Move the antenna of the access point to a position clearly visible from the point of view of the camera.

### What to check on the camera

- **Does the SSID set on the camera match that of the access point?**
  - Check the SSID at the access point, then set the same SSID on the camera (🔗).

### What to check at the access point

- **Is the access point turned on?**
  - Turn on the power of the access point.
- **If filtering by MAC address is active, is the MAC address of the camera in use registered at the access point?**
  - Register the MAC address of the camera used to the access point (🔗).

## 63: Wireless LAN authentication failed

- **Are the camera and the access point set to use the same encryption key for authentication?**
  - Check upper- and lower-case letters, and make sure the correct encryption key for authentication is set on the camera (🔗).
- **Are the camera and the access point set to use the same password for authentication?**
  - Check upper- and lower-case letters, and make sure the correct password for authentication is set on the camera.
- **If filtering by MAC address is active, is the MAC address of the camera in use registered at the access point?**
  - Register the MAC address of the camera at the access point. The MAC address can be checked on the **[MAC address]** screen (🔗).

## 64: Cannot connect to wireless LAN terminal

- **Are the camera and the access point set to use the same encryption method?**
  - The camera supports the following encryption methods: WEP, TKIP, and AES (🔗).
- **If filtering by MAC address is active, is the MAC address of the camera in use registered at the access point?**
  - Register the MAC address of the camera used to the access point. The MAC address can be checked on the [MAC address] screen (🔗).

## 65: Wireless LAN connection lost

- **Are any obstacles blocking the line of sight between the camera and the antenna of the access point?**
  - Move the antenna of the access point to a position clearly visible from the point of view of the camera.
- **The wireless LAN connection was lost, for some reason, and the connection cannot be restored.**
  - The following are possible reasons: excessive access to the access point from another device, a microwave oven or similar appliance in use nearby (interfering with IEEE 802.11n/g/b (2.4 GHz band)), or influence of rain or high humidity.

## 66: Incorrect wireless LAN password

- **Are the camera and the access point set to use the same encryption key for authentication?**
  - Check upper- and lower-case letters, and make sure the correct encryption key for authentication is set on the camera and access point (🔗).  
Note that if the encryption authentication method is [Open system], an Error 41 is displayed (🔗).

## 67: Incorrect wireless LAN encryption method

- **Are the camera and the access point set to use the same encryption method?**
  - The camera supports the following encryption methods: WEP, TKIP, and AES (🔗).
- **If filtering by MAC address is active, is the MAC address of the camera in use registered at the access point?**
  - Register the MAC address of the camera used to the access point. The MAC address can be checked on the [MAC address] screen (🔗).

### 68: Cannot connect to wireless LAN terminal. Retry from the beginning.

- **Did you hold down the access point's WPS (Wi-Fi Protected Setup) button for the specified period of time?**
  - Hold down the WPS button for the period of time specified in the access point's instruction manual.
- **Are you trying to establish a connection near the access point?**
  - Try establishing the connection when both devices are within reach of each other.

### 69: Multiple wireless LAN terminals have been found. Cannot connect. Retry from the beginning.

- **Connection is in progress by other access points in Pushbutton Connection mode (PBC mode) of WPS (Wi-Fi Protected Setup).**
  - Wait a while before trying to establish the connection.

### 91: Other error

- **A problem other than error code number 11 to 83 occurred.**
  - Turn the camera's power switch off and on.

### 121: Not enough free space on server

- **The target Web server does not have enough free space.**
  - Delete unnecessary images on the Web server, check the free space on the Web server, then try sending the data again.

### 125: Check the network settings

- **Is the network connected?**
  - Check the connection status of the network.

### 126: Could not connect to server

- **image.canon is under maintenance or temporarily busy.**
  - Try accessing the service again later.

## 127: An error has occurred

- **A problem other than error code number 121 to 126 occurred while the camera is connected to the Web service.**
  - Try again to establish the Wi-Fi connection to image.canon.

## 151: Transmission canceled

- **Automatic image transfer was somehow interrupted.**
  - To resume automatic image transfer, set the camera's power switch to < **OFF** >, and then set it to < **ON** >.

## 152: Card's write protect switch is set to lock

- **Is the card's write-protect switch set to the locked position?**
  - Slide the card's write-protect switch to the writing position.

## Wireless Communication Function Precautions

If the transmission rate drops, the connection is lost, or other problems occur when using the wireless communication functions, try the following corrective actions.

### Distance between the camera and the smartphone

If the camera is too far from the smartphone, a Wi-Fi connection may not be established even when Bluetooth connection is possible. In this case, bring the camera and the smartphone closer together, then establish a Wi-Fi connection.

### Installation location of access point antenna

- When using indoors, install the device in the room where you are using the camera.
- Install the device where people or objects do not come between the device and the camera.

### Nearby electronic devices

If the Wi-Fi transmission rate drops because of the influence of the following electronic devices, stop using them or move further away from the devices to transmit communication.

- The camera communicates over Wi-Fi via IEEE 802.11b/g/n using radio waves in the 2.4 GHz band. For this reason, the Wi-Fi transmission rate will drop if there are Bluetooth devices, microwave ovens, cordless telephones, microphones, smartphones, other cameras, or similar devices operating on the same frequency band nearby.

### Precautions for using multiple cameras

- When connecting multiple cameras to one access point via Wi-Fi, make sure the cameras' IP addresses are different.
- When multiple cameras are connected to one access point via Wi-Fi, the transmission rate drops.
- When there are multiple IEEE 802.11b/g/n (2.4 GHz band) access points, leave a gap of five channels between each Wi-Fi channel to reduce radio wave interference. For example, use channels 1, 6, and 11, channels 2 and 7, or channels 3 and 8.

### Using wireless remote control BR-E1

- BR-E1 cannot be used while the camera and smartphone are paired via Bluetooth. Change the camera connection to the wireless remote control in [**Connect to Wireless Remote**] under [(1): **Wi-Fi/Bluetooth connection**].

## Security

---

If security settings have not been properly set, the following problems may occur.

- **Transmission monitoring**  
Third parties with malicious intent may monitor wireless LAN transmissions and attempt to acquire the data you are sending.
- **Unauthorized network access**  
Third parties with malicious intent may gain unauthorized access to the network you are using to steal, modify, or destroy information. Additionally, you could fall victim to other types of unauthorized access such as impersonation (where someone assumes an identity to gain access to unauthorized information) or springboard attacks (where someone gains unauthorized access to your network as a springboard to cover their tracks when infiltrating other systems).

It is recommended to make use of the systems and functions to thoroughly secure your network, preventing these types of problems from occurring.



## Checking Network Settings

---

### Windows

Open the Windows [**Command Prompt**], then enter ipconfig/all and press the <Enter> key. In addition to the IP address assigned to the computer, the subnet mask, gateway, and DNS server information are also displayed.

### macOS

In macOS, open the [**Terminal**] application, enter ifconfig -a, and press the <Return> key. The IP address assigned to the computer is indicated in the [**enX**] item (X: number) next to [**inet**], in the format "\*\*\*\*.\*\*\*.\*\*\*.\*\*\*".

For information about the [**Terminal**] application, refer to the macOS help.

To avoid using the same IP address for the computer and other devices on the network, change the rightmost number when configuring the IP address assigned to the camera in the processes described in [Manual IP Address Setup](#).

Example: 192.168.1.**10**

# Wireless Communication Status

Wireless communication status can be checked on the screen.



## Quick Control screen Information display screen during playback



- (1) Wi-Fi function
- (2) Bluetooth function
- (3) Wireless signal strength

Communication Status		Screen	
		Wi-Fi Function	Wireless Signal Strength
Not connected	Wi-Fi: Disable	Wi-Fi OFF	Off
	Wi-Fi: Enable	Wi-Fi OFF	
Connecting		Wi-Fi (Blinking)	Partial signal strength
Connected		Wi-Fi	Full signal strength
Sending data		Wi-Fi	Full signal strength
Connection error		Wi-Fi (Blinking)	Partial signal strength

## Bluetooth Function Indicator

Bluetooth Function	Connection Status	Screen
Other than [Disable]	Bluetooth connected	
	Bluetooth not connected	
[Disable]	Bluetooth not connected	Not displayed

## Set-up

---

This chapter describes menu settings on the set-up ([F]) tab.

☆ to the right of titles indicates functions only available in [Fv], [P], [Tv], [Av], [M], or [BULB] mode.

- [Tab Menus: Set-up](#)
- [Selecting Cards for Recording/Playback](#)
- [Folder Settings](#)
- [File Numbering](#)
- [File Naming](#)
- [Formatting](#)
- [Auto Rotate](#)
- [Adding Orientation Information to Movies](#)
- [Date/Time/Zone](#)
- [Language](#)
- [Video System](#)
- [Help](#)
- [Beeps](#)
- [Headphone Volume](#)
- [Power Saving](#)
- [Eco Mode](#)
- [Screen/Viewfinder Display](#)
- [Screen Brightness](#)
- [Viewfinder Brightness](#)
- [Screen and Viewfinder Color Tone](#)
- [Fine-Tuning Viewfinder Color Tone](#)
- [UI Magnification](#)
- [HDMI Resolution](#)
- [Touch Control](#)
- [Multi-Function Lock](#)
- [Shutter at Shutdown](#)
- [Sensor Cleaning](#)
- [Resetting the Camera](#) ☆
- [Custom Shooting Mode \(C1–C3\)](#) ☆
- [Battery Information](#)
- [Copyright Information](#) ☆
- [Other Information](#)

# Tab Menus: Set-up

---

## ● Set-up 1

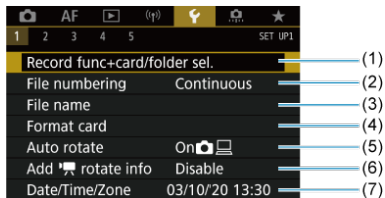

- (1) Record func+card/folder sel.
- [Selecting Cards for Recording/Playback](#)
  - [Creating a Folder](#)
- (2) [File numbering](#)
- (3) [File name](#)
- (4) [Format card](#)
- (5) [Auto rotate](#)
- (6) [Add \[Camera icon\] rotate info](#)
- (7) [Date/Time/Zone](#)

## ● Set-up 2



- (1) [Language](#)
- (2) [Video system](#)
- (3) [Help text size](#)
- (4) [Beep](#)
- (5) [Headphone volume](#)
- (6) [Power saving](#)
- (7) [Eco mode](#)

## ● Set-up 3



- (1) [Screen/viewfinder display](#)
- (2) [Screen brightness](#)
- (3) [Viewfinder brightness](#)
- (4) [Screen/viewfinder color tone](#)
- (5) [Fine-tune VF color tone](#)
- (6) [UI magnification](#)

## ● Set-up 4

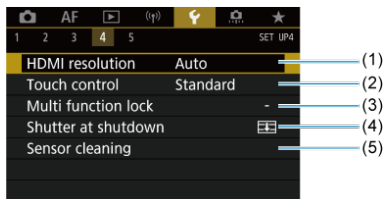

- (1) [HDMI resolution](#)
- (2) [Touch control](#)
- (3) [Multi function lock](#)
- (4) [Shutter at shutdown](#)
- (5) [Sensor cleaning](#)

## ● Set-up 5



- (1) [Reset camera](#) ☆
- (2) [Custom shooting mode \(C1-C3\)](#) ☆
- (3) [Battery info.](#)
- (4) [Copyright information](#) ☆
- (5) [Manual/software URL](#)
- (6) [Certification Logo Display](#) ☆
- (7) [Firmware](#) ☆

- In [**A**] and [**A**] mode, the following screen is displayed for [**5**].

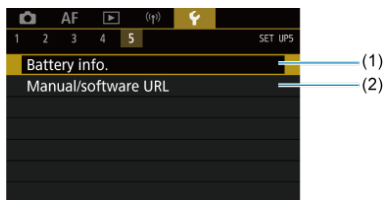

(1) [Battery info.](#)

(2) [Manual/software URL](#)



## Selecting Cards for Recording/Playback

---

[Recording Method with Two Cards Inserted](#)

[Recording/Playback Selection with Two Cards Inserted](#)

Recording is possible when card [1] or [2] is in the camera (except under some conditions). With only one card inserted, there is no need to follow these steps.

With two cards inserted, you can select the recording method and card to use for recording and playback as follows.

---

### Recording Method with Two Cards Inserted

---

1. Select [: Record func+card/folder sel.].

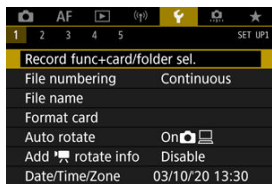

## 2. Set the recording method.

### ● separate

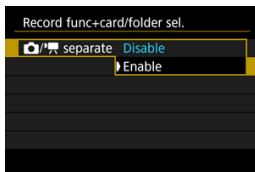

- Select **[Enable]** for automatic configuration of the recording method for still photos and movies. Movies are recorded to card **[1]** and still photos to card **[2]**.
- Movie recording is not possible if card **[1]** is full or not inserted.
- Without card **[2]** inserted, still photos can be captured but not saved. Still photo shooting is not possible if the card is full.

#### Caution

- Specifying **[Enable]** will make **[camera icon] Rec options**, **[movie icon] Rec options**, **[camera icon] Record/play**, and **[movie icon] Record/play** unavailable.

#### Note

- When set to **[Enable]**, card **[1]** is used for playback if the **< [play] >** button is pressed in movie recording mode. Card **[2]** is used for playback if the **< [play] >** button is pressed in still photo shooting mode.

## ● Rec options

Set the recording method for still photos.

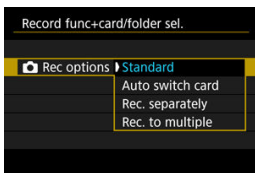



### • **Standard**

Records still photos to the card selected in [ **Record/play**].

### • **Auto switch card**



Same as [**Standard**], but shooting ends when the card becomes full. When you resume shooting, the camera switches to the other card automatically. At this time, a new folder is created.

### • **Rec. separately**



Enables you to set a specific image quality for each card (). For each shot, a still photo is recorded to card  and  in your specified image quality.

Note that recording separately to **RAW** and **CRAW** is not available for RAW images.

### • **Rec. to multiple**

For each shot, a still photo is recorded to card  and  in the same image quality.

### **Caution**

- Maximum burst for [**Rec. separately**] is lower if you specify different image sizes for cards  and  (.



## Note

### Rec. separately/Rec. to multiple

- Images are recorded with the same file number to card [1] and [2].
- The number of shots available as shown in the viewfinder and on the Quick Control screen is for the card with less free space.
- **[Card\* full]** is displayed when one of the cards becomes full, and shooting is no longer possible. To continue shooting, either replace the card or set [📷 **Rec options**] to **[Standard]** and select the card with free space.
- See [Folder Settings](#) for details on **[Folder]** in [🔧: **Record func +card/folder sel.**].

## ● Rec options

Set the recording method for movies.

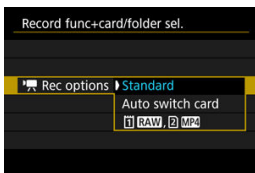



- **Standard**

Records movies to the card selected in [ **Record/play**].

- **Auto switch card**

Same as [**Standard**], but recording ends when the card becomes full. When you resume recording, the camera switches to the other card for recording. A new folder is created after switching cards.

- ** RAW,  MP4**

For each recording, a RAW movie is recorded to card  and an MP4 movie to card , both with the same file number. When one card becomes full, recording is no longer possible.

## Recording/Playback Selection with Two Cards Inserted

With [📷 Rec options]/[🎥 Rec options] set to [Standard] or [Auto switch card], select the card for recording and playback.

With [📷 Rec options] set to [Rec. separately] or [Rec. to multiple], or with [🎥 Rec options] set to [1 RAW, 2 MP4], select the card for playback.

### Setting size via the menu

#### ● Standard/Auto switch card

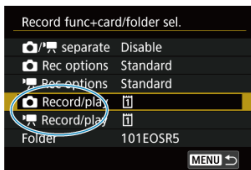

Select [Record/play].

- Select [📷 Record/play] for still photos or [🎥 Record/play] for movies.  
[1]: Use card 1 for recording and playback  
[2]: Use card 2 for recording and playback

#### ● Rec. separately/Rec. to multiple/1 RAW, 2 MP4

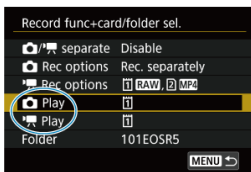

Select [Play].

- Select [📷 Play] for still photos or [🎥 Play] for movies.
- Pressing the <▶> button in still photo shooting mode plays images from the card selected in [📷 Play].
- Pressing the <▶> button in movie recording mode plays images from the card selected in [🎥 Play].



#### Note

- With [**Priority:** ] set, the camera switches to the priority card when cards are inserted or removed.

# Folder Settings

---

[Creating a Folder](#)

[Renaming Folders](#)

[Selecting a Folder](#)

You can freely create and select the folder where the captured images are to be saved. You can also rename folders.

---

## Creating a Folder

---

1. Select [: Record func+card/folder sel.].

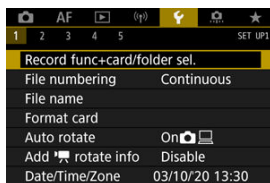

2. Select [Folder].

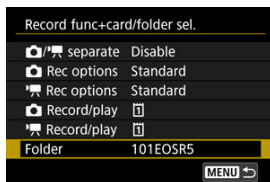



3. Select [Create folder].

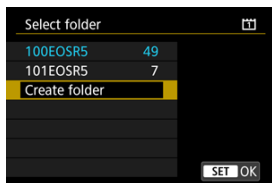

4. Select [OK].

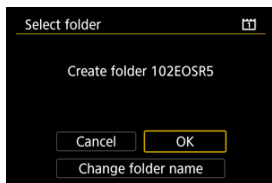

- To rename the folder, select [Change folder name].

### 1. Enter letters and numbers of your choice.

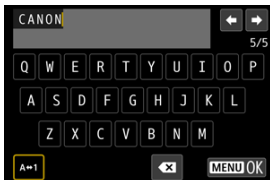

- You can enter five characters.
- By selecting [**A⇄1**], you can change the input mode.
- To delete single characters, select [**x**] or press the **< [trash] >** button.

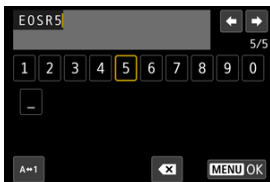

- Use the **< [dial] >** or **< [asterisk] >** to select a character, then press **< [SET] >** to enter it.

### 2. Exit the setting.

- Press the **< MENU >** button, then press [**OK**].

## Selecting a Folder

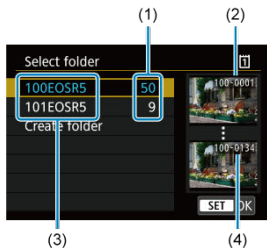

- (1) Number of images in folder
- (2) Lowest file number
- (3) Folder name
- (4) Highest file number

- Select a folder on the folder selection screen.
- Captured images are stored in your selected folder.

### Note

#### Folders

- Folders are named as in "100EOSR5," with a three-digit folder number followed by five letters or numbers. A folder can contain up to 9999 images (file number 0001–9999). When a folder becomes full, a new folder with the folder number increased by one is created automatically. Also, if manual reset (ⓧ) is executed, a new folder will be created automatically. Folders numbered from 100 to 999 can be created.

#### Creating folders with a computer

- With the card open on the screen, create a new folder with "DCIM" as the name. Open the DCIM folder and create as many folders as necessary to save and organize your images. "100ABC\_D" is the required format for folder names, and the first three digits must be a folder number in the range 100–999. The last five characters can be any combination of upper- and lower-case letters from A to Z, numerals, and the underscore "\_". The space cannot be used. Also note that two folder names cannot share the same three-digit folder number (for example, "100ABC\_D" and "100W\_XYZ") even if the remaining five characters in each name are different.

# File Numbering

---

[Continuous](#)

[Auto Reset](#)

[Manual Reset](#)

The captured images saved in a folder are assigned a file number from 0001 to 9999. You can change how the image files are numbered.

(Example)  
**IMG\_0001.JPG**  
|  
(1)  
(1) File number

---

## 1. Select [: File numbering].

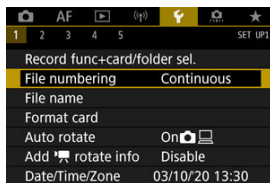

## 2. Set the item.

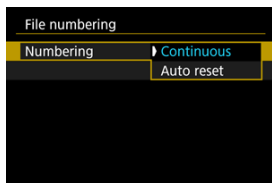

- Select [**Numbering**].
- Select [**Continuous**] or [**Auto reset**].

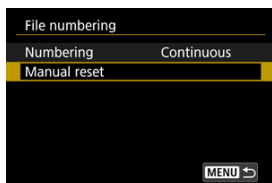

- If you want to reset the file numbering, select [**Manual reset**] (☑).

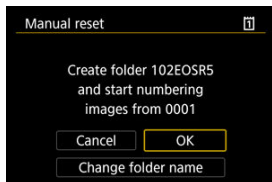

- Select [**OK**] to create a new folder, and the file number will start with 0001.

### ⚠ Caution

- If the file number in folder 999 reaches 9999, shooting will not be possible even if the card still has free space. After a message requesting you to replace the card is displayed, switch to a new card.

### For continuous file numbering regardless of switching cards or creating folders

File numbering is continuous up to 9999, even if you replace a card, create a folder, or switch the target card (as in ①→②). This is useful when you want to save images numbered anywhere between 0001 to 9999 on multiple cards or in multiple folders into one folder on a computer.

Note that file numbering may continue from any existing images in cards or folders that you switch to. If you want to use continuous file numbering, it is recommended that you use a newly formatted card each time.

#### File numbering after replacing cards or switching target cards

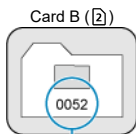
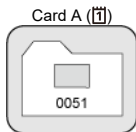

(1)

(1) Next sequential file number

#### File numbering after creating a folder

Card A



### For restarting file numbering from 0001 after switching cards or creating folders

File numbering is reset to 0001 if you replace a card, create a folder, or switch the target card (as in ①→②). This is useful if you want to organize images by cards or folders. Note that file numbering may continue from any existing images in cards or folders that you switch to. If you want to save images with the file numbering starting from 0001, use a newly formatted card each time.

#### File numbering after replacing cards or switching target cards

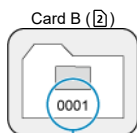
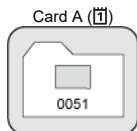

(1)

(1) File numbering is reset

#### File numbering after creating a folder

Card A



### **For resetting file numbering to 0001 or starting from 0001 in new folders**

When you reset the file numbering manually, a new folder is created automatically and the file numbering of images saved to that folder starts from 0001.

This is useful, for example, if you want to use different folders for the images taken yesterday and the ones taken today.



## File Naming

---

File names consist of four alphanumeric characters followed by a four-digit file number (🔗) and file extension. You can change the first four alphanumeric characters, which by default are unique for each camera and set when the camera is shipped.

User setting 1 enables you to register four characters of your choice. User setting 2 adds three initial, registered characters of your choice to a fourth character representing the image size that is added automatically after you shoot.

(Example)  
**IMG\_0001.JPG**

---

## Registering/Changing File Names

---

1. Select [🔗: File name].

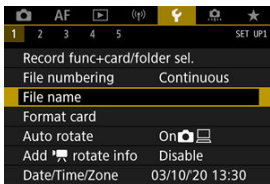

2. Select [Change User setting\*].

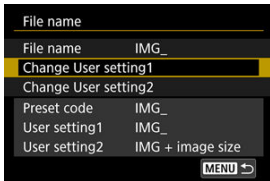

### 3. Enter letters and numbers of your choice.

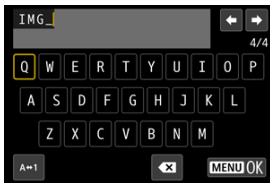

- Enter four characters for User setting 1 or three for User setting 2.
- By selecting [**A⇌1**], you can change the input mode.
- To delete single characters, select [**X**] or press the **< ̄ >** button.



- Use the **< 0 >** dial or **< \* >** to select a character, then press **< SET >** to enter it.

### 4. Exit the setting.

- Press the **< MENU >** button, then press [**OK**].

## 5. Select a registered file name.

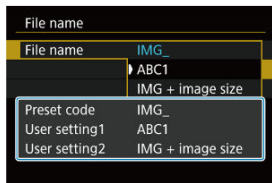

- Select [**File name**], then choose a registered file name.

### Caution

- An underscore (“\_”) cannot be used as the first character.

### Note

#### User setting 2

- Shooting after you have selected “\*\*\* + image size” (as registered to User setting 2) will add a character representing the current image size to your file name as the fourth character. Meanings of added characters are as follows.

“\*\*\*L”:  
L, L, RAW, or HEIF

“\*\*\*M”:  
M or M

“\*\*\*S”:  
S1 or S1

“\*\*\*T”:  
S2

“\*\*\*C”:  
CRAW

The automatically added fourth character enables you to determine image sizes without opening the files after transferring them to a computer. Based on file extensions, you can also distinguish RAW, JPEG, and HEIF images.

- Movies recorded with User setting 2 are named with the fourth character as an underscore.

# Formatting

If the card is new or was previously formatted (initialized) by another camera or computer, format the card with this camera.

## Caution

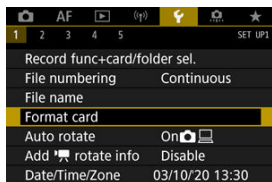

- **When the card is formatted, all images and data on the card will be erased. Even protected images will be erased, so make sure there is nothing you need to keep. If necessary, transfer the images and data to a computer, etc. before formatting the card.**

### 1. Select [: Format card].



### 2. Select a card.



- [] represents card 1, and [], card 2.
- Select the card.

### 3. Format the card.

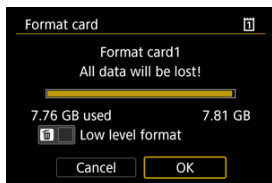

- Select **[OK]**.

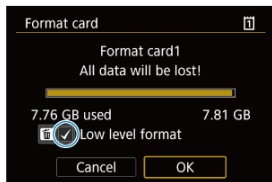

- For low-level formatting, press the  $\checkmark$  button to add a checkmark  $\checkmark$  to **[Low level format]**, then select **[OK]**.

## Conditions requiring card formatting

---

- The card is new.
- The card was formatted by a different camera or a computer.
- The card is full of images or data.
- A card-related error is displayed ()

### Low-level formatting

- Perform low-level formatting if the card's writing or reading speed seems slow or if you want to totally erase the data on the card.
- Since low-level formatting will format all recordable sectors on the card, the formatting will take longer than normal formatting.
- During low-level formatting, you can cancel formatting by selecting **[Cancel]**. Even in this case, normal formatting will already be complete and you can use the card as usual.

### Card file formats

- CFexpress cards are exFAT formatted.
- SD/SDHC cards will be formatted in FAT32. SDXC cards will be formatted in exFAT.
- Individual movies recorded to exFAT-formatted cards are recorded as a single file (without splitting them into multiple files) even if they exceed 4 GB, so the resulting movie file will exceed 4 GB.

#### Caution

- It may not be possible to use cards formatted with this camera in other cameras. Also note that exFAT-formatted cards may not be recognized by some computer operating systems or card readers.
- Formatting or erasing data on a card does not completely erase the data. Be aware of this when selling or discarding the card. When disposing of cards, take steps to protect personal information if necessary, as by physically destroying cards.

#### Note

- The card capacity displayed on the card format screen may be smaller than the capacity indicated on the card.
- This device incorporates exFAT technology licensed from Microsoft.

# Auto Rotate

---

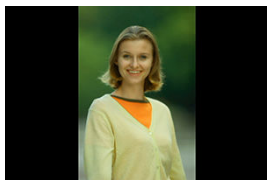

You can change the auto rotation setting that straightens images shot in vertical orientation when they are displayed.

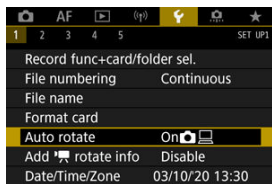

---

1. Select [: Auto rotate].

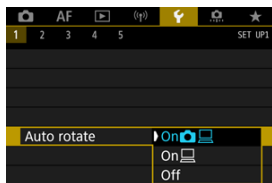

## 2. Select an option.



- **On**   
Automatically rotates images for display on both the camera and computers.
- **On**   
Automatically rotates images only for display on computers.
- **Off**  
Images are not automatically rotated.

### Caution

- Images captured with auto rotation set to **[Off]** will not rotate during playback even if you later set auto rotation to **[On]**.

### Note

- If a picture is taken while the camera is aimed up or down, automatic rotation to the proper orientation for viewing may not be performed correctly.
- If images are not rotated automatically on a computer, try using EOS software.



# Adding Orientation Information to Movies

---

For movies recorded with the camera held vertically, orientation information indicating which side is up can be added automatically to enable playback in the same orientation on smartphones or other devices.

---

## 1. Select [📷: Add 📷 rotate info].

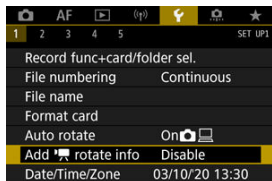

## 2. Select an option.

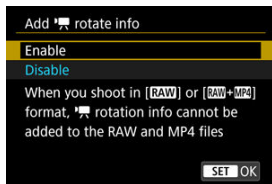

- **Enable**  
Play movies on smartphones or other devices in the orientation in which they were recorded.
- **Disable**  
Play movies horizontally on smartphones or other devices, regardless of the recording orientation.

 **Caution**

- [Add  rotate info] is not available for RAW or MP4 files when the movie recording format is **RAW** or **RAW+MP4**.
- Movies are played horizontally on the camera and via HDMI video output, regardless of this setting.

# Date/Time/Zone

---

When you turn on the power for the first time or if the date/time/zone have been reset, follow these steps to set the time zone first.

By setting the time zone first, you can simply adjust this setting as needed in the future and the date/time will be updated to match it.

Since the captured images will be appended with the shooting date and time information, be sure to set your date/time.

---

## 1. Select [: Date/Time/Zone].

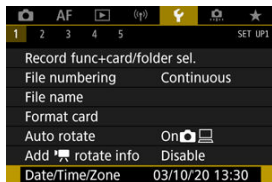

## 2. Set the time zone.

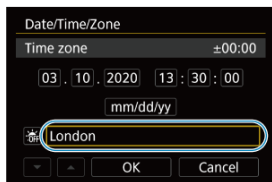

- Turn the < > dial to select [Time zone].

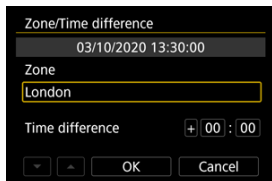

- Press < >.

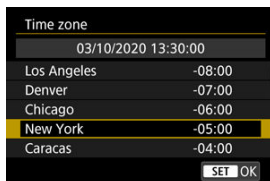

- Turn the < > dial to select the time zone, then press < >.
- If your time zone is not listed, press the < MENU > button, then set the difference from UTC in [Time difference].

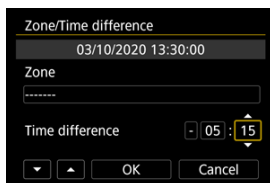

- Turn the < > dial to select a [Time difference] item (+/-/hour/minute), then press < >.
- Set by turning the < > dial, then press < >.
- After entering the time zone or time difference, turn the < > dial to select [OK], then press < >.



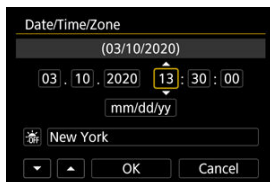



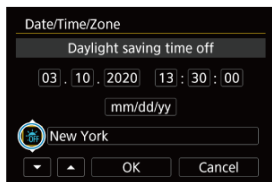

### 3. Set the date and time.



- Turn the < > dial to select an option, then press < >.
- Set by turning the < > dial, then press < >.

#### 4. Set daylight saving time.



- Set it as necessary.
- Turn the <  > dial to select [], then press <  >.
- Turn the <  > dial to select [], then press <  >.
- When the daylight saving time is set to [], the time set in step 3 will advance by 1 hour. If [] is set, the daylight saving time will be canceled and the time will go back by 1 hour.

#### 5. Exit the setting.

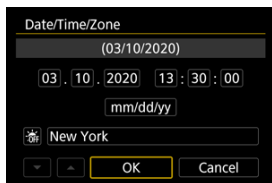

- Turn the <  > dial to select [OK].

#### Caution

- The date, time, and time zone settings may be reset when the camera is stored without the battery, when the battery is exhausted, or when it is exposed to freezing temperatures for an extended period. If this happens, set them once again.
- After changing [**Zone/Time difference**], check that the correct date/time are set.



#### Note

- Auto power off time may be extended while the [**⚙**: **Date/Time/Zone**] screen is displayed.

# Language

---

1. Select [: Language ].

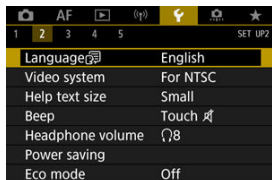

2. Set the desired language.



# Video System

---

Set the video system of any television used for display. This setting determines the frame rates available when you record movies.

---

## 1. Select [: Video system].



## 2. Select an option.

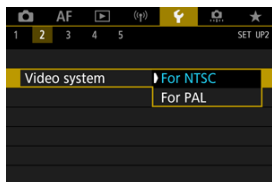

- **For NTSC**  
For areas where the TV system is NTSC (North America, Japan, South Korea, Mexico, etc.).
- **For PAL**  
For areas where the TV system is PAL (Europe, Russia, China, Australia, etc.).



# Help

## [Changing the Help Text Size](#)

When **[INFO Help]** is displayed, you can display a description of the feature by pressing the **<INFO>** button. Press it again to exit Help display. To scroll the screen when a scrollbar (1) appears on the right, turn the **<○>** dial.

---

### ● Example: [AF: Case 2]

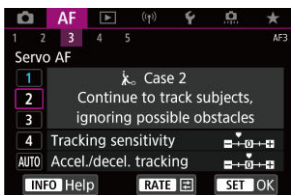

<INFO>

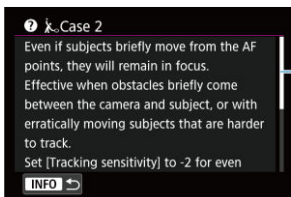

(1)

● Example: [?]: Multi function lock

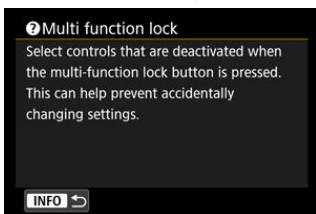
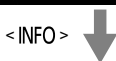
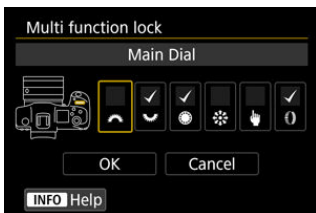

## Changing the Help Text Size

---

1. Select [: Help text size].

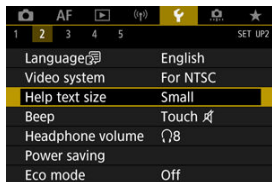

2. Select an option.

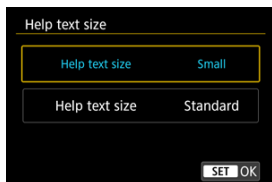

## 1. Select [🔊: Beep].

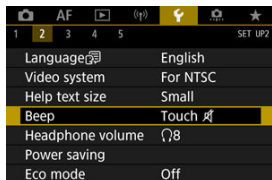

## 2. Select an option.

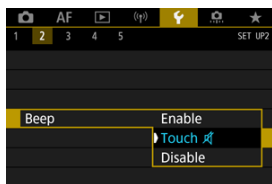

- **Enable**  
The camera beeps after focusing and in response to touch operations.
- **Touch 🔊**  
Disables beeping for touch operations.
- **Disable**  
Disables beeping for focus confirmation, self-timer shooting, and touch operations.

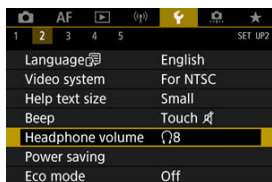

# Headphone Volume

1. Select [: Headphone volume].



2. Adjust the volume.



- Turn the < > dial to adjust the volume, then press < >.

## Note

- You can check sound from the built-in microphone or an external microphone on headphones when [: **Sound recording**] is set to an option other than [**Disable**] and [**High Frame Rate**] is set to [**Disable**].

# Power Saving

You can adjust the timing of when the screen, camera, and viewfinder turn off automatically after the camera is left idle (Display off, Auto power off, and Viewfinder off).

1. Select [**⚡**: Power saving].

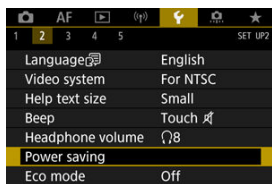

2. Select an option.

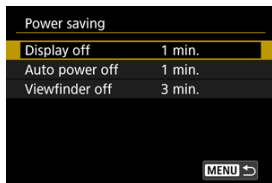

## Note

- Even when [**Auto power off**] is set to [**Disable**], the screen will turn off after the time set in [**Display off**].
- [**Display off**] and [**Auto power off**] settings have no effect when [**⚡: Eco mode**] is set to [**On**].

# Eco Mode

---

Enables you to conserve battery power in shooting mode. When the camera is not in use, the screen darkens to reduce battery consumption.

---

1. Select [: Eco mode].

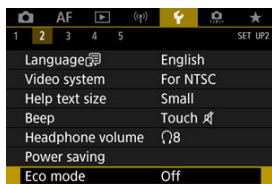

2. Select [On].

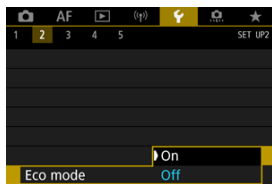

- The screen darkens when the camera is not used for approx. two seconds. Approx. ten seconds after darkening, the screen turns off.
- To activate the screen and prepare for shooting when the screen is off, press the shutter button halfway.

# Screen/Viewfinder Display

---

You can specify to use the screen or viewfinder for display, to avoid accidentally activating the eye sensor when the screen is open.



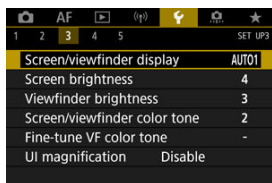

---

1. Select [: Screen/viewfinder display].

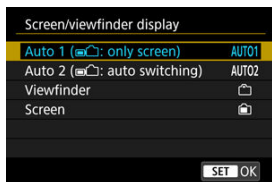

2. Select an option.



- **AUTO1: Auto 1 (: only screen)**  
Always use the screen for display when it is swung out.  
Use the screen for display when it is closed and facing you, and switch to viewfinder display when you look through the viewfinder.
- **AUTO2: Auto 2 (: auto switching)**  
Always use the screen for display, but switch to the viewfinder when you look through it.
- : **Viewfinder**  
Always use the viewfinder for display.
- : **Screen**  
Always use the screen for display when it is closed and facing you.





#### Note

- You can also switch between viewfinder and screen display by pressing a button you have customized by assigning to switching. With this setting set to **[AUTO1]** or **[AUTO2]**, the camera responds to the eye sensor accordingly.
- With **[AUTO1]** set, the camera responds to the eye sensor when the screen is closed and facing you but does not respond when it is swung out.

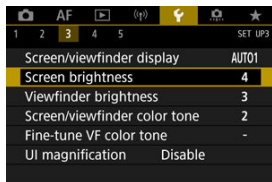

# Screen Brightness

1. Select [: Screen brightness].

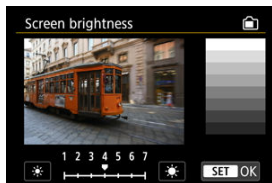

2. Make the adjustment.



- Referring to the gray image, turn the < > dial to adjust brightness, then press < >. Check the effect on the screen.

## Note

- To check the image's exposure, referring to the histogram is recommended ().

# Viewfinder Brightness

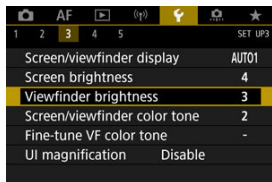

---

1. Select [: Viewfinder brightness].



2. Make the adjustment.



- Referring to the gray image, turn the < > dial to adjust brightness, then press < >. Check the effect in the viewfinder.

## Screen and Viewfinder Color Tone

---

1. Select [: Screen/viewfinder color tone].

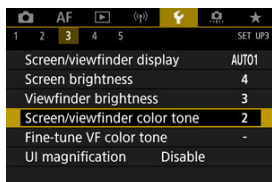

2. Make the adjustment.

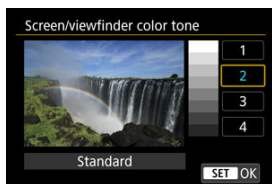

- Turn the < > dial to select an option, then press < >.

# Fine-Tuning Viewfinder Color Tone

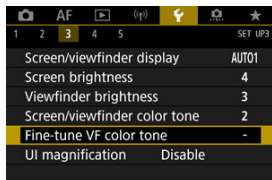

---

1. Select [: Fine-tune VF color tone].

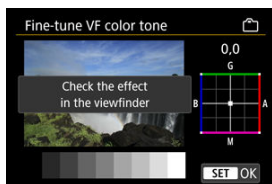

2. Make the adjustment.



- Referring to the gray image, use < > for adjustment, then press < >. Check the effect in the viewfinder.

# UI Magnification

---

You can magnify menu screens by double-tapping with two fingers. Double-tap again to restore the original display size.

---

1. Select [: UI magnification].

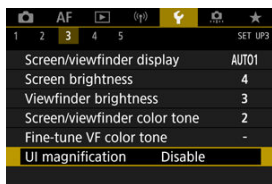

2. Select [Enable].

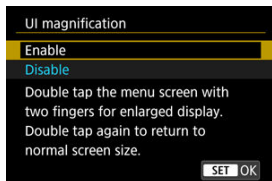

## Caution

- Use camera controls when configuring menu functions with the display magnified. Touch-screen operations are not supported.

# HDMI Resolution

---

Set the image output resolution used when the camera is connected to a television or external recording device with an HDMI cable.

---

1. Select [: HDMI resolution].

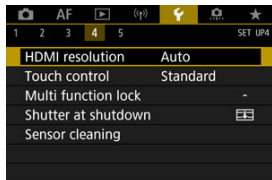

2. Select an option.



- **Auto**  
The images will automatically be displayed at the optimum resolution matching the connected television.
- **1080p**  
Output at 1080p resolution. Select if you prefer to avoid display or delay issues when the camera switches resolution.

# Touch Control

1. Select [**Touch control**].

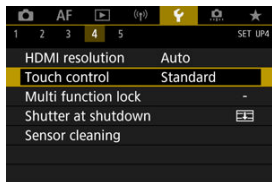

2. Select an option.

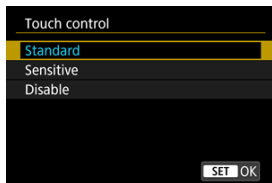

- [**Sensitive**] makes the touch-screen panel more responsive than [**Standard**].
- To disable touch operations, select [**Disable**].

## Caution

### Precautions for touch-screen panel operations

- Do not use sharp objects such as fingernails or ballpoint pens for touch operations.
- Do not use wet fingers for touch operations. If the screen has any moisture or if your fingers are wet, the touch-screen panel may not respond or malfunction may occur. In this case, turn off the power and wipe off the moisture with a cloth.
- Attaching a commercially available protective sheet or a sticker on the screen may impair responsiveness to touch operations.
- The camera may not respond as well if you quickly perform touch operation when [**Sensitive**] is set.



# Multi-Function Lock

Specify camera controls to lock when the Multi-function lock is enabled. This can help prevent accidentally changing settings.

1. Select [: Multi function lock].

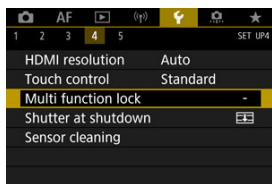

2. Select camera controls to lock.

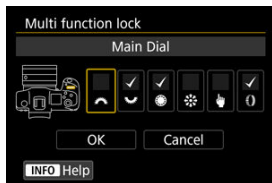

- Press <  > to add a checkmark [✓].
- Select [**OK**].
- Pressing the < **LOCK** > button locks the selected [✓] camera controls.

## Note

- An asterisk "\*" to the right of [: Multi function lock] indicates that the default setting has been modified.

## Shutter at Shutdown

---

You can set whether to leave the shutter open or close it when the camera's power switch is set to <OFF>.

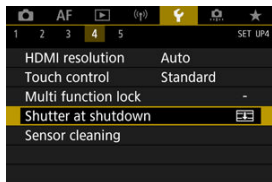

---

1. Select [: Shutter at shutdown].

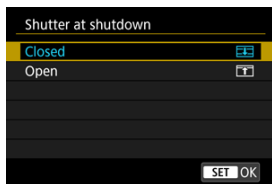

2. Select an option.



- : **Closed**  
Closes the shutter. Normally set to closed, to prevent dust from adhering to the sensor when you switch lenses.
- : **Open**  
Leaves the shutter open. This keeps camera quieter when the power switch is set to <ON> or <OFF>. Useful when you want to shoot quietly.

### Note

- Regardless of the setting, the shutter remains as it is when auto power off is activated.

# Sensor Cleaning

---

[Cleaning Now](#)

[Cleaning Automatically](#)

[Cleaning Manually](#) ☆

The camera's sensor cleaning feature cleans the front of the image sensor.

## Note

- For best results, clean with the camera in a stable position on a desk or other flat surface.

---

## Cleaning Now

---

1. Select [: Sensor cleaning].

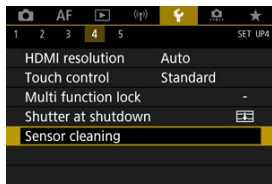

2. Select [Clean now. ].

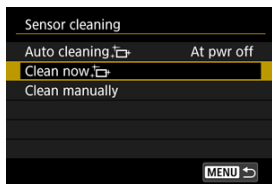

- Select [OK] on the confirmation screen.

 **Note**

- Even if you repeat the sensor cleaning, the result will not improve much. Note that [Clean now. ] may not be available immediately after cleaning.

## Cleaning Automatically

1. Select [Auto cleaning. ].

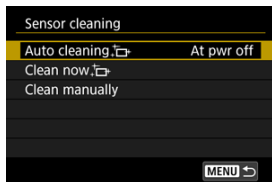

2. Select an option.

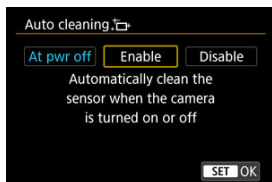

- Turn the <  > dial to select an option, then press <  >.

Dust that could not be removed by automatic cleaning can be removed manually with a commercially available blower or similar tool.

Always use a fully charged battery.

The image sensor is extremely delicate. If the sensor needs to be cleaned directly, having it done by a Canon Service Center is recommended.

### 1. Select [Clean manually].

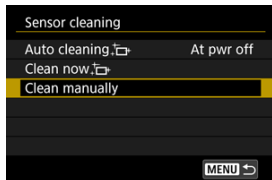

### 2. Select [OK].

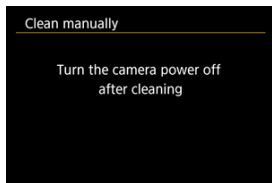
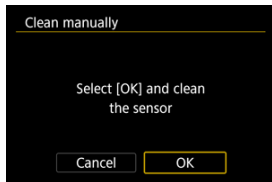

### 3. Remove the lens and clean the sensor.

## 4. End the cleaning.

- Set the power switch to < OFF >.



### Note

- Using the household power outlet accessories (sold separately) is recommended.



### Caution

- **While cleaning the sensor, never do any of the following. If the power is cut off, the shutter will close. These may result in damaging the image sensor and shutter curtains.**
  - **Setting the power switch to < OFF >.**
  - **Removing or inserting the battery.**
- The surface of the image sensor is extremely delicate. Clean the sensor with care.
- Use a plain blower without any brush attached. A brush can scratch the sensor.
- Do not insert the blower tip inside the camera beyond the lens mount. If the power is turned off, the shutter will close and the shutter curtains may get damaged.
- Never use pressurized air or gas to clean the sensor. Pressurized air may damage the sensor, and sprayed gas may freeze on the sensor and scratch it.
- If the battery level becomes low while cleaning the sensor, the beeper will sound as a warning. Stop cleaning the sensor.
- If a smudge that cannot be removed with a blower remains, having the sensor cleaned by a Canon Service Center is recommended.

The camera's settings for shooting functions and menu functions can be restored to their defaults.

---

1. Select [: Reset camera].

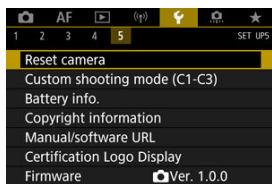

2. Select an option.

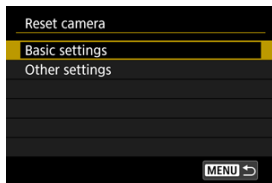

- **Basic settings**  
Restores default settings for camera shooting functions and menu settings.
  - **Other settings**  
Settings for individual selected items can be reset.
3. Clear the settings.
    - Select [**OK**] on the confirmation screen.





#### Note

- Still photo Custom shooting modes are reset when [**Custom shooting mode (C1-C3)**] in [**Other settings**] is selected in still photo shooting mode, and movie Custom shooting modes are reset when this option is selected in movie recording mode.

[Automatic Update of Registered Settings](#)

[Canceling Registered Custom Shooting Modes](#)

Current camera settings such as shooting, menu, and Custom Function settings can be registered in Custom shooting modes [C1<sub>p</sub>] to [C3<sub>p</sub>]. You can register different functions to use when shooting still photos or movies.

---

1. Select [**☛**: Custom shooting mode (C1-C3)].

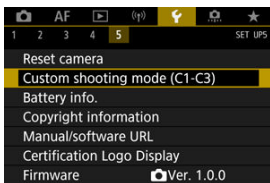

2. Select [**Register settings**].

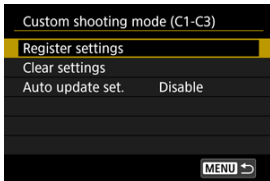

### 3. Register the desired items.

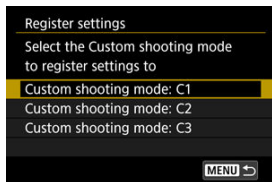

- Select the Custom shooting mode to register, then select **[OK]** on the **[Register settings]** screen.
- The current camera settings are registered to Custom shooting mode C\*.

## Automatic Update of Registered Settings

---

If you change a setting while shooting in Custom shooting mode, the mode can be automatically updated with the new setting (Auto update). To enable this automatic update, set **[Auto update set.]** to **[Enable]** in step 2.

## Canceling Registered Custom Shooting Modes

---

If you select **[Clear settings]** in step 2, the settings of each mode can be restored to default settings, as they were before registration.



### Note

- You can also change shooting and menu settings in Custom shooting modes.

# Battery Information

- ☑ [Registering Batteries to the Camera](#)
- ☑ [Labeling Batteries with Serial Numbers](#)
- ☑ [Checking the Remaining Capacity of a Registered Battery Not in Use](#)
- ☑ [Deleting the Registered Battery Information](#)

You can check the conditions of the battery you are using. By registering multiple batteries to the camera, you can check their approximate remaining capacity and usage history.

## 1. Select [🔋: Battery info.].

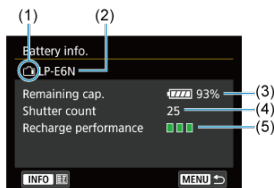
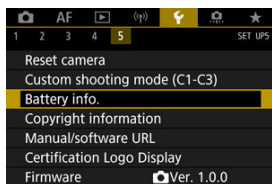

- (1) Battery position
- (2) Model of battery or household power source used.
- (3) Battery level indicator (🔋) with the remaining battery level, in 1% increments.
- (4) The number of shots taken with the current battery. The number is reset when the battery is charged.
- (5) State of battery recharge performance, in three levels.
  - ■ ■ (Green): Battery recharge performance is good.
  - ■ □ (Green): Battery recharge performance is slightly degraded.
  - □ □ (Red): Purchasing a new battery is recommended.

 **Caution**

- Using a genuine Canon Battery Pack LP-E6NH/LP-E6N is recommended. If you use batteries that are not genuine Canon products, the camera's full performance may not be attained or malfunction may result.

 **Note**

- The shutter count is the number of still photos taken (not including movie recording).
- Battery information is also displayed when an optional Battery Grip BG-R10 is used.
- If a battery communication error message is displayed, follow the instructions in the message.

## Registering Batteries to the Camera

You can register up to six LP-E6NH/LP-E6N/LP-E6 battery packs to the camera. To register multiple batteries to the camera, follow the procedure below for each battery.

### 1. Press the <INFO> button.

- With the battery info. screen displayed, press the <INFO> button.
- If the battery is not registered, it will be grayed out.

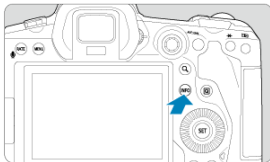

### 2. Select [Register].

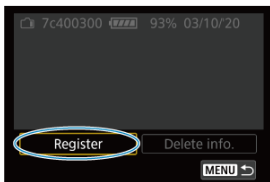

### 3. Select [OK].

- The battery is now displayed in white.

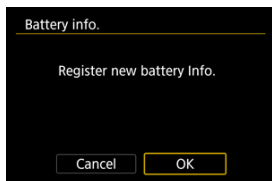

#### Note

- The battery cannot be registered if the household power outlet accessories (sold separately, ) are used.



## Labeling Batteries with Serial Numbers

It is convenient to label registered LP-E6NH/LP-E6N/LP-E6 battery packs with their serial numbers, using commercially available labels.

1. On a label approx. 25×15 mm, write the serial number (1).

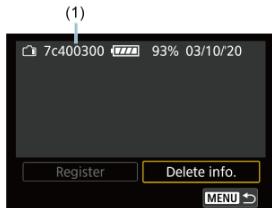

2. Apply the label.

- Set the power switch to < OFF >.
- Remove the battery from the camera.
- Apply the label as shown in the illustration (on the side with no electrical contacts).

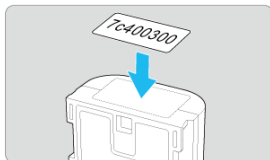

 **Caution**

- Do not apply the label on any part other than as shown in the illustration in step 2. Otherwise, the misplaced label may make it difficult to insert the battery or impossible to turn on the power.
- When you use Battery Grip BG-R10 (sold separately), the label may peel off after repeated insertion and removal from the battery magazine. If it peels off, apply a new label.

## Checking the Remaining Capacity of a Registered Battery Not in Use

You can check the remaining capacity of batteries not currently in use, as well as their last date of use.

### 1. Find the matching serial number.

- On the battery history screen, find the battery serial number (1) matching the serial number that the battery is labeled with.
- You can check the respective battery's approximate remaining capacity (2) and the date when it was last used (3).

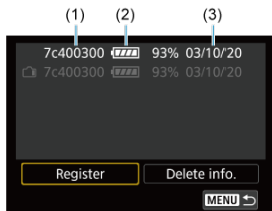

## Deleting the Registered Battery Information

---

**1. Select [Delete info.].**

- In [Registering Batteries to the Camera](#), select **[Delete info.]** in step 2.

**2. Select the battery information to delete.**

- [✓] is displayed.

**3. Press the <  > button.**

- Select **[OK]** on the confirmation screen.

[☑ Checking the Copyright Information](#)

[☑ Deleting the Copyright Information](#)

When you set the copyright information, it will be recorded to the image as Exif information.

## ⚠ Caution

- If the entry for "Author" or "Copyright" is long, it may not be displayed entirely when you select **[Display copyright info.]**.

## 📱 Note

- You can also set or check copyright information with EOS Utility (EOS software, [📄](#)).

## 1. Select [**🔑**: Copyright information].

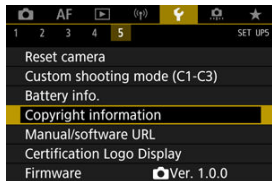





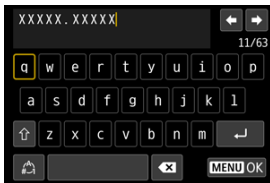

## 2. Select an option.



### 3. Enter text.



- Use the <  > dial or <  > to select a character, then press <  > to enter it.
- By selecting [  ], you can change the input mode.
- To delete single characters, select [  ] or press the <  > button.

### 4. Exit the setting.

- Press the < **MENU** > button, then press [ **OK** ].

## Checking the Copyright Information

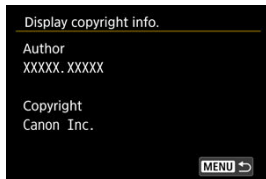

When you select [ **Display copyright info.** ] in step 2, you can check the [ **Author** ] and [ **Copyright** ] information that you entered.

## Deleting the Copyright Information

---

When you select [**Delete copyright information**] in step 2, you can delete the [**Author**] and [**Copyright**] information.

## Other Information

---

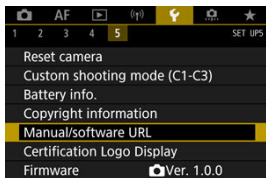

- **Manual/software URL**

To download instruction manuals, select [**⚡**: **Manual/software URL**] and scan the displayed QR code with a smartphone. You can also use a computer to access the website at the URL displayed and download software.

- **Certification Logo Display** ☆

Select [**⚡**: **Certification Logo Display**] to display some of the logos of the camera's certifications. Other certification logos can be found on the camera body and packaging.

- **Firmware** ☆

Select [**⚡**: **Firmware**] to update the firmware of the camera, lens, or other compatible accessories in use.



## Custom Functions/My Menu

---

You can fine-tune camera functions and change the functionality of buttons and dials to suit your shooting preferences. You can also add menu items and Custom Functions that you adjust frequently to My Menu tabs.

- [Tab Menus: Customization](#)
- [Custom Function Setting Items](#)
- [Tab Menus: My Menu](#)
- [Registering My Menu](#)

## Tab Menus: Customization

### ● Custom Functions 1

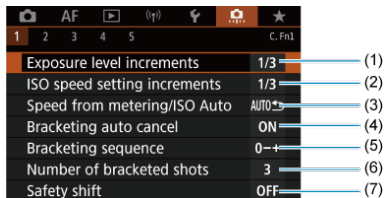

- (1) [Exposure level increments](#)
- (2) [ISO speed setting increments](#)
- (3) [Speed from metering/ISO Auto](#)
- (4) [Bracketing auto cancel](#)
- (5) [Bracketing sequence](#)
- (6) [Number of bracketed shots](#)
- (7) [Safety shift](#)

### ● Custom Functions 2



- (1) [Same expo. for new aperture](#)
- (2) [AE lock meter. mode after focus](#)
- (3) [Restrict shooting modes](#)
- (4) [Set shutter speed range](#)
- (5) [Set aperture range](#)

### ● Custom Functions 3

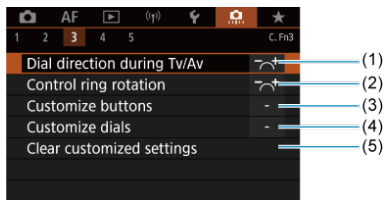

- (1) [Dial direction during Tv/Av](#)
- (2) [Control ring rotation](#)
- (3) [Customize buttons](#)
- (4) [Customize dials](#)
- (5) [Clear customized settings](#)

### ● Custom Functions 4

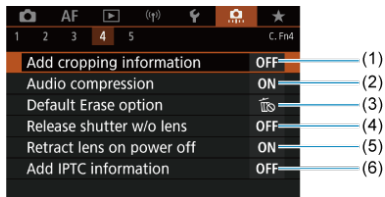

- (1) [Add cropping information](#)
- (2) [Audio compression](#)
- (3) [Default Erase option](#)
- (4) [Release shutter w/o lens](#)
- (5) [Retract lens on power off](#)
- (6) [Add IPTC information](#)

## ● Custom Functions 5



(1) [Clear all Custom Func. \(C.Fn\)](#)

Selecting [**Clear all Custom Func. (C.Fn)**] clears all Custom Function settings.

## Custom Function Setting Items

---

[C.Fn1](#)

[C.Fn2](#)

[C.Fn3](#)

[C.Fn4](#)

[C.Fn5](#)

You can customize camera features on the [] tab to suit your shooting preferences. Any settings you change from default values are displayed in blue.

---

### Exposure level increments

You can specify to use 1/2-stop increments as the increments for shutter speed, aperture value, exposure compensation, AEB, flash exposure compensation, and FEB.

- 1/3: 1/3-stop
- 1/2: 1/2-stop

#### Note

- Display when set to [1/2-stop] is as follows.



### ISO speed setting increments

You can change the manual ISO speed setting increment to a whole stop.

- 1/3: 1/3-stop
- 1/1: 1-stop

#### Note

- Even if [1-stop] is set, ISO speed will be automatically set in 1/3-stop increments when ISO Auto is set.

## Speed from metering/ISO Auto

You can set the ISO speed status after the metering timer ends in cases where, for ISO Auto operation in [P]/[Tv]/[Av]/[M]/[B] mode, the camera has adjusted the ISO speed during metering or during the metering timer.

- AUTO↶: Restore Auto after metering
- AUTO↷: Retain speed after metering

## Bracketing auto cancel

You can specify to cancel AEB and white balance bracketing when the power switch is set to <OFF>.

- ON: Enable
- OFF: Disable

## Bracketing sequence

The AEB shooting sequence and white balance bracketing sequence can be changed.

- 0→: 0, -, +
- -0+: -, 0, +
- +0-: +, 0, -

AEB	White Balance Bracketing	
	B/A Direction	M/G Direction
0: Standard exposure	0: Standard white balance	0: Standard white balance
-: Underexposure	-: Blue bias	-: Magenta bias
+: Overexposure	+: Amber bias	+: Green bias

## Number of bracketed shots

The number of shots taken with AEB and white balance bracketing can be changed. When **[Bracketing sequence]** is set to **[0, -, +]**, the bracketed shots will be taken as shown in the following table.

- **3: 3 shots**
- **2: 2 shots**
- **5: 5 shots**
- **7: 7 shots**

(1-stop/step increments)

	1st Shot	2nd Shot	3rd Shot	4th Shot	5th Shot	6th Shot	7th Shot
3: 3 shots	Standard (0)	-1	+1				
2: 2 shots	Standard (0)	±1					
5: 5 shots	Standard (0)	-2	-1	+1	+2		
7: 7 shots	Standard (0)	-3	-2	-1	+1	+2	+3



### Note

- If **[2 shots]** is set, you can select the + or - side when setting the AEB range. With white balance bracketing, the second shot is adjusted toward the negative side for the B/A or M/G direction.





## Safety shift

If the subject brightness changes and the standard exposure cannot be obtained within the autoexposure range, the camera will automatically change the manually selected setting to obtain the standard exposure. **[Shutter speed/Aperture]** applies to **[Tv]** or **[Av]** mode. **[ISO speed]** applies to **[P]**, **[Tv]**, or **[Av]** mode.

- **OFF: Disable**
- **Tv/Av: Shutter speed/Aperture**
- **ISO: ISO speed**

### Note

- Safety shift overrides any changes to **[ISO speed range]** or **[Min. shutter spd.]** from default settings in :  **ISO speed settings** if standard exposure cannot be obtained.
- The minimum and maximum limits for the safety shift with the ISO speed are determined by **[Auto range]** . However, if the manually set ISO speed exceeds the **[Auto range]**, the safety shift will take effect up or down to the manually set ISO speed.
- Safety shift will take effect as necessary even when flash is used.

### Same expo. for new aperture

The maximum aperture value may decrease (the lowest f/number may increase) in **[M]** mode (manual exposure shooting) with ISO speed set manually (except when set to ISO Auto) if you (1) Change lenses, (2) Attach an extender, or (3) Use a zoom lens with a variable maximum aperture value. This function prevents the corresponding underexposure by adjusting ISO speed or shutter speed (Tv value) automatically to maintain the same exposure as before (1), (2), or (3).

With **[ISO speed/Shutter speed]**, the ISO speed is automatically adjusted within the ISO speed range. If exposure cannot be maintained by adjusting ISO speed, shutter speed (Tv value) is automatically adjusted.

- **OFF: Disable**
- **ISO: ISO speed**
- **ISO/Tv: ISO speed/Shutter speed**
- **Tv: Shutter speed**

#### Caution

- Does not respond to changes in effective aperture value from changes in magnification when macro lenses are used.
- Cannot provide the same exposure as before (1), (2), or (3) if **[ISO speed]** is set and the exposure cannot be maintained at speeds set in **[ISO speed range]**.
- Cannot provide the same exposure as before (1), (2), or (3) if **[Shutter speed]** is set and the exposure cannot be maintained at speeds set in **[: Set shutter speed range]**.

#### Note

- Also responds to changes in the highest f/number (minimum aperture).
- The original exposure setting is restored if you perform (1), (2), or (3) with **[ISO speed]**, **[ISO speed/Shutter speed]**, or **[Shutter speed]** set and do not adjust ISO speed, shutter speed, or aperture value before returning the camera to the original state, before (1), (2), or (3).
- Shutter speed may change to maintain exposure if the ISO speed increases to an expanded ISO speed when **[ISO speed]** is set.

## AE lock meter. mode after focus

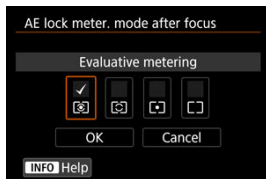

For each metering mode, you can specify whether to lock the exposure (AE lock) once subjects are in focus with One-Shot AF. The exposure will be locked while you keep pressing the shutter button halfway. Select metering modes for AE lock and add a checkmark [✓]. Select [OK] to register the setting.

## Restrict shooting modes

1. Select [: Restrict shooting modes].

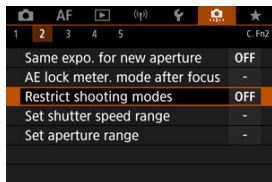

2. Select [Enable].

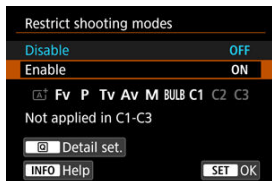

3. Press the < > button.

#### 4. Select a shooting mode.

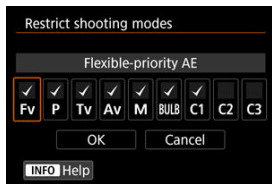

- Turn the  $\langle \text{DIAL} \rangle$  dial to select shooting modes, then press  $\langle \text{SET} \rangle$  to add a checkmark [✓].

#### ! Caution

- Restricted shooting mode settings are not registered to [C1P], [C2P], or [C3P].
- [A+] is not available with [RESTR]: **Restrict shooting modes** set to [Enable].
- The [✓] mark cannot be cleared from all nine modes at the same time.

#### Set shutter speed range

You can set the shutter speed range. In [Fv], [Tv], or [M] mode, you can set the shutter speed manually within your specified range. In [P] and [Av] mode, or in [Fv] mode with shutter speed set to [AUTO], the shutter speed is set automatically within your specified range (except for movie recording). Select [OK] to register the setting.

- **Lowest speed**  
Can be set in a range of 30 sec.–1/4000 sec.
- **Highest speed**  
Can be set in a range of 1/8000 sec.–15 sec.

#### Set aperture range

You can set the aperture value range. In [Fv], [Av], [M], or [BULB] mode, you can set the aperture value manually within your specified range. In [P] and [Tv] mode, or in [Fv] mode with the aperture value set to [AUTO], the aperture value is set automatically within your specified range. Select [OK] to register the setting.

- **Max. aperture**  
Can be set in a range of f/1.0–f/64.

- **Min. aperture**

Can be set in a range of  $f/91$ – $f/1.4$ .





**Note**

- The available aperture value range varies depending on the lens's minimum and maximum aperture value.



### Dial direction during Tv/Av

Dial turning direction when setting the shutter speed and aperture value can be reversed. Reverses the turning direction of the < 

- : Normal
- : Reverse direction

### Control ring rotation

RF lens and mount adapter control ring turning direction when setting the shutter speed and aperture value can be reversed.

- : Normal
- : Reverse direction

### Customize buttons

You can assign frequently used functions to camera buttons that are easy for you to use. Different functions, for use when shooting still photos or movies, can be assigned to the same button.

1. Select [: Customize buttons].

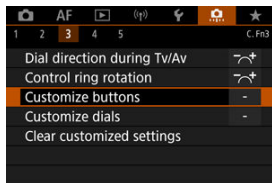



## 2. Select a part of the bar.





## 3. Select a function to assign.



- Press <  > to set it.
- You can configure advanced settings for functions labeled with **[INFO]** in the lower left of the screen by pressing the <  > button.

### Note

- [: **Customize buttons**] settings are not cleared even if you select [: **Clear all Custom Func. (C.Fn)**]. To clear the settings, select [: **Clear customized settings**].



## Functions available for customization

### AF

●: Default ○: Available for customization

Function			MODE	AF-ON				LENS	M.Fn		SET	
AF Metering and AF start	●			●	○	○	○	○				
AF-OFF AF stop		○	○	○	○	○	○	●	○	○		
AF point selection		○	○	○	○	●	○	○	○	○	○	
Direct AF point selection												○
Set AF point to center		○	○	○	○	○	○	○	○	○	●	
AF↔ Switch to registered AF func. <sup>*1</sup>				○	○	○	○	○				
Direct AF method selection <sup>*1</sup>		○	○	○	○	○	○	○	○	○	○	
One-Shot AF Servo AF <sup>*1</sup>		○	○	○	○	○	○	○	○	○	○	
Eye Detection AF <sup>*1</sup>				○	○	○	○	○				
Touch & drag AF		○	○	○	○	○	○	○	○	○	○	
Eye detection		○	○	○	○	○	○	○	○	○	○	
PEAK Peaking		○	○	○	○	○	○	○	○	○	○	





















 Focus guide		<input type="radio"/>	<input type="radio"/>	<input type="radio"/>	<input type="radio"/>	<input type="radio"/>	<input type="radio"/>	<input type="radio"/>	<input type="radio"/>	<input type="radio"/>	<input type="radio"/>	
 Drive mode*1		<input type="radio"/>	<input type="radio"/>	<input type="radio"/>	<input type="radio"/>	<input type="radio"/>	<input type="radio"/>	<input type="radio"/>	<input type="radio"/>	<input type="radio"/>	<input type="radio"/>	

\* 1: Cannot be assigned as a function available in movie recording.

## Exposure Compensation

●: Default ○: Available for customization

Function												
*AF-OFF AE lock, AF stop		<input type="radio"/>	<input type="radio"/>	<input type="radio"/>	<input type="radio"/>	<input type="radio"/>	<input type="radio"/>	<input type="radio"/>	<input type="radio"/>	<input type="radio"/>		
 Metering start	<input type="radio"/>											
* AE lock		<input type="radio"/>	<input type="radio"/>	<input type="radio"/>	●*3	<input type="radio"/>	<input type="radio"/>	<input type="radio"/>	<input type="radio"/>	<input type="radio"/>		
*H AE lock (hold)		<input type="radio"/>	<input type="radio"/>	<input type="radio"/>	<input type="radio"/>	<input type="radio"/>	<input type="radio"/>	<input type="radio"/>	<input type="radio"/>	<input type="radio"/>		
* AE lock (while button pressed)*1	<input type="radio"/>											
 AE lock/FE lock*1		<input type="radio"/>	<input type="radio"/>	<input type="radio"/>	●*4	<input type="radio"/>	<input type="radio"/>	<input type="radio"/>	<input type="radio"/>	<input type="radio"/>		
 Expo comp (hold btn, turn  )				<input type="radio"/>	<input type="radio"/>	<input type="radio"/>	<input type="radio"/>	<input type="radio"/>			<input type="radio"/>	
 Set ISO speed(hold btn, turn  )				<input type="radio"/>	<input type="radio"/>	<input type="radio"/>	<input type="radio"/>	<input type="radio"/>			<input type="radio"/>	
<b>FEL</b> FE lock*1		<input type="radio"/>	<input type="radio"/>	<input type="radio"/>	<input type="radio"/>	<input type="radio"/>	<input type="radio"/>	<input type="radio"/>	<input type="radio"/>	<input type="radio"/>		





















\* 1: Cannot be assigned as a function available in movie recording.

\* 3: Default in movie recording.

\* 4: Default in still photo shooting.

## Image

●: Default ○: Available for customization

Function												
 Image quality <sup>*1</sup>		○	○	○	○	○	○	○	○	○	○	
 One-touch image quality setting <sup>*1</sup>		○	○	○	○	○	○	○	○	○	○	
 One-touch image quality (hold) <sup>*1</sup>		○	○	○	○	○	○	○	○	○	○	
 Still img aspect ratio		○	○	○	○	○	○	○	○	○	○	
 Auto Lighting Optimizer		○	○	○	○	○	○	○	○	○	○	
 Picture Style		○	○	○	○	○	○	○	○	○	○	
 Protect		○	○	○	○	○	○	○	○	○		
 Rating		○	○	○	○	○	○	○	○	○		
 Record func +card/folder sel.		○	○	○	○	○	○	○	○	○	○	

\* 1: Cannot be assigned as a function available in movie recording.

## Movies

●: Default ○: Available for customization











Function			MODE	AF-ON				LENS	M.Fn		SET	
 Zebra pattern*2			○	○	○	○	○	○	○	○	○	
 Movie recording		●	○	○	○		○	○	○	○		
 Pause Movie Servo AF			○	○	○	○	○	○	○	○	○	



\* 2: Cannot be assigned as a function available in still photo shooting.

## Operation

●: Default ○: Available for customization

Function			MODE	AF-ON				LENS	M.Fn		SET	
 Flash function settings*1		○	○	○	○	○	○	○	○	○	○	
 Dial function settings		○	○	○	○	○	○	○	●	○	○	
 Short press: LCD illumination Long press: LCD info switching										○		
 Short press: LCD info switching Long press: LCD illumination										●		
 LCD panel illumination		○	○	○	○	○	○	○	○	○		
 LCD panel info switching		○	○	○	○	○	○	○	○	○		
<b>MODE</b> Shooting mode settings		○	●	○	○	○	○	○	○	○		

<b>C</b> Switch to Custom shooting mode									<input type="checkbox"/>			
 Still $\longleftrightarrow$ movie switching									<input type="checkbox"/>			
 Depth-of-field preview <sup>1</sup>		<input type="checkbox"/>	<input type="checkbox"/>	<input type="checkbox"/>	<input type="checkbox"/>	<input type="checkbox"/>	<input checked="" type="checkbox"/> *4	<input type="checkbox"/>	<input type="checkbox"/>	<input type="checkbox"/>	<input type="checkbox"/>	
<b>AUTO</b> Reset selected item in Fv mode <sup>1</sup>		<input type="checkbox"/>	<input type="checkbox"/>	<input type="checkbox"/>	<input type="checkbox"/>	<input type="checkbox"/>	<input type="checkbox"/>	<input type="checkbox"/>	<input type="checkbox"/>	<input type="checkbox"/>	<input type="checkbox"/>	
<u>All Auto</u> Reset Tv/Av/ <input checked="" type="checkbox"/> /ISO in Fv mode <sup>1</sup>		<input type="checkbox"/>	<input type="checkbox"/>	<input type="checkbox"/>	<input type="checkbox"/>	<input type="checkbox"/>	<input type="checkbox"/>	<input type="checkbox"/>	<input type="checkbox"/>	<input type="checkbox"/>	<input type="checkbox"/>	
 Quick Control screen		<input type="checkbox"/>	<input type="checkbox"/>	<input type="checkbox"/>	<input type="checkbox"/>	<input type="checkbox"/>	<input type="checkbox"/>	<input type="checkbox"/>	<input type="checkbox"/>	<input type="checkbox"/>	<input type="checkbox"/>	
 Magnify/Reduce		<input type="checkbox"/>	<input type="checkbox"/>	<input type="checkbox"/>	<input type="checkbox"/>	<input type="checkbox"/>	<input type="checkbox"/>	<input type="checkbox"/>	<input type="checkbox"/>	<input type="checkbox"/>	<input type="checkbox"/>	
 Image replay											<input type="checkbox"/>	
 Magnify images during playback		<input type="checkbox"/>	<input type="checkbox"/>	<input type="checkbox"/>	<input type="checkbox"/>	<input type="checkbox"/>	<input type="checkbox"/>	<input type="checkbox"/>	<input type="checkbox"/>	<input type="checkbox"/>	<input type="checkbox"/>	
 Register/recall shooting func <sup>1</sup>				<input type="checkbox"/>	<input type="checkbox"/>	<input type="checkbox"/>	<input type="checkbox"/>	<input type="checkbox"/>				
<b>MENU</b> Menu display		<input type="checkbox"/>	<input type="checkbox"/>	<input type="checkbox"/>	<input type="checkbox"/>	<input type="checkbox"/>	<input type="checkbox"/>	<input type="checkbox"/>	<input type="checkbox"/>	<input type="checkbox"/>	<input type="checkbox"/>	
 Touch Shutter <sup>1</sup>		<input type="checkbox"/>	<input type="checkbox"/>	<input type="checkbox"/>	<input type="checkbox"/>	<input type="checkbox"/>	<input type="checkbox"/>	<input type="checkbox"/>	<input type="checkbox"/>	<input type="checkbox"/>	<input type="checkbox"/>	
 Create folder <sup>1</sup>		<input type="checkbox"/>	<input type="checkbox"/>	<input type="checkbox"/>	<input type="checkbox"/>	<input type="checkbox"/>	<input type="checkbox"/>	<input type="checkbox"/>	<input type="checkbox"/>	<input type="checkbox"/>	<input type="checkbox"/>	
 Maximize screen brightness (temp)		<input type="checkbox"/>	<input type="checkbox"/>	<input type="checkbox"/>	<input type="checkbox"/>	<input type="checkbox"/>	<input type="checkbox"/>	<input type="checkbox"/>	<input type="checkbox"/>	<input type="checkbox"/>	<input type="checkbox"/>	
 Display off		<input type="checkbox"/>	<input type="checkbox"/>	<input type="checkbox"/>	<input type="checkbox"/>	<input type="checkbox"/>	<input type="checkbox"/>	<input type="checkbox"/>	<input type="checkbox"/>	<input type="checkbox"/>	<input type="checkbox"/>	

 Switch between VF/screen		<input type="radio"/>	<input type="radio"/>	<input type="radio"/>	<input type="radio"/>	<input type="radio"/>	<input type="radio"/>	<input type="radio"/>	<input type="radio"/>	<input type="radio"/>	<input type="radio"/>	
<b>ECO</b> Eco mode		<input type="radio"/>	<input type="radio"/>	<input type="radio"/>	<input type="radio"/>	<input type="radio"/>	<input type="radio"/>	<input type="radio"/>	<input type="radio"/>	<input type="radio"/>	<input type="radio"/>	
 Wi-Fi function		<input type="radio"/>	<input type="radio"/>	<input type="radio"/>	<input type="radio"/>	<input type="radio"/>	<input type="radio"/>	<input type="radio"/>	<input type="radio"/>	<input type="radio"/>	<input type="radio"/>	
<b>OFF</b> No function (disabled)		<input type="radio"/>	<input type="radio"/>	<input type="radio"/>	<input type="radio"/>	<input type="radio"/>	<input type="radio"/> *3	<input type="radio"/>	<input type="radio"/>	<input type="radio"/>	<input type="radio"/>	<input checked="" type="radio"/>

\* 1: Cannot be assigned as a function available in movie recording.

\* 3: Default in movie recording.





\* 4: Default in still photo shooting.



#### Note

- **[LENS]**: "AF stop button" on Image Stabilizer-equipped super telephoto lenses.

## Customize dials

Frequently used functions can be assigned to the <  > / <  > / <  > / <  > dials.

### 1. Select [: Customize dials].

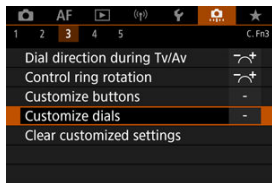



### 2. Select a part of the bar.



### 3. Select a function to assign.



- Press <  > to set it.
- You can configure advanced settings for functions labeled with [**INFO**] in the lower left of the screen by pressing the <  > button.















#### Note

- [F10: Customize dials] settings are not cleared even if you select [F10: Clear all Custom Func. (C.Fn)]. To clear the settings, select [F10: Clear customized settings].

## Functions available for dials



●: Default ○: Available for customization

	Function				
<b>AF</b> □	Select AF method		○	○	○
	Direct AF point selection		○	○	
<b>AF</b> □ ↓	AF method (hold meter. btn)				○
<b>Tv</b>	Change shutter speed				○
<b>Av</b>	Change aperture value				○
	Exposure compensation		○	○	○
<b>ISO</b>	Set ISO speed		●	○	○
<b>Tv</b> ↓	Change shutter spd. (hold meter. btn)				○
<b>Av</b> ↓	Change aperture (hold meter. btn)				○
 ↓	Exposure comp. (hold meter. btn)				●
<b>ISO</b> ↓	Set ISO speed (hold meter. btn)				○
 ↓	Flash exp comp (hold meter. btn)				○
<b>Tv</b>	Shutter speed setting in M mode	●	○	○	
<b>Av</b>	Aperture setting in M mode	○	○	●	
<b>WB</b>	White balance selection		○	○	○
	Select color temperature		○	○	○
	Picture Style		○	○	○
<b>WB</b> ↓	Select WB (hold meter. btn)				○
 ↓	Color temp. (hold meter. btn)				○
 ↓	Select  (hold meter. btn)				○
<b>OFF</b>	No function (disabled)	○	○	○	○





## Note

- <  > and <  > dials cannot be customized in **[Fv]** mode.
- <  >: Control ring on RF lenses and mount adapters.

## Clear customized settings

1. Select [: Clear customized settings].

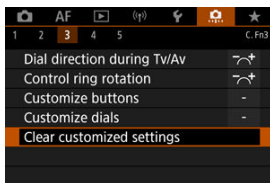

2. Select [OK].

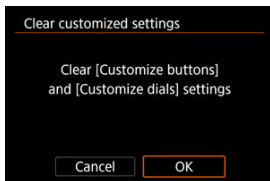

- [Customize buttons] and [Customize dials] are restored to defaults.



### Add cropping information

Adding cropping information displays vertical lines for the aspect ratio specified in shooting, so that you can compose shots as if shooting with a medium- or large-format camera (6×6 cm, 4×5 inch, and so on).

When you shoot, instead of cropping images recorded to the card, the camera adds aspect ratio information to images for cropping in the Digital Photo Professional (EOS software). You can import images to Digital Photo Professional on a computer and easily crop images to the aspect ratio set at the time of shooting.

- **OFF: Disable**
- **6:6: Aspect ratio 6:6**
- **3:4: Aspect ratio 3:4**
- **4:5: Aspect ratio 4:5**
- **6:7: Aspect ratio 6:7**
- **5:6: Aspect ratio 10:12**
- **5:7: Aspect ratio 5:7**

#### Caution

- Cropping information can only be added when [:  **Cropping/aspect ratio**] is set to [**Full-frame**].
- JPEG or HEIF images are not saved at the cropped size if you use the camera to process RAW images with cropping information (). In this case, RAW processing produces JPEG or HEIF images with cropping information.

#### Note

- Vertical lines indicating your specified aspect ratio are displayed on the screen.

## Audio compression



Sets audio compression for movie recording. **[Disable]** allows higher audio quality than when audio is compressed, but file sizes are larger.

- **ON: Enable**
- **OFF: Disable**



### ⚠ Caution

- Editing movie files recorded with **[Disable]** and then saving them with compression will also compress the audio.
- Audio is compressed in **[A+]** mode when **[Movie rec quality]** is set to **FHD 29.97P** **[PB]** (NTSC) or **FHD 25.00P** **[PB]** (PAL), even if **[Disable]** is selected.

## Default Erase option

You can set which option is selected by default in the erase menu () , which is accessed by pressing the <  > button during image playback or during review after shooting.

By setting an option other than **[Cancel]**, you can simply press <  > to erase images quickly.

- : **[Cancel]** selected
- : **[Erase]** selected
- **RAW**: **[Erase RAW]** selected
- **J/H**: **[Erase non-RAW]** selected

### ⚠ Caution

- Be careful not to erase images accidentally when an option other than **[Cancel]** is set.

## Release shutter w/o lens

You can specify whether shooting still photos or movies is possible without a lens attached.

- **OFF: Disable**
- **ON: Enable**

## Retract lens on power off

You can set whether to retract gear-type STM lenses (such as EF40mm f/2.8 STM) automatically when the camera's power switch is set to < **OFF** >.

- **ON: Enable**
- **OFF: Disable**

### Caution

- With auto power off, the lens will not retract regardless of the setting.
- Before detaching the lens, make sure that it is retracted.

### Note

- When [**Enable**] is set, this function takes effect regardless of the lens's focus mode switch setting (AF or MF).

## Add IPTC information

Registering IPTC (International Press Telecommunications Council) information to the camera from EOS Utility (EOS software) enables you to record (add) this information to JPEG/HEIF/RAW still photos at the time of shooting. **This is helpful in file management and other tasks using the IPTC information.**



**For instructions on registering IPTC information to the camera and details on the information you can register, refer to the EOS Utility Instruction Manual.**

- OFF: Disable
- ON: Enable

### Caution

- IPTC information is not added when you record movies.

### Note





- During playback, you can check whether IPTC information was added.
- You can use Digital Photo Professional (EOS software) to check IPTC information in images.
- IPTC information registered to the camera is not erased if you select [: Clear all Custom Func. (C.Fn)] (), but the setting changes to [Disable].

### Clear all Custom Func. (C.Fn)

Selecting [: **Clear all Custom Func. (C.Fn)**] clears all Custom Function settings except [**Customize buttons**] and [**Customize dials**].



#### Note

- Performing [: **Clear all Custom Func. (C.Fn)**] does not clear settings configured in [: **Customize buttons**] and [: **Customize dials**]. To clear the settings, select [: **Clear customized settings**]. Note that although information added using [: **Add IPTC information**] is retained, the setting changes to [**Disable**].

## Tab Menus: My Menu

---

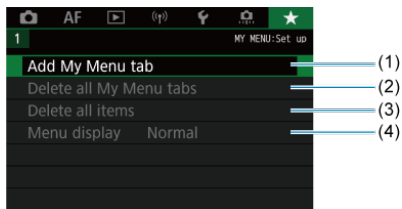

- (1) [Add My Menu tab](#)
- (2) [Delete all My Menu tabs](#)
- (3) [Delete all items](#)
- (4) [Menu display](#)



## Registering My Menu

---

- [Creating and Adding My Menu Tabs](#)
- [Registering Menu Items on My Menu Tabs](#)
- [My Menu Tab Settings](#)
- [Deleting All My Menu Tabs/Deleting All Items](#)
- [Menu Display Settings](#)

On the My Menu tab, you can register menu items and Custom Functions you often adjust.

---

## Creating and Adding My Menu Tabs

---

1. Select [Add My Menu tab].

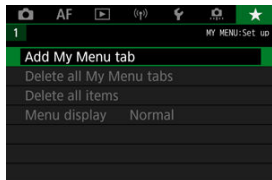

2. Select [OK].

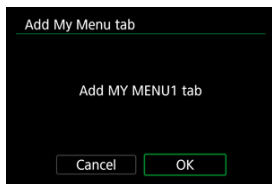

- You can create up to five My Menu tabs by repeating steps 1 and 2.

1. Select [MY MENU\*: Configure].

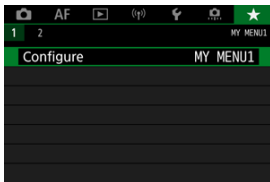

2. Select [Select items to register].

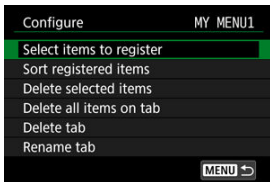

3. Register the desired items.

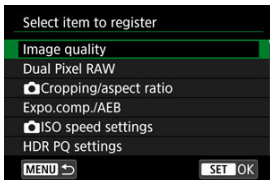



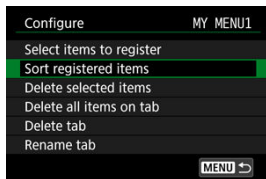

- Select an item, then press < (SET) >.
- Select [OK] on the confirmation screen.
- You can register up to six items.
- To return to the screen in step 2, press the < MENU > button.

## My Menu Tab Settings



You can sort and delete items on the menu tab, and rename or delete the menu tab itself.

- **Sort registered items**

You can change the order of the registered items in My Menu. Select [**Sort registered items**], select an item to rearrange, then press <  >. With [] displayed, turn the <  > dial to rearrange the item, then press <  >.

- **Delete selected items/Delete all items on tab**

You can delete any of the registered items. [**Delete selected items**] deletes one item at a time, and [**Delete all items on tab**] deletes all the registered items on the tab.

- **Delete tab**

You can delete the current My Menu tab. Select [**Delete tab**] to delete the [**MY MENU\***] tab.

- **Rename tab**

You can rename the My Menu tab from [MY MENU\*].

1. Select [Rename tab].

2. Enter text.

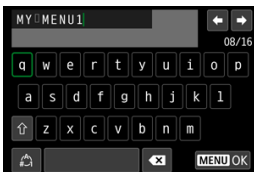

- To delete single characters, select [X] or press the < [trash] > button.
- Use the < [dial] > or < [dial] > dial or < [asterisk] > to select a character, then press < [SET] > to enter it.
- By selecting [↑], you can change the input mode.

3. Confirm input.

- Press the < MENU > button, then select [OK].

## Deleting All My Menu Tabs/Deleting All Items

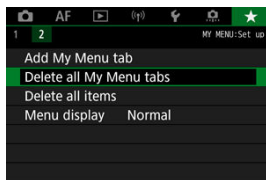

You can delete all the created My Menu tabs or My Menu items registered on them.

- **Delete all My Menu tabs**

You can delete all My Menu tabs you created. When you select [**Delete all My Menu tabs**], all the tabs from [**MY MENU1**] to [**MY MENU5**] will be deleted and the [**★**] tab will revert to its default.

- **Delete all items**

You can delete all the items registered under the [**MY MENU1**] to [**MY MENU5**] tabs. The tabs themselves will remain. When [**Delete all items**] is selected, all the items registered on all the created tabs will be deleted.

### Caution

- Performing [**Delete tab**] or [**Delete all My Menu tabs**] will also delete tab names renamed with [**Rename tab**].

## Menu Display Settings

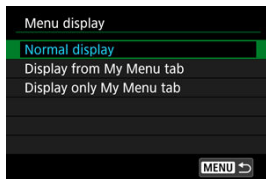

You can select **[Menu display]** to set the menu screen that is to appear first when you press the <MENU> button.

- **Normal display**

Displays the last displayed menu screen.

- **Display from My Menu tab**

Displays with the [★] tab selected.

- **Display only My Menu tab**

Restricts display to the [★] tab ([📷]/[AF]/[▶]/[⏮]/[⏪]/[⏩]/[🔍] tabs are not displayed).

## Reference

---

This chapter provides reference information on camera features.

- [Importing Images to a Computer](#)
- [Using a USB Power Adapter to Charge/Power the Camera](#)
- [Using a Battery Grip](#)
- [Troubleshooting Guide](#)
- [Error Codes](#)
- [System Map](#)
- [ISO Speed in Movie Recording](#)
- [Information Display](#)
- [EF Lenses Supporting 12 Shots/Sec. Continuous Shooting](#)
- [Specifications](#)



## Importing Images to a Computer

---

[Connecting to a Computer with an Interface Cable](#)

[Using a Card Reader](#)

[Connecting to a Computer via Wi-Fi](#)

You can use EOS software to import images from the camera to a computer. There are three ways to do this.

---

### Connecting to a Computer with an Interface Cable

---

1. Install EOS Utility .
2. Connect the camera to the computer.

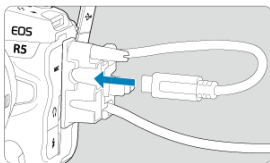

- Use the interface cable included with the camera.
  - When connecting the cable to the camera, use the cable protector  and insert the plug in the digital terminal.
  - Insert the other end of the cable into the computer's USB terminal (Type-C).
3. Use EOS Utility to import the images.
    - Refer to the EOS Utility Instruction Manual.

 **Caution**

- With a Wi-Fi connection established, the camera cannot communicate with the computer even if they are connected with an interface cable.

## Using a Card Reader

---

You can use a card reader to import images to a computer.

1. **Install Digital Photo Professional** .
2. **Insert the card into the card reader.**
3. **Use Digital Photo Professional to import the images.**

- Refer to the Digital Photo Professional Instruction Manual.



### Note

- When downloading images from the camera to a computer with a card reader without using EOS software, copy the DCIM folder on the card to the computer.

## Connecting to a Computer via Wi-Fi

---

You can connect the camera to the computer via Wi-Fi and import images to the computer (🔗).



### Note

- By connecting to an FTP server, you can send images on the camera to a computer (🔗).

## Using a USB Power Adapter to Charge/Power the Camera

---

Using USB Power Adapter PD-E1 (sold separately), you can charge Battery Pack LP-E6NH or LP-E6N without removing it from the camera. The camera can also be powered. **Note that Battery Pack LP-E6 cannot be charged this way.**

---

### Charging

1. Connect the USB power adapter.

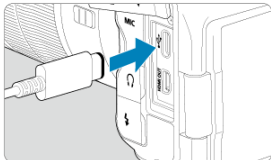

- With the camera power switch set to <OFF>, insert the USB power adapter plug fully into the digital terminal.

## 2. Connect the power cord.

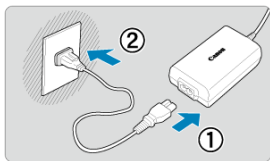

- Connect the power cord to the USB power adapter and plug the other end into a power outlet.
- Charging begins, and the access lamp (1) is lit in green.
- [⚡] is displayed on the LCD panel.

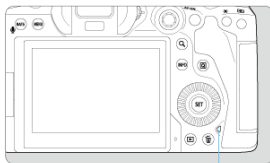

(1)

- When charging is finished, the access lamp turns off.

## Supplying power

To power the camera without charging, set the camera power switch to <ON>. However, batteries are charged during auto power off.

[⚡] is displayed on the LCD panel and screen while the camera is powered.

To change from powering the camera to charging, set the camera power switch to <OFF>.

 **Caution**

- The camera cannot be powered unless a battery pack is in it.
- When batteries are depleted, the adapter charges them. In this case, power is not supplied to the camera.
- To protect the battery pack and keep it in optimal condition, do not charge it continuously for more than 24 hours.
- If the charging lamp fails to light up or a problem occurs during charging (shown by the access lamp blinking in green), unplug the power cord, reinsert the battery, and wait a few minutes before plugging it in again. If the problem persists, take the camera to the nearest Canon Service Center.
- The charging time required and the amount charged vary depending on ambient temperature and remaining capacity.
- For safety, charging in low temperatures takes longer.
- The remaining battery level may decline when power is supplied to the camera. To avoid running out of battery power, use a fully charged battery when shooting at regular intervals.

# Using a Battery Grip

---

- ☑ [Attaching Batteries](#)
- ☑ [Using a Household Power Outlet](#)
- ☑ [Button and Dial Operations](#)
- ☑ [Using a USB Power Adapter to Charge/Power the Camera](#)

Equipped with buttons and dials for vertical shooting, Battery Grip BG-R10 is an optional camera accessory that can power the camera with two batteries.

---

## 1. Remove the contact covers.

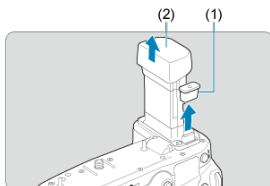

- Remove contact covers (1) and (2) on the battery grip.

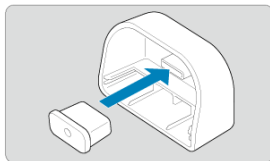

- Attach the battery grip contact cover (1) to (2) to store them.



## 2. Remove the battery compartment cover.

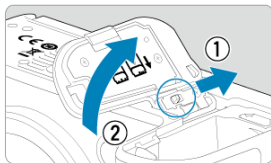

- Turn off the camera before removing the battery.
- Remove the battery compartment cover from the camera.

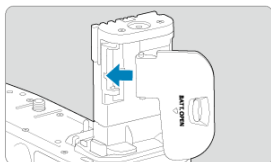

- Attach the cover to the battery grip.

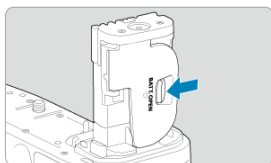

- To remove the cover, slide the lever to release it, following the attachment procedure in reverse.

### 3. Attach and lock the battery grip.

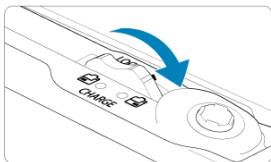
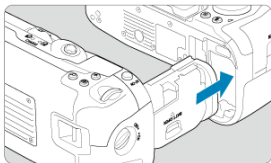

- Insert the battery grip in the camera and turn the release dial to lock it in place.

### 4. Remove the battery magazine.

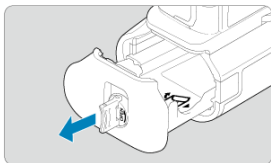
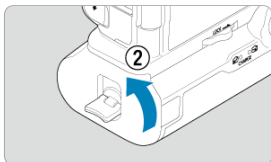
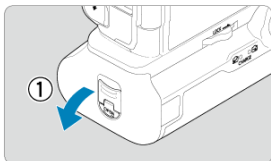

 **Caution**

- When reattaching the battery compartment cover to the camera, attach it opened to at least 90°.
- Do not touch the camera or battery grip contacts.

## Attaching Batteries

### 1. Attach the batteries.

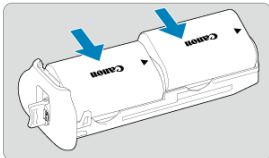

- Insert the batteries as shown.
- When only one battery is used, it can be inserted in either position.

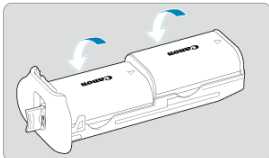

- To secure the batteries, push in the direction of the arrows until they click into place.

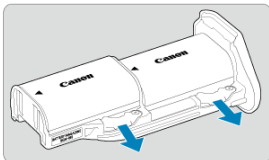

- To remove the batteries, press the battery magazine lever in the direction of the arrow.

## 2. Attach the battery magazine.

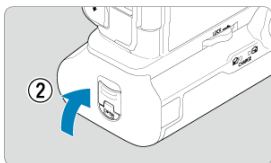
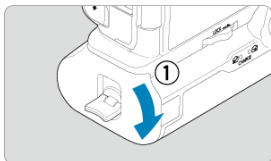
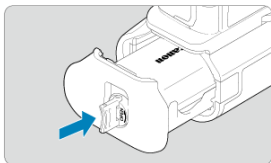

- Insert the battery magazine all the way in to secure it.

### Caution

- When attaching batteries, make sure the electrical contacts are clean. Wipe off any dirt on the contacts with a soft cloth.
- Attach batteries after attaching the battery grip to the camera. If the battery grip is attached to the camera with batteries already attached, it may prevent correct display of battery check results.
- Before removing the battery grip, turn the camera off and remove the batteries.
- Reattach the protective covers for the camera and battery grip contacts after removing the battery grip. If the battery grip will not be used for some time, remove the batteries.
- If a battery communication error message is displayed when a battery grip is attached, follow the instructions in the message. If the camera loses power, reinstall the battery magazine and restart the camera.

## Using a Household Power Outlet

### 1. Attach the DC coupler.

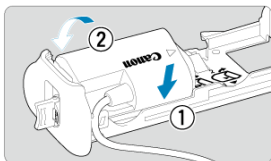

- Attach DC Coupler DR-E6 (sold separately) the same way as the batteries.

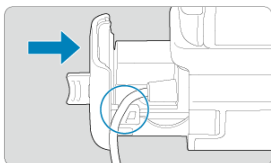

- Pass the DC coupler cord through the battery magazine cord groove.
- Insert the battery magazine all the way in to secure it.

### 2. Attach the battery magazine.

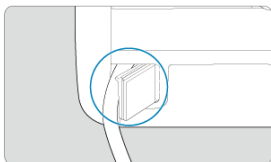

- Guide the end of the cord out of the cord hole.

### 3. Connect the DC coupler to the AC adapter.

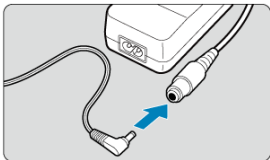

- Fully insert the DC coupler plug into the socket of AC Adapter AC-E6N (sold separately).

### 4. Connect the power cord.

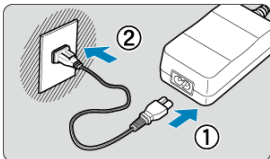

- Connect the power cord to the AC adapter and insert the power plug into a power outlet.

#### ⚠ Caution

- While the camera is on, do not connect or disconnect the power cord or socket, and do not remove the battery magazine.
- Avoid getting the DC coupler cord caught between the battery grip and battery magazine.

## Button and Dial Operations

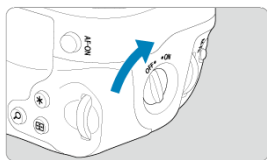

- To use the buttons and dials, turn the vertical-grip on/off switch (4) to ON.
- The buttons and dials are used the same way as corresponding buttons and dials on the camera.

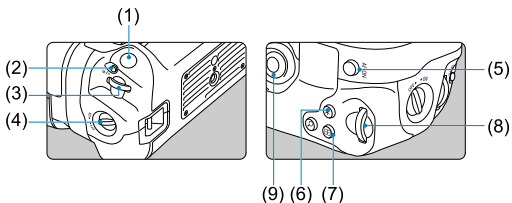

- |      |   |
|------|---|
| (1)  | Shutter button  |
| (2)  | <M-Fn> Multi-function button                          |
| (3)  | <Main dial> Main dial                                 |
| (4)  | Vertical-grip On/Off switch                           |
| (5)  | <Multi-controller> Multi-controller                   |
| (6)  | <Magnify/Reduce button> Magnify/Reduce button         |
| (7)  | <AF point selection button> AF point selection button |
| (8)  | <AE lock/FE lock button> AE lock/FE lock button       |
| (9)  | <AF-ON> AF start button                               |
| (10) | <Quick control dial 2> Quick control dial 2           |



## Using a USB Power Adapter to Charge/Power the Camera

Using USB Power Adapter PD-E1, you can charge Battery Pack LP-E6NH or LP-E6N without removing it from the battery grip. The camera can also be powered.

### ⚠ Caution

- LP-E6NH and LP-E6N can be charged together.
- Otherwise, you can charge a single LP-E6NH or LP-E6N battery at a time.
- LP-E6 cannot be charged this way. No battery will be charged if LP-E6NH or LP-E6N is attached at the same time as LP-E6.
- The battery is not charged if LP-E6NH or LP-E6N is loaded when DC Coupler DR-E6 is connected.
- Charging stops if you operate the camera.
- When batteries are depleted, the adapter charges them. In this case, power is not supplied to the camera.

## Charging

### 1. Connect the USB power adapter.

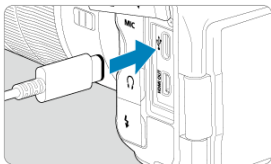

- With the camera power switch set to <OFF>, insert the USB power adapter plug fully into the camera's digital terminal.

## 2. Charge the battery.

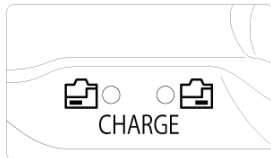
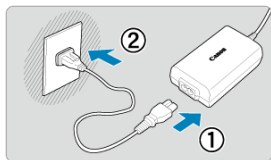

- Connect the power cord to the USB power adapter and plug the other end into a power outlet.
- Charging begins, and the charge lamp lights up.
- [⚡] is displayed on the LCD panel.
- When charging is finished, the charge lamp turns off.

## Supplying power

To power the camera without charging batteries, set the camera power switch to < ON >.

[🔋] is displayed on the LCD panel and screen while the camera is powered.

To change from powering the camera to charging, set the camera power switch to < OFF >.

 **Caution**

- To protect the battery pack and keep it in optimal condition, do not charge it continuously for more than 24 hours.
- If the charging lamp fails to light up or a problem occurs during charging (shown by the charge lamp blinking), unplug the power cord, reinsert the battery, and wait a few minutes before plugging it in again. If the problem persists, take the camera to the nearest Canon Service Center.
- The charging time required and the amount charged vary depending on ambient temperature and remaining capacity.
- For safety, charging in low temperatures takes longer.
- The remaining battery level may decline when power is supplied to the camera. To avoid running out of battery power, use a fully charged battery when shooting at regular intervals.

# Troubleshooting Guide

---

- [✔ Power-related problems](#)
- [✔ Shooting-related problems](#)
- [✔ Problems with wireless features](#)
- [✔ Operation problems](#)
- [✔ Display problems](#)
- [✔ Playback problems](#)
- [✔ Sensor cleaning problems](#)
- [✔ Computer connection problems](#)

If a problem occurs with the camera, first refer to this Troubleshooting Guide. If this Troubleshooting Guide does not resolve the problem, take the camera to the nearest Canon Service Center.

## Power-related problems

### Batteries cannot be charged with the battery charger.

---

- If the battery's remaining capacity (🔋) is 94% or higher, the battery will not be charged.
- Do not use any battery packs other than a genuine Canon Battery Pack LP-E6NH/LP-E6N/LP-E6.
- In case of charging or charger issues, see [Charging the Battery](#).

### The charger's lamp blinks at high speed.

---

- If (1) the battery charger or battery has a problem or (2) communication with the battery failed (with a non-Canon battery pack), the protection circuit will stop charging, and the charge lamp will blink in orange at a constant high speed. In the case of (1), unplug the charger's power plug from the power outlet, reattach the battery, wait a few minutes, and then reconnect the power plug to the power outlet. If the problem persists, take the camera to the nearest Canon Service Center.

### The charger's lamp does not blink.

---

- If the internal temperature of the battery attached to the charger is high, the charger will not charge the battery for safety reasons (lamp off). During charging, if the battery's temperature becomes high for any reason, charging will stop automatically (lamp blinks). When the battery temperature goes down, charging will resume automatically.

## **Batteries cannot be charged with the USB power adapter (sold separately).**

---

- Batteries are not charged while the camera power switch is set to < ON >. However, batteries are charged during auto power off.
- Battery Pack LP-E6 cannot be charged.
- Batteries are not charged when their remaining capacity is already approx. 94% or higher.
- Operating the camera will stop charging in progress.

## **The access lamp blinks during charging with the USB power adapter.**

---

- In case of charging problems, the access lamp blinks in green and a protective circuit stops charging. In this case, unplug the power cord, reattach the battery, and wait a few minutes before plugging it in again. If the problem persists, take the camera to the nearest Canon Service Center.

## **The access lamp is not lit during charging with the USB power adapter.**

---

- Try unplugging the USB power adapter and plugging it in again.

## **The camera cannot be powered with the USB power adapter.**

---

- Check the battery compartment. The camera cannot be powered without a battery pack.
- Check the remaining battery level. When batteries are depleted, the adapter charges them. In this case, power is not supplied to the camera.

## **The camera is not activated even when the power switch is set to < ON >.**

---

- Make sure the battery is inserted properly in the camera (🔗).
- Make sure the card slot cover is closed (🔗).
- Charge the battery (🔗).

## **The access lamp still lights or blinks even when the power switch is set to < OFF >.**

---

- If the power is turned off while an image is being recorded to the card, the access lamp will remain on or continue to blink for a few seconds. When the image recording is complete, the power will turn off automatically.

## **[Battery communication error. Does this battery/do these batteries display the Canon logo?] is displayed.**

---

- Do not use any battery packs other than a genuine Canon Battery Pack LP-E6NH/LP-E6N/LP-E6.
- Remove and install the battery again (🔧).
- If the electrical contacts are dirty, use a soft cloth to clean them.

## **The battery becomes exhausted quickly.**

---

- Use a fully charged battery (🔧).
- The battery performance may have degraded. See [🔧: **Battery info.**] to check the battery recharge performance level (🔧). If the battery performance is poor, replace the battery with a new one.
- The number of available shots will decrease with any of the following operations:
  - Pressing the shutter button halfway for a prolonged period
  - Activating the AF frequently without taking a picture
  - Using the lens's Image Stabilizer
  - Using the wireless communication functions

## **The camera turns off by itself.**

---

- Auto power off is in effect. To deactivate auto power off, set [**Auto power off**] in [🔧: **Power saving**] to [**Disable**] (🔧).
- Even if [**Auto power off**] is set to [**Disable**], the screen and viewfinder will still turn off after the camera is left idle for the time set in [**Display off**] or [**Viewfinder off**] (although the camera itself remains on).
- Set [🔧: **Eco mode**] to [**Off**].

## Shooting-related problems

### The lens cannot be attached.

---

- To attach EF or EF-S lenses, you will need a mount adapter. The camera cannot be used with EF-M lenses (🔗).

### No images can be shot or recorded.

---

- Make sure the card is properly inserted (🔗).
- Slide the card's write-protect switch to the Write/Erase setting (🔗).
- If the card is full, replace the card or delete unnecessary images to make space (🔗, 🔗).
- Shooting is not possible if the AF point turns orange when you attempt to focus. Press the shutter button halfway again to refocus automatically, or focus manually (🔗, 🔗).

### The card cannot be used.

---

- If a card error message is displayed, see [Inserting/Removing Cards](#) and [Error Codes](#).

### An error message is displayed when the card is inserted in another camera.

---

- Since SDXC cards are formatted in exFAT, if you format a card with this camera and then insert it into another camera, an error may be displayed and it may not be possible to use the card.

### The image is out of focus or blurred.

---

- Set the lens's focus mode switch to < AF > (🔗).
- Press the shutter button gently to prevent camera shake (🔗).
- With a lens equipped with an Image Stabilizer, set the Image Stabilizer switch to < ON >.
- In low light, the shutter speed may become slow. Use a faster shutter speed (🔗), set a higher ISO speed (🔗), use flash (🔗), or use a tripod.
- See [Minimizing blurred photos](#).

### I cannot lock the focus and recompose the shot.

---

- Set the AF operation to One-Shot AF (🔗). Shooting with the focus locked is not possible with Servo AF (🔗).

## The continuous shooting speed is slow.

---

- High-speed continuous shooting may be slower depending on the battery level, ambient temperature, flicker reduction, shutter speed, aperture value, subject conditions, brightness, AF operation, type of lens, use of flash, shooting settings, and other conditions. For details, see [Selecting the Drive Mode](#) or [Still photo file size / Number of possible shots / Maximum burst for continuous shooting](#).

## The maximum burst during continuous shooting is lower.

---

- Shooting intricate subjects such as fields of grass may result in larger file sizes, and the actual maximum burst may be lower than the guidelines in [Still photo file size / Number of possible shots / Maximum burst for continuous shooting](#).

## Even after I change the card, the maximum burst displayed for continuous shooting does not change.

---

- Estimated maximum burst indicated in the viewfinder does not change when you switch cards, even if you switch to a high-speed card. Maximum burst listed in [Still photo file size / Number of possible shots / Maximum burst for continuous shooting](#) is based on the standard Canon test card, and the actual maximum burst is higher for cards with faster writing speeds. For this reason, estimated maximum burst may differ from actual maximum burst.





## High-speed display is not available during high-speed continuous shooting.

---

- Refer to the high-speed display requirements in [High-Speed Display](#).

## Some image quality options are not available with cropped shooting.

---

-     image quality options are not available when [1.6x (crop)] is set, or with EF-S lenses.

## The aspect ratio cannot be set.

---

- Aspect ratios cannot be set for EF-S lenses ([1.6x (crop)] is set automatically).
- Aspect ratios cannot be set when [: Add cropping information] is set to an option other than [Disable].

## ISO 100 cannot be set for still photo shooting.

---

- The minimum speed in the ISO speed range is ISO 200 when [: Highlight tone priority] is set to [Enable] or [Enhanced].



## Expanded ISO speeds cannot be selected for still photo shooting.

---

- Check the [ISO speed range] setting under [📷: ISO speed settings].
- Expanded ISO speeds are not available when [📷: Highlight tone priority] is set to [Enable] or [Enhanced].
- Expanded ISO speeds are not available when [HDR shooting HDR PQ] in [📷: HDR PQ settings] is set to [Enable].

## Even if I set a decreased exposure compensation, the image comes out bright.

---

- Set [📷: Auto Lighting Optimizer] to [Disable] (🔒). When [Low], [Standard], or [High] is set, even if you set a decreased exposure compensation or flash exposure compensation, the image may come out bright.

## I cannot set the exposure compensation when both manual exposure and ISO Auto are set.

---

- See [M: Manual Exposure](#) to set the exposure compensation.

## Not all the lens aberration correction options are displayed.

---

- With [Digital Lens Optimizer] set to [Standard] or [High], [Chromatic aberr corr] and [Diffraction correction] are not displayed, but they are both set to [Enable] for shooting.
- [Digital Lens Optimizer] is not displayed in movie recording.

## Images are not displayed after shooting in multiple-exposure shooting.

---

- When [On:ContShtng] is set, images are not displayed for review after capture, and image playback is not available (🔒).

## Using flash in [AV] or [P] mode lowers the shutter speed.

---

- Set [Slow synchro] in [📷: External Speedlite control] to [1/250-1/60sec. auto] (or [1/200-1/60sec. auto]) or [1/250 sec. (fixed)] (or [1/200 sec. (fixed)]) (🔒).

## The flash does not fire.

---

- Make sure any flash units are securely attached to the camera.

## The flash always fires at full output.

---

- Flash units other than EL/EX series Speedlites used in autoflash mode always fire at full output (🔒).
- When the flash Custom Function setting for **[Flash metering mode]** is set to **[TTL flash metering]** (autoflash), the flash will always fire at full output (🔒).

## Flash exposure compensation cannot be set.

---

- If flash exposure compensation is already set with the Speedlite, flash exposure compensation cannot be set with the camera. When the Speedlite's flash exposure compensation is canceled (set to 0), flash exposure compensation can be set with the camera.

## High-speed sync is not available in **[AV]** or **[FV]** mode.

---

- Set **[Slow synchro]** in **[📷: External Speedlite control]** to an option other than **[1/250 sec. (fixed)]** (or **[1/200 sec. (fixed)]**) (🔒).

## Remote control shooting is not possible.

---

- In still photo shooting, set the drive mode to **[iS]** or **[iS2]** (🔒). In movie recording, set **[📷: Remote control]** to **[Enable]** (🔒).
- Check the position of the remote control's release timing switch.
- If you are using Wireless Remote Control BR-E1, see [Remote Control Shooting](#) or [Connecting to a Wireless Remote Control](#).
- Infrared remote controllers such as the RC-6 cannot be used for remote control shooting when the camera is paired via Bluetooth with a smartphone or wireless remote control. Set **[Bluetooth settings]** to **[Disable]**.
- To use a remote control for time-lapse movie recording, see [Time-Lapse Movies](#).

## A white **[🔥]** or red **[🔥]** icon is displayed during shooting.

---

- It indicates that the camera's internal temperature is high. Image quality of still photos may be worse when a white **[🔥]** icon is displayed. Display of a red **[🔥]** icon indicates that shooting will soon stop automatically (🔒).



## A red **[🔥]** icon is displayed during movie recording.

---

- It indicates that the camera's internal temperature is high. If the red **[🔥]** icon is displayed, it indicates that the movie recording will soon stop automatically (🔒).

## A icon is displayed during movie recording.

---

- It indicates that the camera's internal temperature is high. Movie recording is not possible as long as  is displayed. Display of  during movie recording also indicates that the camera will turn off automatically in approx. 3 min. .





## Movie recording stops by itself.

---

- If the card's writing speed is slow, movie recording may stop automatically. For details on cards that can record movies, see [Card performance requirements](#). To find out the card's writing speed, refer to the card manufacturer's website, etc.
- Perform low-level formatting to initialize the card if the card's writing or reading speed seems slow .
- Recording stops automatically once your movie reaches 29 min. 59 sec. (or 7 min. 29 sec. for a High Frame Rate movie).



## The ISO speed cannot be set for movie recording.

---

- ISO speed is set automatically in  recording mode. In  mode, you can manually set the ISO speed .
- The minimum speed in the ISO speed range is ISO 200 when : **Highlight tone priority** is set to **[Enable]** or **[Enhanced]**.

## Expanded ISO speeds cannot be selected for movie recording.

---

- Check the **[ISO speed range]** setting under : **ISO speed settings**.
- Expanded ISO speeds are not available when : **Highlight tone priority** is set to **[Enable]** or **[Enhanced]**.

## The exposure changes during movie recording.

---

- If you change the shutter speed or aperture value during movie recording, the changes in the exposure may be recorded.
- Recording a few test movies is recommended if you intend to perform zooming during movie recording. Zooming as you record movies may cause exposure changes or lens sounds to be recorded, or loss of focus.

## The image flickers or horizontal stripes appear during movie recording.

---

- Flickering, horizontal stripes (noise), or irregular exposures can be caused by fluorescent lighting, LED lighting, or other light sources during movie recording. Also, changes in the exposure (brightness) or color tone may be recorded. In  mode, using a slower shutter speed may reduce the problem. The problem may be more noticeable in time-lapse movie recording.

## The subject looks distorted during movie recording.

---

- If you move the camera to the left or right (panning) or shoot a moving subject, the image may look distorted. The problem may be more noticeable in time-lapse movie recording.

## Sound is not recorded in movies.

---

- Sound is not recorded in High Frame Rate movies.

## A time code is not added.

---

- Time codes are not added when you record High Frame Rate movies with **[Count up]** in **[📷: Time code]** set to **[Free run]** (🔗). Additionally, no time code is added to HDMI video output (🔗).

## Time codes advance faster than the actual time.

---

- Time codes in High Frame Rate movie recording advance 4 sec. per second (🔗).

## I cannot take still photos during movie recording.

---

- Still photos cannot be taken during movie recording. To shoot still photos, stop recording the movie, then select a shooting mode for still photos.

## I cannot record movies during still photo shooting.

---

- It may not be possible to record movies during still photo shooting if operations such as extended Live View display increase the camera's internal temperature. Turn off the camera or take other measures, and wait until the camera cools down.
- In **[A+]** shooting mode, lowering the **[A+]** movie recording quality may enable movie recording.
- In shooting modes other than **[A+]**, lowering the **[P]** movie recording quality may enable movie recording.

## Cannot record movies.

---

- Format (initialize) the card with this camera (🔗).
- Use an SDXC card as card **[2]** when the movie recording method is set to **[RAW]** or **[MP4]**.

## The camera vibrates.

---

- Image stabilization by the camera may make the camera seem to vibrate. This does not indicate damage.

### Cannot pair with a smartphone.

---

- Use a smartphone compliant with Bluetooth Specification Version 4.1 or later.
- Turn on Bluetooth from the smartphone settings screen.
- Pairing with the camera is not possible from the smartphone's Bluetooth settings screen. Install the dedicated app Camera Connect (free of charge) on the smartphone (📄).
- Pairing with a previously paired smartphone is not possible if pairing information registered for another camera remains on the smartphone. In this case, remove the camera's registration retained in the Bluetooth settings on the smartphone and try pairing again (📄).

### Wi-Fi functions cannot be set.

---

- If the camera is connected to a computer or another device with an interface cable, Wi-Fi functions cannot be set. Disconnect the interface cable before setting any functions (📄).

### A device connected with an interface cable cannot be used.

---

- Other devices, such as computers, cannot be used with the camera by connecting them with an interface cable while the camera is connected to devices via Wi-Fi. Terminate the Wi-Fi connection before connecting the interface cable.

### Operations such as shooting and playback are not possible.

---

- With a Wi-Fi connection established, operations such as shooting and playback may not be possible. Terminate the Wi-Fi connection, then perform the operation.

### Cannot reconnect to a smartphone.

---

- Even with a combination of the same camera and smartphone, if you have changed the settings or selected a different setting, reconnection may not be established even after selecting the same SSID. In this case, delete the camera connection settings from the Wi-Fi settings on the smartphone and set up a connection again.
- A connection may not be established if Camera Connect is running when you reconfigure connection settings. In this case, quit Camera Connect for a moment and then restart it.

## Operation problems

### Settings change when I switch from still photo shooting to movie recording or vice versa.

---

- Separate settings are retained for use when shooting still photos and recording movies.

### I cannot adjust settings with < >, < >, < >, < >, < >, or < >.

---

- Press the < LOCK > button to release the Multi-function lock (🔒).
- Check the [: Multi function lock] setting (🔗).



### Touch operation is not possible.

---

- Make sure [: Touch control] is set to [Standard] or [Sensitive] (🔗).

### A camera button or dial does not work as expected.

---

- In movie recording, check the [: Shutter btn function for movies] setting (🔗).
- Check the [: Customize buttons] and [: Customize dials] settings (🔗).

## Display problems

### The menu screen shows fewer tabs and items.

---

- In [A+] mode, some tabs and items are not displayed. Tabs and items on the menu screen also vary for still photos and movies.

### The display starts with [★] My Menu, or the [★] tab alone is displayed.

---

- [Menu display] on the [★] tab is set to [Display from My Menu tab] or [Display only My Menu tab]. Set [Normal display] (🔗).

### The file name's first character is an underscore (“\_”).

---

- Set [📷: Color space] to [sRGB]. If [Adobe RGB] is set, the first character will be an underscore (🔗).

### The fourth character in the file name changes.

---

- [📁: File name] is set to [\*\*\* + image size]. Select either the camera's unique file name or the file name registered in User setting 1 (🔗).

### The file numbering does not start from 0001.

---

- If the card already contains recorded images, the image number may not start from 0001 (🔗).

### The shooting date and time displayed are incorrect.

---

- Make sure the correct date and time are set (🔗).
- Check the time zone and daylight saving time (🔗).

### The date and time are not in the image.

---

- The shooting date and time do not appear in the image. The date and time are recorded in the image data as shooting information. When you print photos, this information can be used to include the date and time (🔗).

### [###] is displayed.

---

- If the number of images recorded on the card exceeds the number the camera can display, [###] will be displayed.

## **The screen does not display a clear image.**

---

- If the screen is dirty, use a soft cloth to clean it.
- The screen display may seem slightly slow in low temperatures or may look black in high temperatures, but it will return to normal at room temperature.



### Part of the image blinks in black.

---

- [▶]: **Highlight alert** is set to **[Enable]** (🔒).

### A red box is displayed on the image.

---

- [▶]: **AF point disp.** is set to **[Enable]** (🔒).

### During image playback, the AF points are not displayed.

---

- AF points are not displayed when the following types of images are played back:
  - Images taken with Multi Shot Noise Reduction applied.
  - Cropped images.
  - Images from HDR shooting with **[Auto Image Align]** set to **[Enable]**.

### The image cannot be erased.

---

- If the image is protected, it cannot be erased (🔒).

### Still photos and movies cannot be played back.

---

- The camera may not be able to play back images taken with another camera.
- Movies edited with a computer cannot be played back with the camera.

### Only few images can be played back.

---

- The images have been filtered for playback with [▶]: **Set image search conditions** (🔒). Clear the image search conditions.

### Mechanical sounds or sounds of camera operations can be heard during movie playback.

---

- The camera's built-in microphone may also record mechanical sounds of the lens or sounds of camera/lens operations if AF operations are performed or the camera or lens is operated during movie recording. In this case, using an external microphone may reduce these sounds. If the sounds are still distracting with an external microphone, it may be more effective to remove the external microphone from the camera and position it away from the camera and lens.

## Movie playback stops by itself.

---

- Extended movie playback or movie playback under high ambient temperature may cause the camera's internal temperature to rise, and movie playback may stop automatically.  
If this happens, playback is disabled until the camera's internal temperature decreases, so turn off the power and let the camera cool down a while.

## The movie appears to freeze momentarily.

---

- Significant change in the exposure level during autoexposure movie recording may cause recording to stop momentarily until the brightness stabilizes. In this case, record in [iA/M] mode (🔗).

## The movie is played in slow motion.

---

- High Frame Rate movies are recorded at 29.97 fps or 25.00 fps, so they are played in slow motion at 1/4 speed.

## No picture appears on the television.

---

- Make sure [🔧: Video system] is set to [For NTSC] or [For PAL] correctly for the video system of your television.
- Make sure the HDMI cable's plug is inserted all the way in (🔗).

## There are multiple movie files for a single movie recording.

---

- If the movie file size reaches 4 GB, another movie file will be created automatically (🔗). However, if you use an SDXC card formatted with the camera, you can record a movie in a single file even if it exceeds 4 GB.

## My card reader does not recognize the card.

---

- Depending on the card reader used and the computer's operating system, SDXC cards may not be correctly recognized. In this case, connect the camera to the computer with the interface cable, then import the images to the computer using EOS Utility (EOS software, 🔗).

## Images cannot be resized or cropped.

---

- This camera cannot resize JPEG **S2** images, RAW images, or frame-grab images from 8K or 4K movies saved as still photos (🔗).
- This camera cannot crop RAW images, images captured with **[HDR shooting HDR PQ]** in **[📷: HDR PQ settings]** set to **[Enable]**, or frame-grab images from 8K or 4K movies saved as still photos (🔗).

## Dots of light appear on the image.

---

- White, red, or blue dots of light may appear in captured images if the sensor is affected by cosmic rays or similar factors. Their appearance may be reduced by performing **[Clean now 🧹]** under **[🔧: Sensor cleaning]** (🔗).

### Sensor cleaning problems

## The shutter makes a sound during sensor cleaning.

---

- Although there is a mechanical sound from the shutter during cleaning after **[Clean now 🧹]** is selected, no image is recorded to the card (🔗).

## Automatic sensor cleaning does not work.

---

- Repeatedly turning the power switch **< ON >** and **< OFF >** within a short period may prevent the **[🧹]** icon from being displayed (🔗).

## Computer connection problems

### I cannot import images to a computer.

---

- Install EOS Utility (EOS software) on the computer (🔗).
- Make sure the main EOS Utility window is displayed.
- If the camera is already connected via Wi-Fi, it cannot communicate with any computer connected with an interface cable.
- Check the version of the application.

### Communication between the connected camera and computer does not work.

---

- When using EOS Utility (EOS software), set [📷: Time-lapse movie] to [Disable] (🔗).

## Error Codes

---

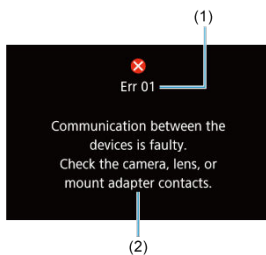

(1) Error number

(2) Cause and countermeasures

If there is a problem with the camera, an error message will appear. Follow the on-screen instructions.

If the problem persists, write down the error code (Errxx) and request service.

# System Map

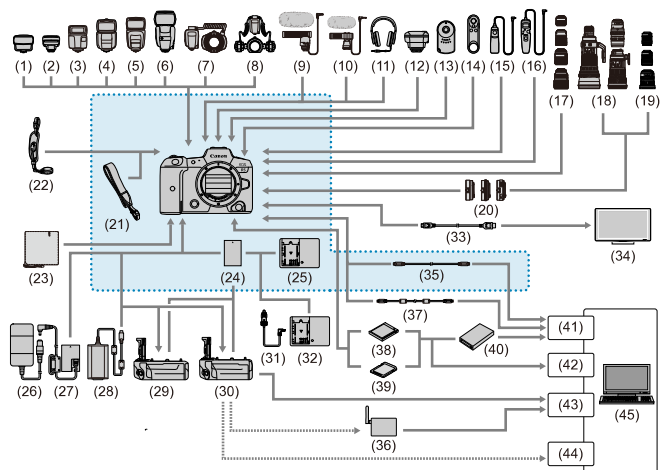

 Bundled accessories

(1)	Speedlite Transmitter ST-E2
(2)	Speedlite Transmitter ST-E3-RT
(3)	Speedlite EL-100
(4)	Speedlite 430EX III-RT/430EX III
(5)	Speedlite 470EX-AI
(6)	Speedlite 600EX II-RT
(7)	Macro Ring Lite MR-14EX II
(8)	Macro Twin Lite MT-26EX-RT
(9)	Directional Stereo Microphone DM-E1
(10)	Stereo Microphone DM-E100
(11)	Headphones
(12)	GPS Receiver GP-E2
(13)	Remote Controller RC-6
(14)	Wireless Remote Control BR-E1
(15)	Remote Switch RS-80N3
(16)	Timer Remote Controller TC-80N3
(17)	RF lenses
(18)	EF lenses
(19)	EF-S lenses
(20)	Mount Adapter
(21)	Strap
(22)	Hand Strap E2
(23)	Protecting Cloth PC-E1/E2
(24)	Battery Pack LP-E6NH <sup>1</sup>
(25)	Battery Charger LC-E6
(26)	AC Adapter AC-E6N <sup>2</sup>
(27)	DC Coupler DR-E6 <sup>2</sup>
(28)	USB Power Adapter PD-E1 <sup>3</sup>
(29)	Battery Grip BG-R10
(30)	Wireless File Transmitter WFT-R10
(31)	Car Battery Cable CB-570
(32)	Car Battery Charger CBC-E6
(33)	HDMI cable <sup>7</sup>
(34)	TV/monitor
(35)	Interface Cable IFC-100U (approx. 1 m/3.2 ft.) <sup>4, 5</sup>
(36)	Wireless LAN access point
(37)	Interface Cable IFC-400U (approx. 4 m/13.1 ft.) <sup>4, 6</sup>
(38)	CFexpress card
(39)	SD/SDHC/SDXC memory cards
(40)	Card reader
(41)	USB port

---

(42)	Card slot
(43)	Ethernet port
(44)	Wireless LAN adapter
(45)	Computer

---

\* 1: Battery Pack LP-E6N/LP-E6 can also be used.

\* 2: AC Adapter Kit ACK-E6 can also be used.

\* 3: Charging with USB Power Adapter PD-E1 is only available for LP-E6NH/LP-E6N (not LP-E6).

\* 4: Camera and computer end: USB Type-C.

\* 5: The transmission rate when IFC-100U is used is equivalent to SuperSpeed USB (USB 3.1 Gen 1).

\* 6: The transmission rate when IFC-400U is used is equivalent to Hi-Speed USB (USB 2.0).

\* 7: Use a cable no longer than 2.5 m (8.2 ft.). The camera end is Type D.



## ISO Speed in Movie Recording

---

### In [M<sup>A</sup>]/[M<sup>V</sup>]/[M<sup>V</sup>]/[M<sup>Av</sup>] mode

- ISO speed is set automatically in a range of ISO 100–25600.
- Setting [Max for Auto] in [CAMERA: ISO speed settings] to [H (51200)] (🔗) expands the maximum speed in the automatic setting range to H (equivalent to ISO 51200).
- The minimum speed in the automatic setting range is ISO 200 when [CAMERA: Highlight tone priority] is set to [Enable] or [Enhanced] (🔗). The maximum limit is not expanded, even when expansion is set in [Max for Auto].
- The minimum speed in the automatic setting range is ISO 400 when [CAMERA: Canon Log settings] is set to [On] (🔗).

### In [M<sup>M</sup>] mode

- With ISO speed set to [AUTO], ISO speed is set automatically in a range of ISO 100–25600.
- When ISO Auto is set, setting [Max for Auto] in [CAMERA: ISO speed settings] to [H (51200)] (🔗) expands the maximum speed in the automatic setting range to H (equivalent to ISO 51200).
- ISO speed can be set manually in a range of ISO 100–25600. Setting [ISO speed range] in [CAMERA: ISO speed settings] to [H (51200)] (🔗) expands the maximum speed in the manual setting range to H (equivalent to ISO 51200).
- The minimum speed in the automatic or manual setting range is ISO 200 when [CAMERA: Highlight tone priority] is set to [Enable] or [Enhanced] (🔗). Even when ISO speed expansion is set, the maximum limit will not be expanded.
- The minimum speed in the automatic setting range is ISO 400 when [CAMERA: Canon Log settings] is set to [On] (🔗). ISO 100–200 represents an expanded ISO speed (L).

# Information Display

---

- [LCD Panel](#)
- [Still Photo Shooting Screen](#)
- [Movie Recording Screen](#)
- [Scene Icons](#)
- [Playback Screen](#)

## LCD Panel

---

### Still photo/movie standby screen 1

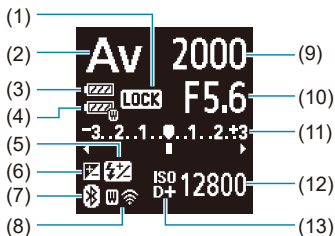

- |      |   |
|------|---|
| (1)  | Multi-function lock   |
| (2)  | Shooting mode   |
| (3)  | Battery level   |
| (4)  | WFT battery level   |
| (5)  | Flash exposure compensation                                     |
| (6)  | Exposure compensation   |
| (7)  | Bluetooth function  |
| (8)  | Wi-Fi function/WFT status (wireless)/WFT status (wired)         |
| (9)  | Shutter speed   |
| (10) | Aperture value  |
| (11) | Exposure level indicator/Exposure compensation amount/AEB range |
| (12) | ISO speed   |
| (13) | Highlight tone priority   |

## Still photo standby screen 2

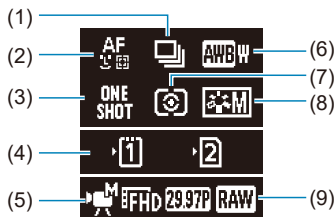

- |     |                         |
|-----|-------------------------|
| (1) | Drive mode              |
| (2) | AF method               |
| (3) | AF operation            |
| (4) | Card slot               |
| (5) | Movie recording mode    |
| (6) | White balance           |
| (7) | Metering mode           |
| (8) | Picture Style           |
| (9) | Movie recording quality |

## Movie standby screen 2

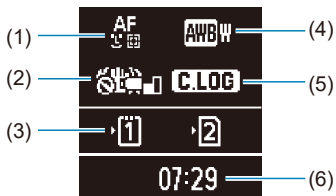

- 
- (1) AF method
- 
- (2) Image Stabilizer (IS mode)
- 
- (3) Card slot
- 
- (4) White balance
- 
- (5) Canon Log
- 
- (6) Movie recording time available
-

## Movie recording in progress



---

(1) Elapsed recording time

---

(2) Recording in progress/External recording in progress (10-bit, via HDMI)

---

## Still Photo Shooting Screen

Each time you press the <INFO> button, the information display will change.

- The display will show only the settings currently applied.

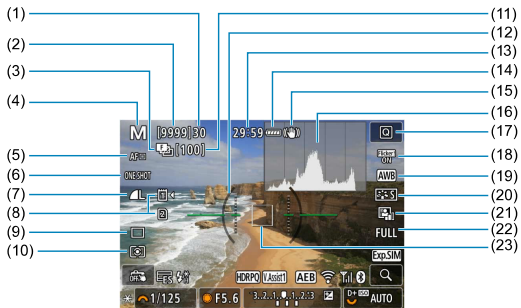

(1)	Maximum burst
(2)	Number of available shots/Sec. until self-timer shoots
(3)	Focus bracketing/HDR/Multiple exposures/Multi Shot Noise Reduction/Bulb timer/Interval timer
(4)	Shooting mode
(5)	AF method
(6)	AF operation
(7)	Image quality
(8)	Card
(9)	Drive mode
(10)	Metering mode
(11)	No. of remaining shots for focus bracketing, multiple exposures, or interval timer
(12)	Electronic level
(13)	Movie recording time available
(14)	Battery level
(15)	Image Stabilizer (IS mode)
(16)	Histogram (Brightness/RGB)
(17)	Quick Control button
(18)	Anti-flicker shooting
(19)	White balance/White balance correction
(20)	Picture Style
(21)	Auto Lighting Optimizer
(22)	Still photo cropping/Aspect ratio
(23)	AF point (1-point AF)

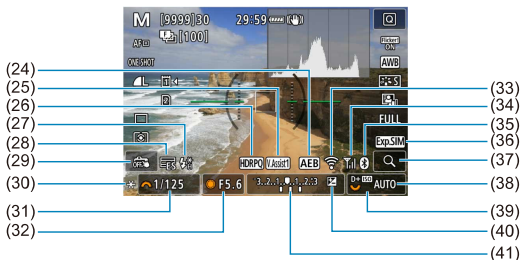

(24)	AEB/FEB
(25)	View Assist
(26)	HDR PQ
(27)	Flash ready/FE lock/High-speed sync
(28)	Electronic shutter
(29)	Touch Shutter/Create folder
(30)	AE lock
(31)	Shutter speed/Multi-function lock warning
(32)	Aperture value
(33)	Wi-Fi function
(34)	Wi-Fi signal strength
(35)	Bluetooth function
(36)	Exposure simulation
(37)	Magnify button
(38)	ISO speed
(39)	Highlight tone priority
(40)	Exposure compensation
(41)	Exposure level indicator

#### Note

- You can specify the information displayed in response to pressing the <INFO> button (📄).
- The electronic level is not displayed when the camera is connected via HDMI to a television.
- Other icons may be displayed temporarily after setting adjustments.



## Movie Recording Screen

Each time you press the <INFO> button, the information display will change.

- The display will show only the settings currently applied.

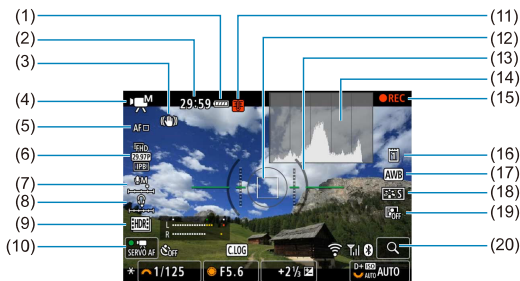

- |      |   |
|------|---|
| (1)  | Battery level   |
| (2)  | Movie recording time available/Elapsed recording time |
| (3)  | Image Stabilizer (IS mode)                            |
| (4)  | Shooting mode   |
| (5)  | AF method   |
| (6)  | Movie recording size                                  |
| (7)  | Audio recording level (manual/line input)             |
| (8)  | Headphone volume                                      |
| (9)  | HDR movie   |
| (10) | Movie Servo AF  |
| (11) | Temperature warning                                   |
| (12) | AF point (1-point AF)                                 |
| (13) | Electronic level                                      |
| (14) | Histogram (Brightness/RGB)                            |
| (15) | Movie recording in progress                           |
| (16) | Card for recording/playback                           |
| (17) | White balance/White balance correction                |
| (18) | Picture Style   |
| (19) | Auto Lighting Optimizer                               |
| (20) | Magnify button  |

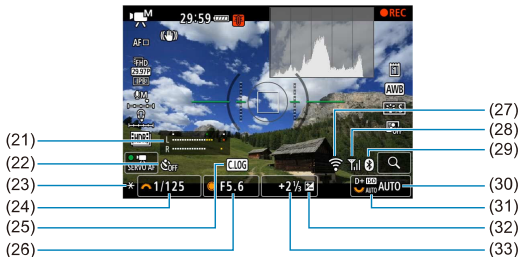

(21) Audio recording level indicator (manual/line input)

(22) Movie self-timer

(23) AE lock

(24) Shutter speed

(25) Canon Log

(26) Aperture value

(27) Wi-Fi function

(28) Wi-Fi signal strength

(29) Bluetooth function

(30) ISO speed

(31) Highlight tone priority

(32) Exposure compensation

(33) Exposure level indicator (metering levels)

### Caution

- You can specify the information displayed in response to pressing the <INFO> button (🔍).
- The electronic level is not displayed when the camera is connected via HDMI to a television.
- The electronic level, grid lines, and histogram cannot be displayed during movie recording (and if they are currently displayed, recording a movie will clear the display).
- Time available per recording changes to elapsed time after movie recording begins.

### Note

- Other icons may be displayed temporarily after setting adjustments.

## Scene Icons

In [A+] shooting mode or [A+] recording mode, the camera detects the type of scene and sets all settings accordingly. The detected scene type is indicated in the upper left of the screen.

Subject Background	People <sup>*1</sup>		Subjects Other Than People			Background Color
		In Motion <sup>*2</sup>	Nature/ Outdoor Scene	In Motion <sup>*2</sup>	Close <sup>*3</sup>	
Bright						Gray
Backlit						
Blue Sky Included						Light blue
Backlit						
Sunset	*4				*4	Orange
Spotlight						Dark blue
Dark						
With Tripod <sup>*1</sup>		*4		*4		

\* 1: An icon for subjects other than people/animals is displayed in time-lapse movie recording.

\* 2: Not displayed during movie recording.

\* 3: Displayed when the attached lens has distance information. With an extension tube or close-up lens, the icon displayed may not match the actual scene.

\* 4: Icons of scenes selected from those that can be detected are displayed.

\* 5: Displayed when all the following conditions apply.

The shooting scene is dark, it is a night scene, and the camera is mounted on a tripod.

\* 6: Displayed with any of the following lenses.

- EF300mm f/2.8L IS II USM
- EF400mm f/2.8L IS II USM
- EF500mm f/4L IS II USM
- EF600mm f/4L IS II USM
- Image Stabilizer lenses released in and after 2012.

\* Slower shutter speeds are used when the conditions in both \*5 and \*6 apply.

### Note

- For certain scenes or shooting conditions, the icon displayed may not match the actual scene.

## Playback Screen

### Basic information display for still photos

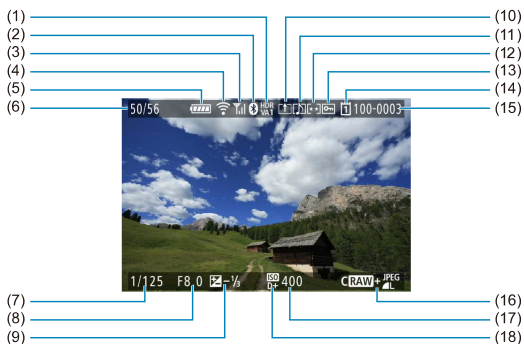

- |      |  |
|------|--|
| (1)  | HDR output status/View Assist                      |
| (2)  | Bluetooth function                                 |
| (3)  | Wi-Fi signal strength                              |
| (4)  | Wi-Fi function                                     |
| (5)  | Battery level                                      |
| (6)  | Current image no./Total images/No. of images found |
| (7)  | Shutter speed                                      |
| (8)  | Aperture value                                     |
| (9)  | Exposure compensation amount                       |
| (10) | Already sent to a computer/smartphone              |
| (11) | Voice memo   |
| (12) | Rating   |
| (13) | Image protection                                   |
| (14) | Card no.   |
| (15) | Folder no.-File no.                                |
| (16) | Image quality/Edited image/Cropping/Frame Grab     |
| (17) | ISO speed  |
| (18) | Highlight tone priority                            |

 **Caution**

- If the image was taken by another camera, certain shooting information may not be displayed.
- It may not be possible to play back images taken with this camera on other cameras.

## Detailed information display for still photos

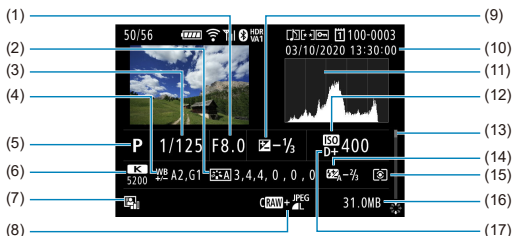

(1)	Aperture value
(2)	Picture Style/Settings
(3)	Shutter speed
(4)	White balance correction/Bracketing
(5)	Shooting mode/Multiple exposure/Frame Grab
(6)	White balance
(7)	Auto Lighting Optimizer
(8)	Image quality/Edited image/Cropping
(9)	Exposure compensation amount
(10)	Shooting date and time
(11)	Histogram (Brightness/RGB)
(12)	ISO speed
(13)	Scroll bar
(14)	Flash exposure compensation amount/Bounce/HDR shooting/Multi Shot Noise Reduction
(15)	Metering mode
(16)	File size
(17)	Highlight tone priority

\* For images captured in RAW+JPEG/HEIF shooting, indicates RAW file sizes.

\* Lines indicating the image area will be displayed for images taken with the aspect ratio set (⊗) and with RAW or RAW+JPEG set for image quality.

\* For images with added cropping information, lines are shown to indicate the image area.

\* During flash photography without flash exposure compensation, (⚡) will be displayed.

\* (⚡) indicates images shot with bounce flash photography.

\* An icon for the effect (⊗) and the dynamic range adjustment amount is displayed for images captured in HDR shooting.

\* (M) indicates images captured in multiple-exposure shooting.

\* (NR) indicates images processed with Multi Shot Noise Reduction.

\* (L) indicates test shots for time-lapse movies.

\* (C) indicates images created and saved by performing RAW image processing, resizing, cropping, or frame-grabbing.

\* (C) indicates images cropped and then saved.

## Detailed information display for movies

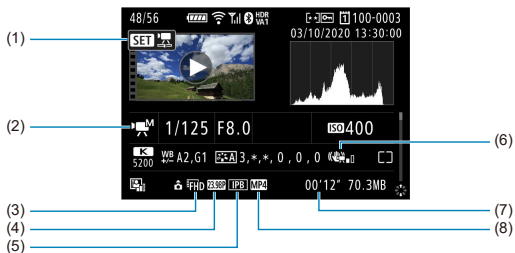

- |     |   |
|-----|---|
| (1) | Movie playback                            |
| (2) | Movie recording mode/High Frame Rate mode |
| (3) | Image size                                |
| (4) | Frame rate                                |
| (5) | Compression method                        |
| (6) | Image Stabilizer (IS mode)                |
| (7) | Recording time/Time code                  |
| (8) | Movie recording format                    |

\* For simplicity, explanations are omitted for items that are also included in basic/detailed information display for still photos, which are not shown here.

### Note

- During movie playback, “\* , \*” is displayed for the [Fineness] and [Threshold] parameters of [Sharpness] in [Picture Style].

## EF Lenses Supporting 12 Shots/Sec. Continuous Shooting

---

The following EF lenses support 12 shots/sec. continuous shooting in [AF] drive mode.

EF24mm f/2.8 IS USM
EF28mm f/2.8 IS USM
EF35mm f/1.4L II USM
EF35mm f/2 IS USM
EF40mm f/2.8 STM
EF50mm f/1.8 STM
EF85mm f/1.4L IS USM
EF200mm f/2.8L II USM
EF300mm f/2.8L IS II USM
EF400mm f/2.8L IS III USM
EF500mm f/4L IS II USM
EF600mm f/4L IS II USM
EF600mm f/4L IS III USM
EF8-15mm f/4L Fisheye USM
EF11-24mm f/4L USM
EF16-35mm f/2.8L III USM
EF16-35mm f/4L IS USM
EF24-70mm f/2.8L II USM
EF24-70mm f/4L IS USM
EF24-105mm f/4L IS II USM
EF24-105mm f/3.5-5.6 IS STM
EF70-200mm f/2.8L IS III USM
EF70-200mm f/4L IS USM
EF70-200mm f/4L IS II USM
EF70-300mm f/4-5.6L IS USM
EF70-300mm f/4-5.6 IS II USM
EF100-400mm f/4.5-5.6L IS II USM
EF200-400mm f/4L IS USM Extender 1.4X



EF-S24mm f/2.8 STM
EF-S35mm f/2.8
EF-S10-18mm f/4.5-5.6 IS STM
EF-S15-85mm f/3.5-5.6 IS USM
EF-S18-55mm f/3.5-5.6 IS STM
EF-S18-55mm f/4-5.6 IS STM
EF-S18-135mm f/3.5-5.6 IS USM
EF-S18-135mm f/3.5-5.6 IS STM
EF-S55-250mm f/4-5.6 IS STM

# Specifications

---

## Type

**Type:** Digital single-lens non-reflex AF/AE camera

**Lens mount:** Canon RF mount

**Compatible lenses:** Canon RF lens group

\* Using mount adapter EF-EOS R: Canon EF or EF-S lenses (excluding EF-M lenses)

**Lens focal length:** Same as the focal length indicated on the lens

\* Using EF-S lenses: Approx. 1.6 times the indicated focal length

## Image sensor

**Type:** CMOS sensor

Screen size	Approx. 36.0×24.0 mm
Effective pixels <sup>*1,2</sup>	Max. approx. 45.0 megapixels
Dual Pixel CMOS AF	Supported

\* 1: Rounded to the nearest 100,000.

\* 2: Using RF or EF lenses. The effective pixel count may be lower with certain lenses and image processing.

## Recording system

**Image recording format:** Compliant to Design rule for Camera File system 2.0 and Exif 2.31\*

\* Supports time difference information

## Image type and extension

Image type		Extension
Still photos	JPEG	JPG
	HEIF	HIF
	RAW	CR3
	Dual Pixel RAW	
	C-RAW	
Movies	ALL-I, IPB	MP4
	RAW	CRM

## Still photo recording

### Still photo pixel count

























Image quality		Recorded pixels				
		Aspect ratio				
		3:2	1.6x (crop) <sup>1</sup>	1:1	4:3	16:9
JPEG HEIF	<b>L</b>	Approx. 44.8 megapixels (8192×5464)	Approx. 17.3 megapixels (5088×3392)	Approx. 29.8 megapixels (5456×5456)	Approx. 39.8 megapixels (7280×5464)	Approx. 37.7 megapixels (8192×4608)
	<b>M</b>	Approx. 22.5 megapixels (5808×3872)		Approx. 15.0 megapixels (3872×3872)	Approx. 19.9 megapixels (5152×3872)	Approx. 19.0 megapixels (5808×3264)
	<b>S1</b>	Approx. 11.6 megapixels (4176×2784)		Approx. 7.8 megapixels (2784×2784)	Approx. 10.3 megapixels (3712×2784)	Approx. 9.8 megapixels (4176×2344)
	<b>S2</b>	Approx. 3.8 megapixels (2400×1600)	Approx. 3.8 megapixels (2400×1600)	Approx. 2.6 megapixels (1600×1600)	Approx. 3.4 megapixels (2112×1600)	Approx. 3.2 megapixels (2400×1344)
RAW	<b>RAW / CRRAW</b>	Approx. 44.8 megapixels (8192×5464)	Approx. 17.3 megapixels (5088×3392)	Approx. 44.8 megapixels (8192×5464)		

\* Values for recorded pixels are rounded off to the nearest 100,000th.

\* RAW images are generated at 3:2, with information added about the specified aspect ratio, and JPEG images are generated at the specified aspect ratio.

\* 1: Angle of view of approx. 1.6 times the focal length.

## Still photo file size / Number of possible shots / Maximum burst for continuous shooting

	Image quality	File size [Approx. MB]	Possible shots [Approx.] <sup>*1</sup>	Maximum burst [Approx.] <sup>*5</sup>		
				SD card <sup>*1</sup>	SD card <sup>*1</sup> [Hi-speed]	CFexpress card <sup>*2</sup>
JPEG <sup>*4</sup>	 L	13.5	2240	190	350	350
	 L	6.8	4450	260		350
	 M	7.8	3860	320		350
	 M	4.1	7330	290		350
	 S1	4.7	6420	330		350
	 S1	2.6	11360	330		350
	 S2	1.8	16790	340		350
HEIF <sup>*3</sup>	 L	13.4	2240	190	280	280
	 L	10.0	2970	210		330
	 M	8.3	3580	310		310
	 M	6.3	4730	350		360
	 S1	5.1	5710	340		360
	 S1	4.0	7330	360		350
	 S2	1.8	14480	340		360
RAW <sup>*4</sup>	 RAW	45.4	670	66	87	180
	 CRAW	21.9	1440	130	260	260
RAW+JPEG <sup>*4</sup>	 RAW +  L	45.4+13.5	520	64	79	160
	 CRAW +  L	21.9+13.5	870	100	130	240
RAW+HEIF <sup>*3</sup>	 RAW +  L	45.4+13.4	480	61	74	90
	 CRAW +  L	21.9+13.4	780	110	140	140

\* 1: The number of possible shots and maximum burst (SD card) apply to a UHS-I compliant 32 GB SD card based on Canon testing standards. The number of possible shots and maximum burst (SD card [Hi-speed]) apply to a UHS-II compliant 32 GB SD card based on Canon testing standards.

\* 2: The number of shots available and maximum burst (CFexpress card) apply to a 325 GB CFexpress card conforming to Canon testing standards.

\* 3: Available when [HDR PQ] for HDR shooting is set to [Enable].

\* 4: When [HDR PQ] for HDR shooting is set to [Disable].

\* 5: With mechanical shutter or electronic 1st-curtain shutter, shot at approx. 12 fps.

\* File size, number of possible shots, and maximum burst vary depending on shooting conditions (including 1.6x crop/aspect ratio, subject, memory card brand, ISO speed, Picture Style, and Custom Function).

## Movie recording

Movie recording format: MP4, RAW

### Estimated recording time, movie bit rate, and file size

Canon Log: Off, HDR PQ: Off

Movie recording size			Total recording time (Approx.)			Movie bit rate (Approx. Mbps)	File size (Approx. MB/min.)	
			64 GB	256 GB	1 TB			
8K DCI	29.97 fps 25.00 fps 24.00 fps 23.98 fps	RAW	3 min.	13 min.	51 min.	2600	18668	
		ALL-I	6 min.	26 min.	1 hr. 42 min.	1300	9309	
		IPB	18 min.	1 hr. 12 min.	4 hr. 42 min.	470	3373	
8K UHD	29.97 fps 25.00 fps 23.98 fps	ALL-I	6 min.	26 min.	1 hr. 42 min.	1300	9309	
		IPB	18 min.	1 hr. 12 min.	4 hr. 42 min.	470	3373	
4K DCI	59.94 fps 50.00 fps	ALL-I	9 min.	36 min.	2 hr. 21 min.	940	6734	
		IPB	36 min.	2 hr. 27 min.	9 hr. 35 min.	230	1656	
4K DCI 4K DCI Fine	29.97 fps 25.00 fps 24.00 fps 23.98 fps	ALL-I	18 min.	1 hr. 12 min.	4 hr. 42 min.	470	3373	
		IPB	1 hr. 10 min.	4 hr. 40 min.	18 hr. 17 min.	120	869	
4K DCI	119.88 fps 100.00 fps	ALL-I	4 min.	18 min.	1 hr. 10 min.	1880	13447	
4K UHD	59.94 fps 50.00 fps	ALL-I	9 min.	36 min.	2 hr. 21 min.	940	6734	
		IPB	36 min.	2 hr. 27 min.	9 hr. 35 min.	230	1656	
4K UHD 4K UHD Fine	29.97 fps 25.00 fps 23.98 fps	ALL-I	18 min.	1 hr. 12 min.	4 hr. 42 min.	470	3373	
		IPB	1 hr. 10 min.	4 hr. 40 min.	18 hr. 17 min.	120	869	
4K UHD	119.88 fps 100.00 fps	ALL-I	4 min.	18 min.	1 hr. 10 min.	1880	13447	
Full HD	59.94 fps 50.00 fps	ALL-I	47 min.	3 hr. 8 min.	12 hr. 14 min.	180	1298	
		IPB	2 hr. 18 min.	9 hr. 14 min.	36 hr. 6 min.	60	440	
	29.97 fps 25.00 fps 23.98 fps	ALL-I	1 hr. 33 min.	6 hr. 12 min.	24 hr. 16 min.	90	655	
		IPB	4 hr. 30 min.	18 hr. 2 min.	70 hr. 27 min.	30	226	
29.97 fps 25.00 fps	IPB (Light)	11 hr. 35 min.	46 hr. 23 min.	181 hr. 13 min.	12	88		
Time-lapse movies	8K	29.97 fps 25.00 fps	ALL-I	6 min.	26 min.	1 hr. 42 min.	1300	9298
	4K			18 min.	1 hr. 12 min.	4 hr. 43 min.	470	3362
	Full HD			1 hr. 34 min.	6 hr. 19 min.	24 hr. 41 min.	90	644

Canon Log: On or HDR PQ: On

Movie recording size			Total recording time (Approx.)			Movie bit rate (Approx. Mbps)	File size (Approx. MB/min.)	
			64 GB	256 GB	1 TB			
8K DCI	29.97 fps 25.00 fps 24.00 fps 23.98 fps	RAW	3 min.	13 min.	51 min.	2600	18668	
		ALL-I	6 min.	26 min.	1 hr. 42 min.	1300	9309	
		IPB	12 min.	50 min.	3 hr. 15 min.	680	4875	
8K UHD	29.97 fps 25.00 fps 23.98 fps	ALL-I	6 min.	26 min.	1 hr. 42 min.	1300	9309	
		IPB	12 min.	50 min.	3 hr. 15 min.	680	4875	
4K DCI	59.94 fps 50.00 fps	ALL-I	8 min.	34 min.	2 hr. 13 min.	1000	7164	
		IPB	24 min.	1 hr. 39 min.	6 hr. 30 min.	340	2443	
4K DCI 4K DCI Fine	29.97 fps 25.00 fps 24.00 fps 23.98 fps	ALL-I	18 min.	1 hr. 12 min.	4 hr. 42 min.	470	3373	
		IPB	49 min.	3 hr. 18 min.	12 hr. 57 min.	170	1227	
4K DCI	119.88 fps 100.00 fps	ALL-I	4 min.	18 min.	1 hr. 10 min.	1880	13447	
4K UHD	59.94 fps 50.00 fps	ALL-I	8 min.	34 min.	2 hr. 13 min.	1000	7164	
		IPB	24 min.	1 hr. 39 min.	6 hr. 30 min.	340	2443	
4K UHD 4K UHD Fine	29.97 fps 25.00 fps 23.98 fps	ALL-I	18 min.	1 hr. 12 min.	4 hr. 42 min.	470	3373	
		IPB	49 min.	3 hr. 18 min.	12 hr. 57 min.	170	1227	
4K UHD	119.88 fps 100.00 fps	ALL-I	4 min.	18 min.	1 hr. 10 min.	1880	13447	
Full HD	59.94 fps 50.00 fps	ALL-I	36 min.	2 hr. 27 min.	9 hr. 35 min.	230	1656	
		IPB	1 hr. 33 min.	6 hr. 12 min.	24 hr. 16 min.	90	655	
	29.97 fps 25.00 fps 23.98 fps	ALL-I	1 hr. 2 min.	4 hr. 9 min.	16 hr. 16 min.	135	977	
		IPB	3 hr. 3 min.	12 hr. 13 min.	47 hr. 45 min.	45	333	
29.97 fps 25.00 fps	IPB (Light)	5 hr. 1 min.	20 hr. 7 min.	78 hr. 37 min.	28	202		
Time-lapse movies	8K	29.97 fps 25.00 fps	ALL-I	6 min.	26 min.	1 hr. 42 min.	1300	9298
	4K			18 min.	1 hr. 12 min.	4 hr. 43 min.	470	3362
	Full HD			1 hr. 3 min.	4 hr. 12 min.	16 hr. 27 min.	135	966

\* Bit rate indicates video output only, audio is not included.

\* Movie recording is interrupted if the maximum recording time per movie, 29 min. 59 sec., is exceeded.

(Time is different for High Frame Rate movies.)

\* 8K movie recording (RAW, DCI, UHD) has restrictions on possible recording time due to the temperature rise. Max possible recording time is approx. 20 min. (at room temperature).

\* 4K 60 p movie cropped recording has restrictions on possible recording time due to the temperature rise. Max possible recording time is approx. 25 min. (at room temperature).

\* Sound is not recorded for approx. the last two frames when the compression method for movie recording quality is IPB or IPB Light (audio: AAC) or  : **Audio compression** is set to **[Enable]**. Moreover, the video and sound may be slightly out of sync when movies are played back in Windows.

## Card performance requirements (Movie recording) [Write/read speed]

	Movie recording size		CFexpress card	SD card	
			8bit / 10bit	8 bit	10 bit
8K	8K RAW	RAW	Refer to the Canon website	—	
	8K	ALL-I		—	
		IPB		Video Speed Class 60 or higher	Video Speed Class 90 or higher
4K	119.88 fps 100.00 fps	ALL-I		—	
	59.94 fps 50.00 fps	ALL-I		—	
		IPB		Video Speed Class 30 or higher	Video Speed Class 60 or higher
	Other than above	ALL-I		Video Speed Class 60 or higher	Video Speed Class 60 or higher
		IPB		UHS Speed Class 3 or higher	UHS Speed Class 3 or higher
Full HD	59.94 fps 50.00 fps	ALL-I		UHS Speed Class 3 or higher	UHS Speed Class 3 or higher
		IPB		SD Speed Class 10 or higher	UHS Speed Class 3 or higher
	Other than above	ALL-I		UHS Speed Class 3 or higher	UHS Speed Class 3 or higher
		IPB		SD Speed Class 6 or higher	SD Speed Class 6 or higher
		IPB (Light)	SD Speed Class 4 or higher	SD Speed Class 4 or higher	
Time-lapse movies	8K	ALL-I	—		
	4K		Video Speed Class 60 or higher	Video Speed Class 60 or higher	
	Full HD		UHS Speed Class 3 or higher	UHS Speed Class 3 or higher	

\* With Movie cropping set to [Disable], Movie digital IS set to [Off].



## Built-in and external microphones

Built-in microphone: Monaural microphone

External microphone: 3.5 mm diameter stereo mini jack

## Recording media

### Recording media:

CFexpress card

SD card

\* Compatible with UHS-II

## Viewfinder

**Type:** OLED color electronic viewfinder

**Screen size:** 0.5 inch

**Dot count:** Approx. 5,760,000 dots

**Magnification / angle of view:** Approx. 0.76× / Approx. 35.5° (with 50 mm lens at infinity, – 1 m<sup>-1</sup>)

**Coverage:** Approx. 100% (at L image quality, an aspect ratio of 3:2, and approx. 23 mm eyepoint)

**Eyepoint:** Approx. 23 mm (at –1 m<sup>-1</sup> from eyepiece lens end)

**Dioptric adjustment:** Approx. –4.0 to +2.0 m<sup>-1</sup> (dpt)

## Screen

**Type:** TFT color, liquid-crystal monitor

**Screen size:** 3.2 inch (Screen aspect ratio of 3:2)

**Dot count:** Approx. 2,100,000 dots

**Angle of view:** Approx. 170° vertically and horizontally

**Coverage:** Approx. 100% vertically and horizontally (at L image quality and an aspect ratio of 3:2)

**Brightness adjustment:** Possible (7 levels)

**Color tone adjustment:** Warm tone / Standard / Cool tone 1 / Cool tone 2

**Touch-screen:** Capacitive sensing

## LCD panel

**Type:** Reflective memory LCD

**Display format:** Dot-matrix display

**Dot count:** 128×128 dots

## HDMI output

**HDMI video / audio output:** HDMI micro OUT terminal (Type D) / CEC not supported

**HDMI output resolution:** Auto / 1080p

\* HDMI output of 8K movies not supported.

## Autofocus

**Focusing method:** Dual Pixel CMOS AF

### Focusing operation

	Still photo shooting	Movie recording
AF operation	One-Shot AF Servo AF (AI Focus AF) * Set automatically in A+ mode	One-Shot AF Movie Servo AF
Manual focus	Supported	Supported

**Lens compatibility based on AF area:** Refer to the Canon website

### Number of AF zones available for automatic selection

AF area		Horizontal: Approx. 100%, Vertical: Approx. 100%
Number of AF zone	Still photos	Max. 1053 zones (39×27)
	Movies	Max. 819 zones (39×21)

\* May vary depending on settings.

### Selectable positions for AF point

AF area		Horizontal: Approx. 90%, Vertical: Approx. 100%
Number of positions	Still photos	Max. 5940 positions (90×66)
	Movies	Max. 4500 positions (90×50)

\* When selected using the Multi-controller.

**Focusing brightness range (in still photo shooting):** EV –6 to 20 (With an f/1.2 lens\*, center AF point, One-Shot AF, at 23°C / 73°F, ISO 100)

\* Except RF lenses with a Defocus Smoothing (DS) coating

### Focusing brightness range (in movie recording)

8K	EV –3 to 20	* With an f/1.2 lens, center AF point, One-Shot AF, at 23°C / 73°F, ISO 100. * Except RF lenses with a Defocus Smoothing (DS) coating.
4K/Full HD	EV –4 to 20	

## Exposure control

### Metering functions under various shooting conditions

Item		Still photo shooting	Movie recording
Metering sensor		384 zone (24×16) metering using image sensor output signals	
Metering mode	Evaluative metering	Yes	Yes * When faces are detected with [L] +Tracking]
	Partial metering	Yes: (Approx. 6.1%) of the screen	
	Spot metering	Yes: (Approx. 3.1%) of the screen	
	Center-weighted average	Yes	Yes * When no faces are detected
Metering brightness range (At 23°C / 73°F, ISO 100)		EV -3 to 20	EV -1 to 20

### ISO speed (recommended exposure index) in still photo shooting

Manually set ISO speed in still photo shooting

Normal ISO speed	ISO 100–51200 (in 1/3-stop, 1-stop increments)
Expanded ISO speed (equivalent)	L (50) H (102400)

\* For [📷]: **Highlight tone priority**, the available ISO speed range is ISO 200 to 51200.

\* Expanded ISO cannot be set for HDR mode or during HDR PQ shooting.

### ISO speed range settings in still photo shooting

ISO speed range	ISO speed
Minimum	L (50)–51200 (in 1-stop increments)
Maximum	ISO 100–H (102400) (in 1-stop increments)

\* Expanded ISO speeds are noted as being "equivalent" to these speeds.

### ISO Auto range settings in still photo shooting

Auto range	ISO speed
Minimum	ISO 100–25600 (in 1-stop increments)
Maximum	ISO 200–51200 (in 1-stop increments)

## ISO Auto details in still photo shooting

Shooting mode	No flash	Using flash
 <b>A<sup>+</sup></b>	ISO 100–12800	ISO 100–6400 <sup>3</sup>
<b>P</b>	ISO 100 <sup>1</sup> 2–51200 <sup>2</sup>	ISO 100 <sup>1</sup> 2–6400 <sup>2</sup> 3
<b>Tv</b>		
<b>Av</b>		
<b>M</b>		
<b>B</b>	ISO 400 <sup>4</sup>	ISO 400 <sup>4</sup>

\* 1: ISO 200 when  : **Highlight tone priority** is set to [Enable] or [Enhanced].

\* 2: Varies depending on [Maximum] and [Minimum] of [Auto range].

\* 3: ISO 1600 when using a lens that is not compatible with "Variable control of maximum ISO Auto limit for E-TTL".

\* 4: If outside the setting range, changed to the value most close to ISO 400.

Variable control of maximum ISO Auto limit for E-TTL: Supported

## ISO speed for movie recording

Manually set ISO speed in movie recording

Normal ISO speed	ISO 100–25600 (in 1/3-stop, 1-stop increments)
Expanded ISO speed (equivalent)	H (51200)

\* For  : **Highlight tone priority**, the available ISO speed range is ISO 200 to 25600.

\* Expanded ISO cannot be set during RAW movie recording.

\* Cannot be manually set below ISO 400 for RAW movies when Canon Log is specified.

\* Expanded ISO cannot be set during HDR PQ movie recording.

\* Cannot be manually set above ISO 12800 for High Frame Rate movies.

## ISO speed range settings in movie recording

ISO speed range	ISO speed
Minimum	ISO 100–25600 (in 1-stop increments)
Maximum	ISO 100–H (51200) (in 1-stop increments)

\* Expanded ISO speeds are noted as being "equivalent" to these speeds.

## ISO Auto range settings in movie recording

Item	ISO speed
Max for Auto	ISO 6400–H (51200)
(Time-lapse movie) Max for Auto	ISO 400–25600

\* Expanded ISO speeds are noted as being "equivalent" to these speeds.

## Shutter

### Still photo shooting

Type: Electronically controlled focal-plane shutter

Shutter mode

Mechanical shutter
Electronic 1st curtain
Electronic shutter

### Shutter speed

When [Mechanical] or [Elec. 1st-curtain] is set	1/8000–30 sec., Bulb
When [Electronic] is set	1/8000–0.5 sec.

### X-sync speed

Mechanical shutter	1/200 sec.
Elec. 1st-curtain	1/250 sec.

### Movie recording

Type: Rolling shutter, using the image sensor

Shutter speed:

1/4000–1/25\* sec.

\* Varies by frame rate. For details, see exposure control details.

Movies with manual exposure / Tv mode recording: 1/4000–1/8\* sec.

\* Varies by shooting mode and frame rate.

\* 1/125 sec. (NTSC) or 1/100 sec. (PAL) with [High Frame Rate] set to [Enable].

## Image stabilization (IS mode): Provided

## External flash

**Sync contacts:** Hot shoe: X-sync contact

\* Max. flash sync speed: 1/250 sec. with elec. 1st-curtain, 1/200 sec. with mechanical shutter.

## Drive

### Drive mode and continuous shooting speed

Drive modes	Mechanical shutter	Electronic 1st curtain	Electronic shutter
Single shooting	Yes	Yes	Yes
High-speed continuous shooting+	Max. approx. 12 shots/sec.		Max. approx. 20 shots/ sec. * Lenses other than EF-S lenses
High-speed continuous shooting	Max. approx. 6.0 shots/ sec.	Max. approx. 8.0 shots/ sec.	
Low-speed continuous shooting	Max. approx. 3.0 shots/sec.		
Self-timer:10 sec / remote control	Yes		
Self-timer:2 sec / remote control	Yes		

## Playback

Item	Still photo	Movie
Magnify zoom display	1.5x–10x (15 levels)	
AF point display	Yes	
Grid display	Off / 3×3 / 6×4 / 3×3+diag	
Rating	OFF / ★ to ★★★★★ Select images / Select range / All images in folder / All images on card / All found images	
Image search	Search conditions Rating / Date / Folder / Protect / Type of file	
Protect	Select images / Select range / All images in folder / Unprotect all images in folder / All images on card / Unprotect all images on card / All found images	
In-camera RAW image processing	Supported	
Resizing	Supported	
Cropping	Supported	

## Frame grab from 8K / 4K movies

Individual frames in 8K / 4K movies recorded with the camera can be saved as JPEG still photos\*1.

8K	DCI	Approx. 35.4 megapixels (8192×4320)
	UHD	Approx. 33.2 megapixels (7680×4320)
4K	DCI	Approx. 8.8 megapixels (4096×2160)
	UHD	Approx. 8.3 megapixels (3840×2160)

\* 1: From HDR PQ movies, saved in HEIF format.

\* Extracted still photos cannot be resized or cropped within the camera.

\* Frame grab is not available for movies recorded with [Canon Log] set to [On].

## Print order (DPOF): Compliant with DPOF Version 1.1

### Customization (C.Fn)

**Custom Function:** 22 Custom Functions are settable

### External interface

#### Digital terminal

Terminal type: USB Type-C

Transmission: SuperSpeed Plus USB (USB 3.1 Gen 2) equivalent

Applications:

For computer communication

For in-camera charging / powering the camera with USB Power Adapter PD-E1

**HDMI output terminal:** HDMI micro OUT terminal (Type D)

**External microphone input terminal:** Compatible with the 3.5 mm diameter stereo mini plug

**Headphone terminal:** Compatible with the 3.5 mm diameter stereo mini plug

**Remote control terminal:** N3 type terminal

## Power source

### Battery

Compatible battery packs	LP-E6NH/LP-E6N/LP-E6
Quantity used	1

**USB battery charging and camera power:** Using USB Power Adapter PD-E1

### AC power source

AC adapter	AC-E6N
DC coupler	DR-E6

### Possible shots

Configuration	Shooting method	Battery	Temperature	Battery life (Approx. number of shots)	
				Smooth	Power saving
Camera body only	Screen	LP-E6NH	23°C / 73°F	320	490
			0°C / 32°F	310	470
	Viewfinder		23°C / 73°F	220	320
			0°C / 32°F	200	310
Eco mode (Screen)	23°C / 73°F	550	700		
Battery grip BG-R10 used	Screen	Two LP-E6NH batteries	23°C / 73°F	—	970
		One LP-E6NH battery	23°C / 73°F	—	480
	Viewfinder	Two LP-E6NH batteries	23°C / 73°F	—	640
Wireless File Transmitter WFT-R10 used	Screen	One LP-E6NH battery <sup>*1</sup>	23°C / 73°F	—	480
	Viewfinder	One LP-E6NH battery <sup>*1</sup>	23°C / 73°F	—	310

\* With fully charged batteries

\* 1: Used as a battery for the camera



## Available operating time

Conditions of use		Temperature	Available operating time
Time available for bulb exposure		23°C / 73°F	Approx. 4 hr. 40 min.
Time available for Live View shooting		23°C / 73°F	Approx. 3 hr. 50 min.
Time available for movie recording * Movie Servo AF: Disable	8K RAW movies (29.97 fps)		23°C / 73°F
			0°C / 32°F
	8K DCI	IPB (Standard) 29.97 fps / 25.00 fps	23°C / 73°F
	Full HD		23°C / 73°F
			0°C / 32°F
Time available for Time-lapse movie shooting	Full HD, shooting interval: 5 sec.	Screen: On	23°C / 73°F
		Screen: Off	23°C / 73°F
Time available for continuous playback	Movies (Normal playback)		23°C / 73°F

\* With a fully charged LP-E6NH

## Battery information

Remaining capacity	In 1% increments 5-level indicator
Number of shots	Supported
Recharge performance	3 levels
Battery registrations	Supported (up to 6)
Battery information	Serial number, remaining capacity when removed, date

## Dimensions and weight

### Dimensions

(W)×(H)×(D)	Approx. 138.5×97.5×88.0 mm
(W)×(H)×(D)	Approx. 5.45×3.84×3.46 in.

\* Based on CIPA guidelines.

### Weight

Body (including battery and memory card)	Approx. 738 g	Approx. 26.03 oz.
Body only	Approx. 650 g	Approx. 22.93 oz.

\* Weighed without body cap.

### Operating environment

**Operating temperature:** 0–+40°C / 32–104°F

**Operating humidity:** 85% or less

## Wi-Fi (Wireless LAN) communication

### Compliance standards

Wi-Fi compliance standards	Transmission method	Maximum link speed
IEEE802.11b	DS-SS modulation	11 Mbps
IEEE802.11g	OFDM modulation	54 Mbps
IEEE802.11n		72.2 Mbps
IEEE802.11a		54 Mbps
IEEE802.11ac		86.7/200/433.3 Mbps

### Transmission frequency (Center frequency)

#### 2.4 GHz band

Frequency	2412 to 2462 MHz
Channels	1 to 11 ch

\* Specifications vary by country/region.

#### 5 GHz band

Frequency	5180 to 5825 MHz
Channels	36 to 165 ch

\* Specifications vary by country/region.

### Authentication and data encryption methods

Connection method	Authentication	Encryption
Camera access point	WPA2-PSK	AES
	Open	Disable
Infrastructure	Open	WEP
		Disable
	Shared key	WEP
	WPA-PSK	TKIP AES
	WPA2-PSK	

## Bluetooth

**Compliance standards:** Bluetooth Specification Version 5.0 compliant (Bluetooth Low Energy technology)

**Transmission method:** GFSK modulation

- All data above is based on Canon testing standards and CIPA (Camera & Imaging Products Association) testing standards and guidelines.
- Dimensions and weight listed above are based on CIPA Guidelines (except weight for camera body only).
- Product specifications and appearance are subject to change without notice.
- If a problem occurs with a non-Canon lens attached to the camera, contact the respective lens manufacturer.

# Trademarks and Licensing

---

[✔ Trademarks](#)

[✔ About MPEG-4 Licensing](#)

[✔ Accessories](#)

## Trademarks

---

- Adobe is a trademark of Adobe Systems Incorporated.
- Microsoft and Windows are trademarks or registered trademarks of Microsoft Corporation in the United States and/or other countries.
- App Store and macOS are trademarks of Apple Inc., registered in the U.S. and other countries.
- Google Play and Android are trademarks of Google LLC.
- IOS is a trademark or registered trademark of Cisco in the U.S. and other countries and is used under license.
- QR Code is a trademark of Denso Wave Inc.
- HDMI, HDMI logo, and High-Definition Multimedia Interface are trademarks or registered trademarks of HDMI Licensing LLC.
- The Wi-Fi CERTIFIED logo and the Wi-Fi Protected Setup mark are trademarks of the Wi-Fi Alliance.
- The Bluetooth® word mark and logos are registered trademarks owned by Bluetooth SIG, Inc. and any use of such marks by Canon Inc. is under license. Other trademarks and trade names are those of their respective owners.
- All other trademarks are the property of their respective owners.

## About MPEG-4 Licensing

---

"This product is licensed under AT&T patents for the MPEG-4 standard and may be used for encoding MPEG-4 compliant video and/or decoding MPEG-4 compliant video that was encoded only (1) for a personal and non-commercial purpose or (2) by a video provider licensed under the AT&T patents to provide MPEG-4 compliant video. No license is granted or implied for any other use for MPEG-4 standard."

THIS PRODUCT IS LICENSED UNDER THE AVC PATENT PORTFOLIO LICENSE FOR THE PERSONAL USE OF A CONSUMER OR OTHER USES IN WHICH IT DOES NOT RECEIVE REMUNERATION TO (i) ENCODE VIDEO IN COMPLIANCE WITH THE AVC STANDARD ("AVC VIDEO") AND/OR (ii) DECODE AVC VIDEO THAT WAS ENCODED BY A CONSUMER ENGAGED IN A PERSONAL ACTIVITY AND/OR WAS OBTAINED FROM A VIDEO PROVIDER LICENSED TO PROVIDE AVC VIDEO. NO LICENSE IS GRANTED OR SHALL BE IMPLIED FOR ANY OTHER USE. ADDITIONAL INFORMATION MAY BE OBTAINED FROM MPEG LA, L.L.C. SEE [HTTP://WWW.MPEGLA.COM](http://www.mpegla.com)

\* Notice displayed in English as required.

## Accessories

---

### **Use of genuine Canon accessories is recommended**

This product is designed to achieve optimum performance when used with genuine Canon accessories. Therefore, using this product with genuine accessories is highly recommended. Canon shall not be liable for any damage to this product and/or accidents such as malfunction, fire, etc. caused by the failure of non-genuine Canon accessories (e.g., a leakage and/or explosion of a battery). Please note that repairs arising out of the malfunction of non-genuine accessories will not be covered by the warranty for repairs, although you may request such repairs on a chargeable basis.

#### **Caution**

- Battery Pack LP-E6NH is dedicated to Canon products only. Using it with an incompatible battery charger or product may result in malfunction or accidents for which Canon cannot be held liable.